

## Features

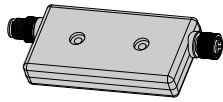

- Rugged waterproof and dustproof overmolded design meets IP65, IP67, and IP68
- Daisy-chain multiple lights with double-ended cables
- Compact space-saving design
- Designed for enclosure, conveyor, machine, or vision lighting

**IMPORTANT:** Read the following instructions before operating the light. Please download the complete WLR95 In-Line Work Light technical documentation, available in multiple languages, from [www.bannerengineering.com](http://www.bannerengineering.com) for details on the proper use, applications, Warnings, and installation instructions of this device.

**IMPORTANT:** Lea el siguiente instructivo antes de operar el luminario. Por favor descargue desde [www.bannerengineering.com](http://www.bannerengineering.com) toda la documentación técnica de los WLR95 In-Line Work Light, disponibles en múltiples idiomas, para detalles del uso adecuado, aplicaciones, advertencias, y las instrucciones de instalación de estos dispositivos.

**IMPORTANT:** Lisez les instructions suivantes avant d'utiliser le luminaire. Veuillez télécharger la documentation technique complète des WLR95 In-Line Work Light sur notre site [www.bannerengineering.com](http://www.bannerengineering.com) pour les détails sur leur utilisation correcte, les applications, les notes de sécurité et les instructions de montage.

## Models

Models	Color	Connection
WLR95WQ	Cool White (6500K)	Integral 4-pin M12 male/female quick-disconnect connector

## Wiring

Male	Female	Pin	Wire Color	Description*
		1	Brown	12 V DC to 30 V DC
		2	White	Not used
		3	Blue	DC Common
		4	Black	Connect to 12 V DC to 30 V DC for 50% of maximum intensity. For 100% intensity, leave the black wire floating or connected to common.

\*Continuity between male and female connection for all four wires.

## Specifications

### Supply Voltage

12 V DC to 30 V DC

Use only with suitable Class 2 power supply (UL) or a SELV power supply (CE)

See electrical characteristics on product label

Typical Current (A)			Maximum Current (A)
12 V DC	24 V DC	30 V DC	
0.485	0.23	0.185	0.5

### Supply Protection Circuitry

Protected against reverse polarity and transient voltages

### Connections

Integral 4-pin M12 male/female quick-disconnect connector

### Construction

Connector: Nickel-plated brass

Housing: TPU clear

Removable cap covering female quick disconnect included

### Vibration and Mechanical Shock

Meets IEC 60068-2-6 requirements (Vibration: 10 Hz to 55 Hz, 1.0 mm amplitude, 5 minutes sweep, 30 minutes dwell)

Meets IEC 60068-2-27 requirements (Shock: 15G 11 ms duration, half sine wave)

Impact: IK06

### Light Characteristics

Color Temperature: 6500K ± 1000K

Lumens: 600

CRI: 80 minimum

### Environmental Rating

IP65, IP67, IP68

UL Type 1

### Required Overcurrent Protection



**WARNING:** Electrical connections must be made by qualified personnel in accordance with local and national electrical codes and regulations.

Overcurrent protection is required to be provided by end product application per the supplied table.

Overcurrent protection may be provided with external fusing or via Current Limiting, Class 2 Power Supply.

Supply wiring leads < 24 AWG shall not be spliced.

For additional product support, go to [www.bannerengineering.com](http://www.bannerengineering.com).

Supply Wiring (AWG)	Required Overcurrent Protection (A)	Supply Wiring (AWG)	Required Overcurrent Protection (A)
20	5.0	26	1.0
22	3.0	28	0.8
24	1.0	30	0.5

### Operating Conditions

**Temperature:** -40 °C to +50 °C (-40 °F to +122 °F)

90% at +50 °C maximum relative humidity (non-condensing)

**Storage Temperature:** -40 °C to +70 °C (-40 °F to +158 °F)

## FCC Part 15 Class B

This equipment has been tested and found to comply with the limits for a Class B digital device, pursuant to part 15 of the FCC Rules. These limits are designed to provide reasonable protection against harmful interference in a residential installation. This equipment generates, uses and can radiate radio frequency energy and, if not installed and used in accordance with the instructions, may cause harmful interference to radio communications. However, there is no guarantee that interference will not occur in a particular installation. If this equipment does cause harmful interference to radio or television reception, which can be determined by turning the equipment off and on, the user is encouraged to try to correct the interference by one or more of the following measures:

- Reorient or relocate the receiving antenna.
- Increase the separation between the equipment and receiver.
- Connect the equipment into an outlet on a circuit different from that to which the receiver is connected.
- Consult the dealer or an experienced radio/TV technician for help.

## Industry Canada ICES-003(B)

This device complies with CAN ICES-3 (B)/NMB-3(B). Operation is subject to the following two conditions: 1) This device may not cause harmful interference; and 2) This device must accept any interference received, including interference that may cause undesired operation.

Cet appareil est conforme à la norme NMB-3(B). Le fonctionnement est soumis aux deux conditions suivantes : (1) ce dispositif ne peut pas occasionner d'interférences, et (2) il doit tolérer toute interférence, y compris celles susceptibles de provoquer un fonctionnement non souhaité du dispositif.

## Dimensions

All measurements are listed in millimeters [inches], unless noted otherwise.

### Dimming

High/Low/Off models: 100/50/0% intensity, dependent on wiring

### LED Lifetime

Lumen Maintenance - L<sub>70</sub>

When operating within specifications, output will decrease less than 30% after 70,000 hours.

### Mounting

Integral through holes for M4 (#8) screws

Multiple bracket options available

### Certifications



Banner Engineering BV  
Park Lane, Culliganlaan 2F bus 3  
1831 Diegem, BELGIUM



Turck Banner LTD Blenheim House  
Blenheim Court  
Wickford, Essex SS11 8YT  
GREAT BRITAIN



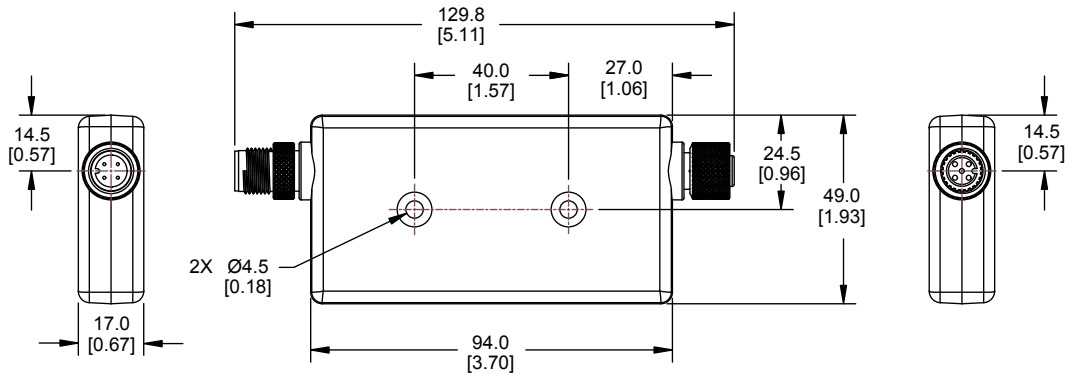

## Photometric Data

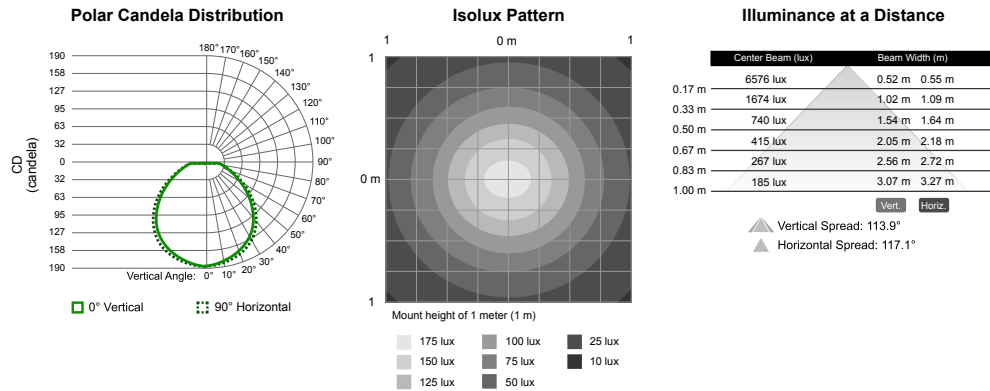

## Accessories

### Cordsets

4-Pin Threaded M12 Cordsets—Single Ended				
Model	Length	Style	Dimensions	Pinout (Female)
MQDC-406	2 m (6.56 ft)	Straight		
MQDC-415	5 m (16.4 ft)			
MQDC-430	9 m (29.5 ft)			
MQDC-450	15 m (49.2 ft)			

1 = Brown  
2 = White  
3 = Blue  
4 = Black  
5 = Unused

Continued on page 4

Continued from page 3

**4-Pin Threaded M12 Cordsets—Single Ended**

Model	Length	Style	Dimensions	Pinout (Female)
MQDC-406RA	2 m (6.56 ft)	Right-Angle		
MQDC-415RA	5 m (16.4 ft)			
MQDC-430RA	9 m (29.5 ft)			
MQDC-450RA	15 m (49.2 ft)			

**4-Pin Threaded M12 Cordsets—Double Ended**

Model	Length	Style	Dimensions	Pinout
MQDEC-401SS	0.31 m (1 ft)	Male Straight/Female Straight		Female
MQDEC-403SS	0.91 m (2.99 ft)			
MQDEC-406SS	1.83 m (6 ft)			Male
MQDEC-412SS	3.66 m (12 ft)			
MQDEC-420SS	6.10 m (20 ft)			<p>1 = Brown 2 = White 3 = Blue 4 = Black</p>
MQDEC-430SS	9.14 m (30.2 ft)			
MQDEC-450SS	15.2 m (49.9 ft)			



**4-Pin Threaded M12 Splitter Cordsets—Flat Junction**

Model	Branches (Female)	Trunk (Male)	Pinout
CSB-M1240M1240	No branch	No trunk	
CSB-M1240M1241	2 x 0.3 m (1 ft)	No trunk	
CSB-M1241M1241		0.30 m (1 ft)	
CSB-M1248M1241		2.44 m (8 ft)	
CSB-M12415M1241		4.57 m (15 ft)	
CSB-M12425M1241		7.60 m (25 ft)	
CSB-UNT425M1241		7.60 m (25.0 ft) Underterminated	
			<p>1 = Brown 2 = White 3 = Blue 4 = Black</p>

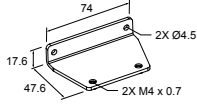
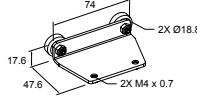
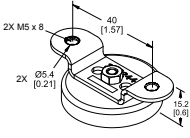
## Brackets

<p><b>SMBR90RA</b></p> <ul style="list-style-type: none"> <li>• Bracket for mounting R90</li> <li>• R90 right-angle</li> <li>• M4 × 0.7 mm</li> <li>• Stainless steel</li> </ul>	
<p><b>SMBR90RAMAG</b></p> <ul style="list-style-type: none"> <li>• R90 right-angle magnetic mount</li> <li>• M4 × 0.7 mm</li> <li>• Stainless steel</li> </ul>	
<p><b>LMBR95MAG</b></p> <ul style="list-style-type: none"> <li>• Magnetic mounting bracket kit for easy attachment to steel and iron surfaces</li> </ul>	

## Other Accessories

<p><b>PSW-24-1</b></p> <ul style="list-style-type: none"> <li>• 24 V DC, 1 A Class 2 UL Listed power supply</li> <li>• 100 V AC to 240 V AC 50/60 Hz input</li> <li>• 2 m (6.5 ft) PVC cable with M12 quick disconnect</li> <li>• Includes Type A (US, Canada, Japan, Puerto Rico, Taiwan), Type C (Germany, France, South Korea, Netherlands, Poland, Spain, Turkey), Type G (United Kingdom, Ireland, Singapore, Vietnam), and Type I (China, Australia, New Zealand) AC detachable input plugs</li> </ul>	
<p><b>ACC-CAP M12-10</b></p> <ul style="list-style-type: none"> <li>• 10 Caps</li> <li>• Seal and protect exposed, unterminated cascade quick-disconnect connectors</li> </ul>	

## Banner Engineering Corp Limited Warranty

Banner Engineering Corp. warrants its products to be free from defects in material and workmanship for one year following the date of shipment. Banner Engineering Corp. will repair or replace, free of charge, any product of its manufacture which, at the time it is returned to the factory, is found to have been defective during the warranty period. This warranty does not cover damage or liability for misuse, abuse, or the improper application or installation of the Banner product.

**THIS LIMITED WARRANTY IS EXCLUSIVE AND IN LIEU OF ALL OTHER WARRANTIES WHETHER EXPRESS OR IMPLIED (INCLUDING, WITHOUT LIMITATION, ANY WARRANTY OF MERCHANTABILITY OR FITNESS FOR A PARTICULAR PURPOSE), AND WHETHER ARISING UNDER COURSE OF PERFORMANCE, COURSE OF DEALING OR TRADE USAGE.**

This Warranty is exclusive and limited to repair or, at the discretion of Banner Engineering Corp., replacement. **IN NO EVENT SHALL BANNER ENGINEERING CORP. BE LIABLE TO BUYER OR ANY OTHER PERSON OR ENTITY FOR ANY EXTRA COSTS, EXPENSES, LOSSES, LOSS OF PROFITS, OR ANY INCIDENTAL, CONSEQUENTIAL OR SPECIAL DAMAGES RESULTING FROM ANY PRODUCT DEFECT OR FROM THE USE OR INABILITY TO USE THE PRODUCT, WHETHER ARISING IN CONTRACT OR WARRANTY, STATUTE, TORT, STRICT LIABILITY, NEGLIGENCE, OR OTHERWISE.**

Banner Engineering Corp. reserves the right to change, modify or improve the design of the product without assuming any obligations or liabilities relating to any product previously manufactured by Banner Engineering Corp. Any misuse, abuse, or improper application or installation of this product or use of the product for personal protection applications when the product is identified as not intended for such purposes will void the product warranty. Any modifications to this product without prior express approval by Banner Engineering Corp will void the product warranties. All specifications published in this document are subject to change; Banner reserves the right to modify product specifications or update documentation at any time. Specifications and product information in English supersede that which is provided in any other language. For the most recent version of any documentation, refer to: [www.bannerengineering.com](http://www.bannerengineering.com).

For patent information, see [www.bannerengineering.com/patents](http://www.bannerengineering.com/patents).

## Mexican Importer

Banner Engineering de México, S. de R.L. de C.V. | David Alfaro Siqueiros 103 Piso 2 Valle oriente | San Pedro Garza Garcia Nuevo León, C. P. 66269

81 8363.2714