

DX80 Performance Wireless IO Networks



Original Instructions
p/n: 132607 Rev. R
September 13, 2023

© Banner Engineering Corp. All rights reserved.

Contents

Contents	2
Chapter 1 Sure Cross® DX80 Performance Wireless Networks	
Gateways and Nodes	5
Host Controller Systems	6
What is FlexPower®?	6
DX80 Performance Configuration Software	7
Chapter 2 Features	
DX80 Gateway and Node Components	9
DX80 Gateway and Node Wiring Chamber	10
Dimensions	10
Gateways and Nodes Dimensions	11
DX80C Gateways and Nodes Dimensions	11
DX80E Housings Dimensions	12
Chapter 3 Setting Up Your Wireless Network	
Mixing Performance and Non-Performance (150 mW) Radios in the Same Network	13
Apply Power to the Gateway or Node	14
DX80..C Wiring	15
4-pin M12 D-Coded Industrial Ethernet Wiring	15
Bind Radios to Form Networks	15
LED Behavior for the Gateways and Nodes	16
Conducting a Site Survey (Gateway and Nodes)	17
Conduct a Site Survey Using the Menu System	17
Conduct a Site Survey from a Gateway Board Model	18
Conduct a Site Survey Using Modbus Commands	18
Example Command	19
Site Survey Data Holding	19
Conduct a Site Survey from the DXM	20
Interpreting the Site Survey Results	20
Chapter 4 Installing Your Sure Cross® Radios	
Mounting Sure Cross Devices Outdoors	23
Watertight Glands and NPT Ports	23
Other Installation Requirements	24
Installation Quick Tips	24
Create a Clear Communication Path	24
Increase the Height of the Antennas	24
Collocated Radios	25
Be Aware of Seasonal Changes	25
Installing a Basic Remote Antenna	26
Weatherproof Remote Antenna Installations	27
Installing Remote Antennas	27
Mount a Dome Antenna to the Enclosure	28
Use an N-Type, Pole-Mounted Antenna	29
Chapter 5 Advanced Setup Options	
DX80 Menu Structure	31
RUN Menu	34
DINFO (Device Information) Menu	34
FCTRY (Factory) Menu	35
SITE (Site Survey) Menu	18
DVCFG (Device Configuration) Menu	36
DERR (Device Error) Menu	38
Binding Mode: What does it do?	38
Automatic Binding Using the Menu Navigation	38
Bind Radios Using Modbus Commands	39
Setting the Network ID in Extended Addressing Mode	40
Manually Assign a Binding Code to a Gateway	40
Manually Assign a Binding Code to a Node	41
Setting the Maximum System Devices	42

Storage and Sleep Modes	42
Modbus Holding Registers	42
Modbus Communication Parameters	43
Set the Slave ID on a DX80 Gateway.....	43
Set the Baud Rate	43
Set the Parity	44
Default Output Conditions	44
Host Link Failure.....	44
Gateway Link Failure	45
Node Link Failure.....	45
Defining the Units	46
Input Units.....	46
Output Units	46
Interpreting Register Values in the Banner Wireless System	47
Signed Numbers	48
Mapping Unit Types	48
Example: Mapping a Temperature.....	49
Example: Mapping a Distance	49

Chapter 6 Product Support and Maintenance

DX80 Performance Documentation	51
Troubleshooting.....	51
Startup Problems	51
LED Message Codes	52
LCD Message Codes.....	53
Inputs and Outputs	54
Radio Link Time-Out and Recovery (Non-Host Connected Systems).....	54
Maintenance.....	55
Replacing the Main Body Gasket	55
Replacing the Rotary Dial Access Cover	56
Install or Replace the Battery for a DX81 Model.....	56
Install or Replace the Battery for a DX80 Integrated Battery Model.....	57
Install or Replace the Battery (DX99...D Models).....	58
Sure Cross® Radio Certifications.....	58
FCC Part 15 Class A for Intentional Radiators.....	58
Industry Canada Statement for Intentional Radiators.....	59
FCC and ISED Certification, 900 MHz, 1 Watt Radios	59
FCC Notices.....	59
FCC and ISED Approved Antennas	59
FCC and ISED Certification, 2.4GHz	60
FCC Notices.....	60
FCC and ISED Approved Antennas	61
Exporting Sure Cross® Radios.....	61
International Certifications for Sure Cross® Radios	61
Contact Us.....	62
Warnings.....	62
Banner Engineering Corp Limited Warranty	63
.....	63

Blank page

Chapter Contents

Gateways and Nodes	5
Host Controller Systems.....	6
What is FlexPower®?	6
DX80 Performance Configuration Software	7

Chapter 1 Sure Cross® DX80 Performance Wireless Networks

The Sure Cross DX80 Performance wireless I/O network provides reliable monitoring without wiring or conduit installation. The network operates independently or in conjunction with a host system, PLC, and/or PC software. Each wireless network system consists of one Gateway and one or more Nodes, and devices ship with factory-defined discrete, analog, or a mix of discrete and analog inputs and outputs.

The Sure Cross DX80 Performance network is a deterministic system—the network identifies when the radio signal is lost and drives relevant outputs to user-defined conditions. After the radio signal is reacquired, the network returns to normal operation.

Sure Cross DX80 Performance wireless network

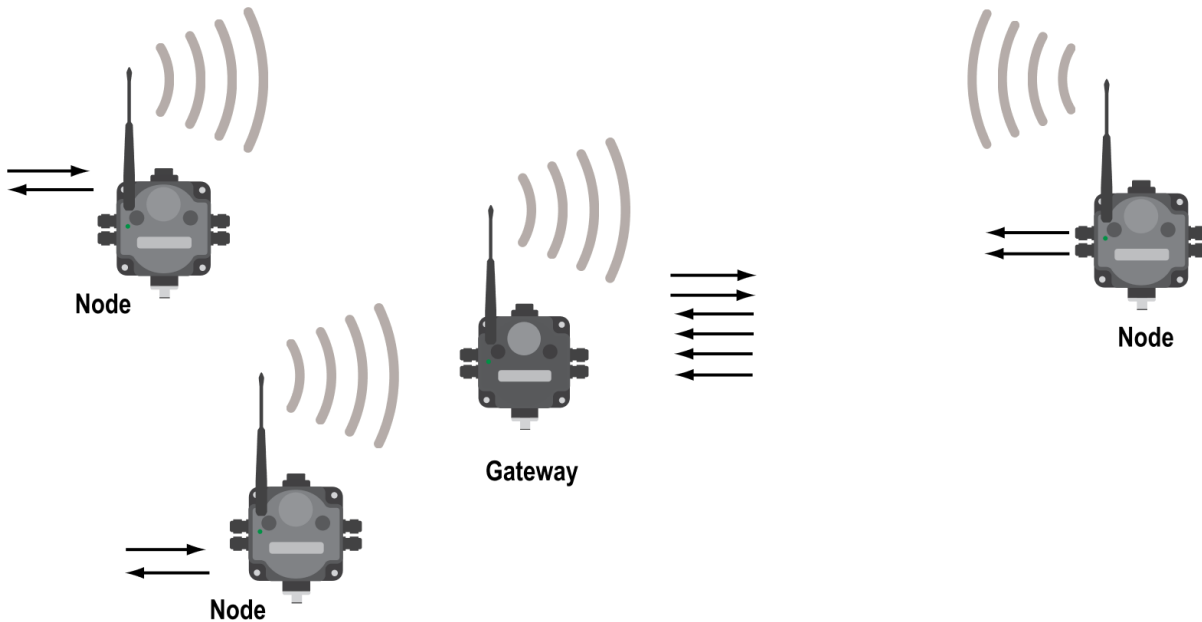

Gateways and Nodes

Every wireless network must have one Gateway, which schedules communication traffic and controls the I/O configuration for the network, and one or more Nodes.

A **Gateway** is the master device within each radio network. Similar to how a gateway device on a wired network acts as a “portal” between networks, the Sure Cross Gateway acts as the portal between the wireless network and the host controller. When the Gateway, using its Modbus RTU RS-485 connection, is a Modbus slave to a Modbus RTU host controller, the wireless network may contain up to 47 Nodes in a single wireless network. The Gateway holds the Modbus registers of all wireless devices within the network.

A **Node** is a wireless network end-point device used to provide sensing capability in a remote area or factory. The Node collects data from sensors and communicates the data back to the Gateway. Nodes are available in a wide variety of power or input/output options.

Gateways and Nodes

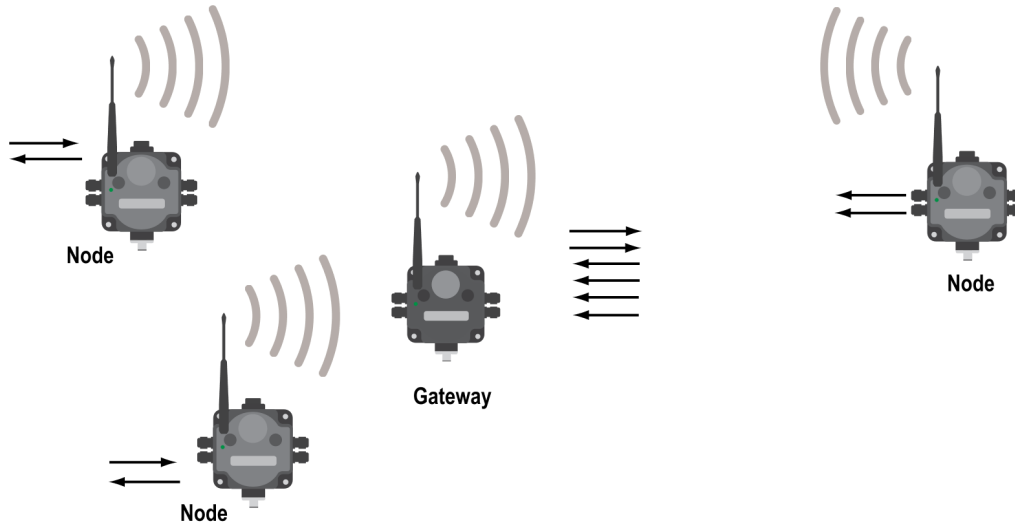

Host Controller Systems

Host controller systems collect I/O data for logging, controlling other devices, or performing calculations.

Host controller systems can contain up to 47 Nodes (when using Extended Addressing Mode) within a single network. Inputs from Nodes within the network are transmitted to the Gateway, which communicates the information to a host system for processing. Although the Gateway is the master device within the radio network, it may be a slave to the Modbus network.

What is FlexPower®?

Banner's FlexPower technology supplies a true wireless solution by allowing the device to operate using either 10 to 30 V dc, 3.6 V lithium D cell batteries, or solar power. This unique power management system can operate a FlexPower Node and an optimized sensing device for up to five years on a single lithium D cell.

- FlexPower Nodes may be powered from 10 to 30 V DC and use an external battery supply module to provide a battery back-up solution.
- When a FlexPower Node receives 10 to 30 V DC, it operates like a standard 10 to 30 V DC Node.
- Good applications for FlexPower devices operating from batteries include sensors that require no or very little power, including dry contacts, RTDs, and thermocouples.

The following FlexPower options are available:

- DX81-LITH, a single battery supply module;
- DX81P6, a 6-pack of lithium batteries;
- DX81H, a single battery supply module designed specifically to power the DX99 Intrinsically Safe devices with polycarbonate housings; and
- BWA-SOLAR PANEL 3W, 5W, or 20W, solar panel assemblies.

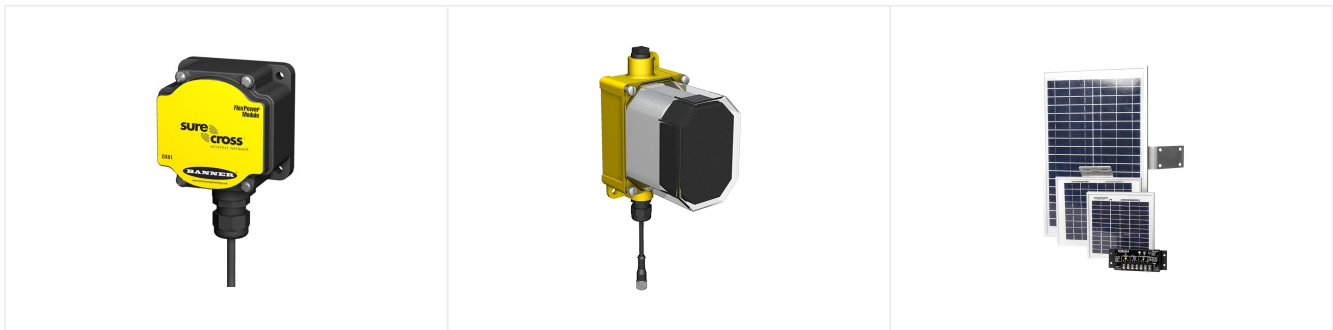

Continued on page 7

Continued from page 6

<p>DX81-LITH: Single battery supply module DX81H: Single battery supply module designed specifically to power the DX99 Intrinsically Safe devices with polycarbonate housings</p>	<p>DX81P6: Six-pack battery supply module</p>	<p>BWA-SOLAR PANEL 3W, BWA-SOLAR PANEL 5W, or BWA-SOLAR PANEL 20W: Includes 3 W, 5 W, or 20 W solar panel. Order the solar controller (model BWA-Solar CNTRL-12V) separately when you are not using the solar panel with a DXM Wireless Controller. For more information about solar power solutions, see <i>Sure Cross® Solar Solutions</i>.</p>
---	---	---

DX80 Performance Configuration Software

The configuration software offers an easy way to link I/O points in your wireless network, view I/O register values, and set system communication parameters when a host system is not part of the wireless network. The software runs on any computer with the Windows Vista, Windows 7, Windows 8, or Windows 10 operating system.

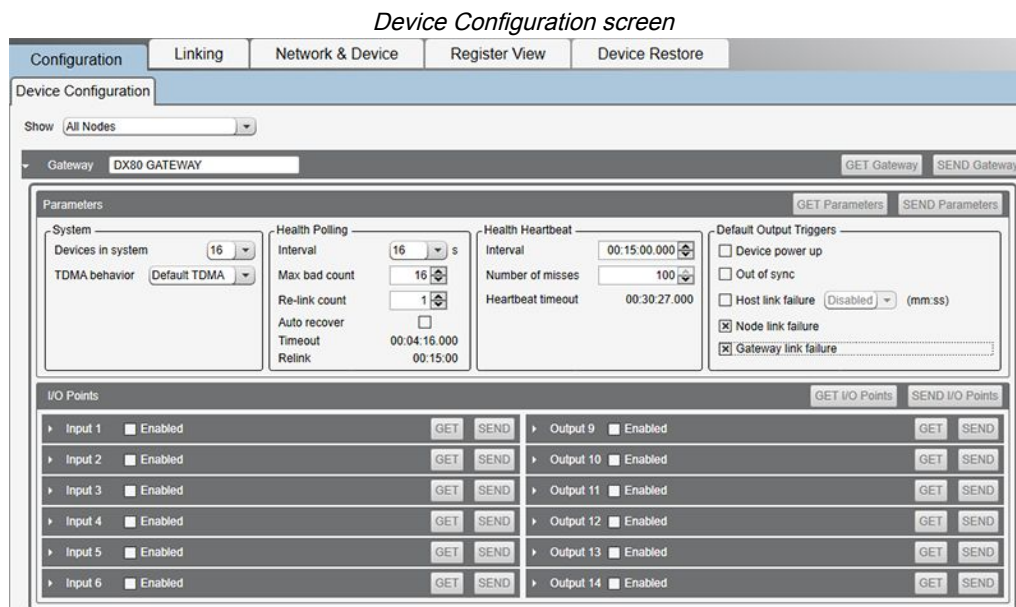

Use a USB to RS-485 adapter cable to connect a standalone DX80 Gateway to the computer. For DXM Controllers with an internal DX80 radio, connect a computer to the DXM Controller using the supplied USB or Ethernet connection. Download the most recent revisions of the configuration software from Banner Engineering's website: <https://www.bannerengineering.com/us/en/products/wireless-sensor-networks/reference-library/software.html>.

The USB to RS-485 adapter cable is not required for the DXM Controller. For standalone DX80 Gateway devices use:

- USB to RS-485 adapter cable model **BWA-UCT-900** for 1 Watt radios
- USB to RS-485 adapter cable model **BWA-HW-006** for all other radios

Blank page

Chapter Contents

DX80 Gateway and Node Components	9
DX80 Gateway and Node Wiring Chamber.....	10
Dimensions.....	10

Chapter 2 Features

The following feature callouts refer to the DX80 Gateway and Node models. The wiring diagrams include information for connection power and sensors using the 5-pin M12 connector, the terminal wiring board, and any other applicable connection.

DX80 Gateway and Node Components

The DX80 Gateway and Node use the same housing and include the same physical features.

Features of the Performance Gateway and Node



1. Port, NPT gland, or plug—If unused, install the provided plug into the 1/2 NPT threaded port. Refer to the Installation section if an IP67 seal is required.
2. Rotary switch 1 (left)—In Rotary Dial Addressing Mode, sets the Network ID (NID) to a hexadecimal value from 0 to F, for a total of 16 Network IDs. A Gateway and its corresponding Nodes must be assigned the same Network ID. Rotary switch 2 (right)—On the Gateway, sets the Gateway's LCD viewing device address. The Gateway is predefined as Device Address 0. On the Node, sets the Node's Device Address (hexidecimal 1 to F). Each Node within a network must have a unique Node Device Address.
3. Push button 1—Single-click to advance across all top-level DX80 menus. Single-click to move down interactive menus, once a top-level menu is chosen. Button 1 is also used to wake integrated battery models from the hibernation mode they ship in.
4. Push button 2—Double-click to select a menu and to enter manual scrolling mode. Double-click to move up one level at a time.
5. LED 1 and 2—Provide real-time feedback to the user regarding RF link status, serial communications activity, and the error state.
6. LCD Display—Six-character display provides run mode user information and shows enabled I/O point status. This display allows the user to conduct a Site Survey (RSSI) and modify other DX80 configuration parameters without the use of a PC or other external software interfaces. On the Node, after 15 minutes of inactivity, the LCD goes blank. Press any button to refresh the display.
7. 5-Pin M12 quick-disconnect serial port

DX80 Gateway and Node Wiring Chamber

The DX80 Gateway and Node use the same housing and terminal block for wiring.

Wiring chamber of the Performance Gateway and Node

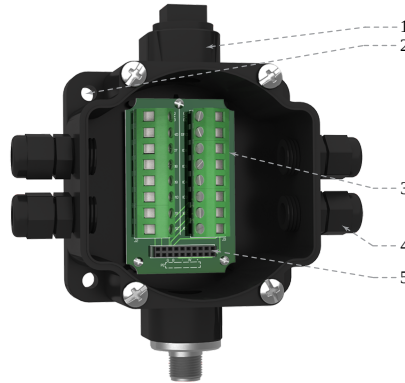

1. Housing—The rugged, industrial DX80 housing meets IEC IP67 standards.
2. Mounting hold, #10/M5 clearance—Mounting Holes accept metric M5 or UNC/UNF #10 hardware; DIN rail mount adapter bracket available.
3. Wiring terminal strip—The 16 spring-clip type wiring terminals accept wire sizes: AWG 12-28 or 2.5 sq mm.
4. Port, PG-7 gland or blank—The PG-7 threaded ports can accept provided cable glands or blanks.
5. Ribbon connector—Ribbon cable connects wiring base to LCD/radio.

Dimensions

The DX80, DX83, and DX70 models all share the same housing and mounting hole dimensions.

Gateways and Nodes Dimensions

All measurements are listed in millimeters, unless noted otherwise.

Dimensions for the Performance Gateway and Node

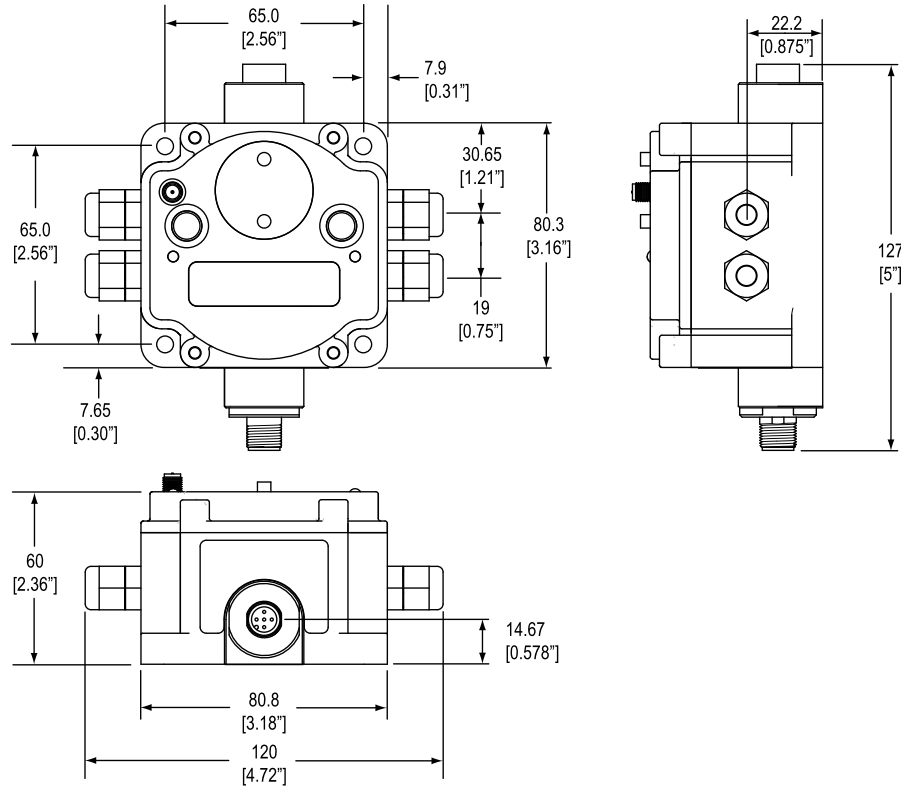

DX80C Gateways and Nodes Dimensions

All measurements are listed in millimeters, unless noted otherwise.

Dimensions for the C housing models

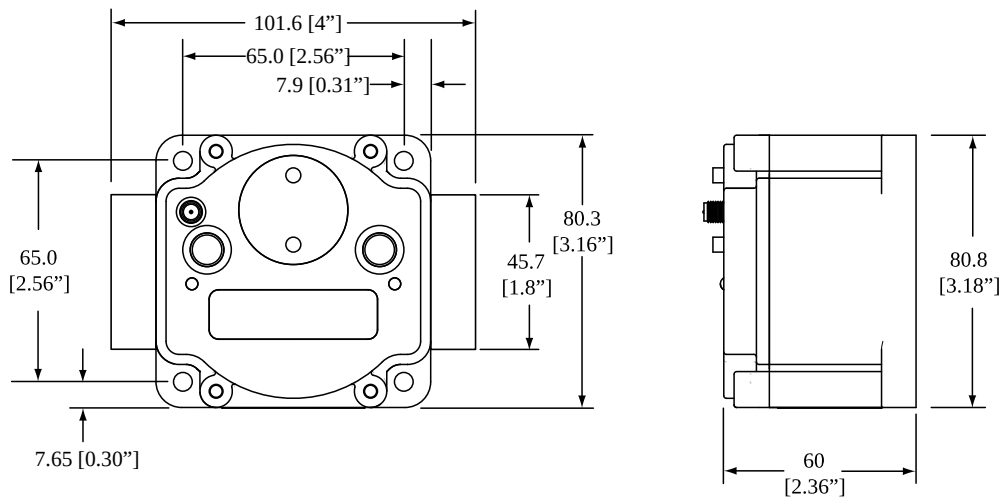

DX80E Housings Dimensions

All measurements are listed in millimeters, unless noted otherwise.

DX80...E Housing

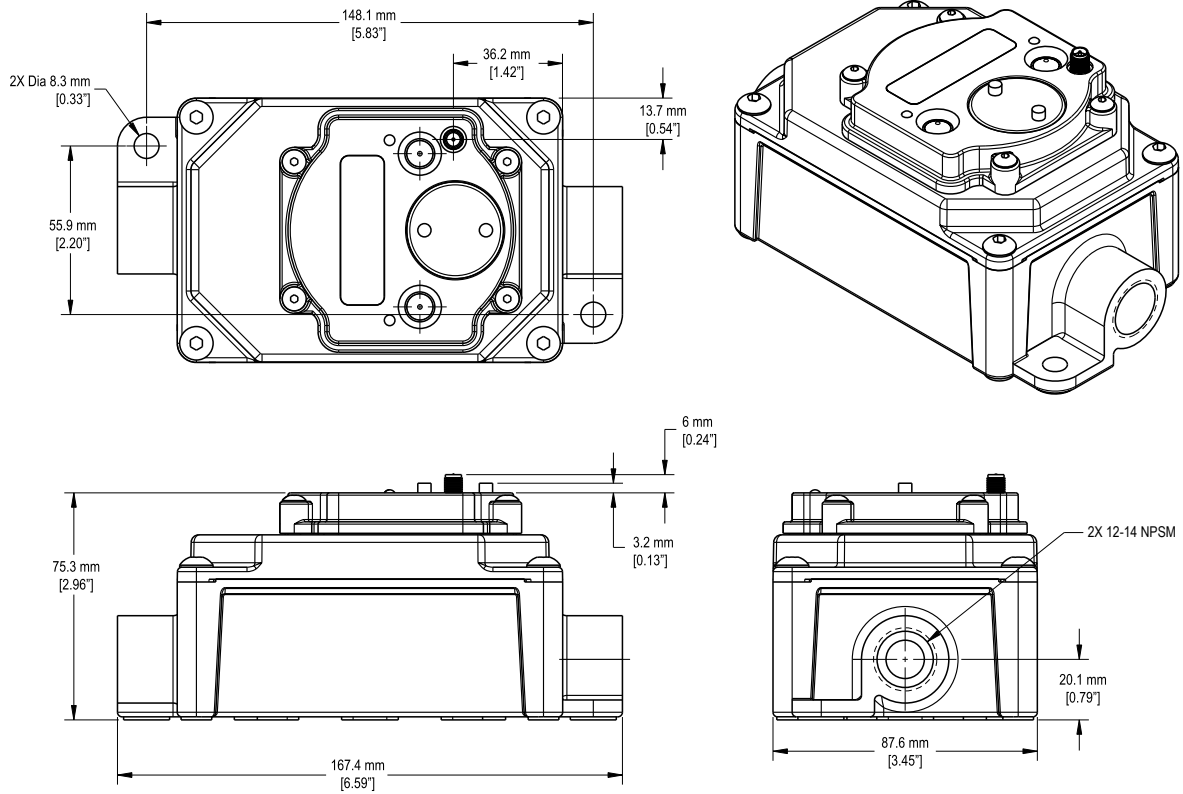

Chapter Contents

Mixing Performance and Non-Performance (150 mW) Radios in the Same Network	13
Apply Power to the Gateway or Node	14
Bind Radios to Form Networks.....	15
LED Behavior for the Gateways and Nodes.....	16
Conducting a Site Survey (Gateway and Nodes).....	17

Chapter 3 Setting Up Your Wireless Network

To set up and install your wireless network, follow these steps.

1. Disconnect the power from your Sure Cross® devices.
2. Configure the DIP switches of all devices. DIP switch configurations are always listed in the product's datasheet.
3. If your device has I/O, connect the sensors to the Sure Cross devices. Available I/O is always listed in the product's datasheet. If your device does not have I/O, skip this step.
4. Refer to the wiring diagrams to apply power to all devices.
 - For housed models, the Gateway's LED 1 is solid green and the Node's LED 2 flashes red to indicate there is no radio link to the Gateway.
 - For board-level models, the Gateway's LED is solid green and the Node's LED flashes red to indicate there is no radio link to the Gateway.
5. Form the wireless network by binding the Nodes to the Gateway.
6. Observe the LED behavior to verify the devices are communicating with each other.
 - For housed models, the Gateway's LED 1 is solid green and the Node's LED 1 flashes green to indicate it is communicating with the Gateway.
 - For board-level models, the Gateway's LED is solid green and the Node's LED flashes green to indicate it is communicating with the Gateway.
7. Configure any I/O points to use the sensors connected to the Sure Cross devices.
8. Conduct a site survey between the Gateway and Nodes.
9. Install your wireless sensor network components.

Mixing Performance and Non-Performance (150 mW) Radios in the Same Network

To comply with federal regulations, the 150 mW radios and 1 Watt radios communicate differently. All Performance models offer the ability to select between 250 mW and 1 Watt operation using the DIP switches.

To mix Performance radios with non-Performance radios, refer to the product datasheet and:

- Operate Performance radios in 250 mW mode, not 1 Watt mode
- Set non-Performance (150 mW) radios to use Extended Address Mode

The 150 mW, 250 mW, and 1 Watt networks operate when collocated, but verify the antenna separation distance between a Gateway and Node or between two Gateways is at least 10 feet apart. For more detailed instructions about setting up your wireless network, refer to the following documents:

- DX80 Performance Quick Start Guide (p/n [128185](#))
- DX80 Performance Wireless I/O Network Instruction Manual (p/n [132607](#))
- DXM Quick Start Guide (p/n [191247](#))
- DXM Instruction Manuals (DXM100-Bx: [190037](#) and DXM150-Bx: [190038](#))

Performance radio network with Gateway and Nodes

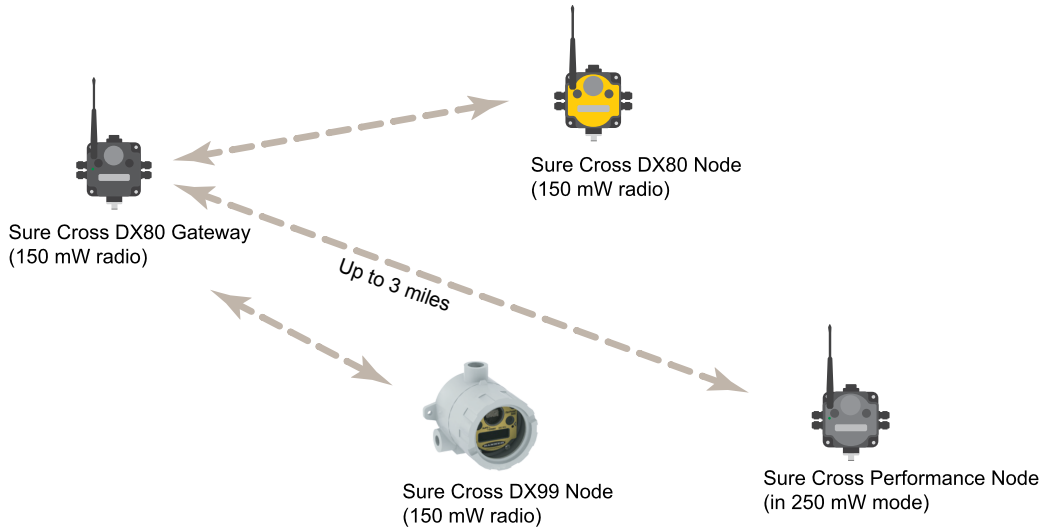

Performance radio network with a DXM and Nodes

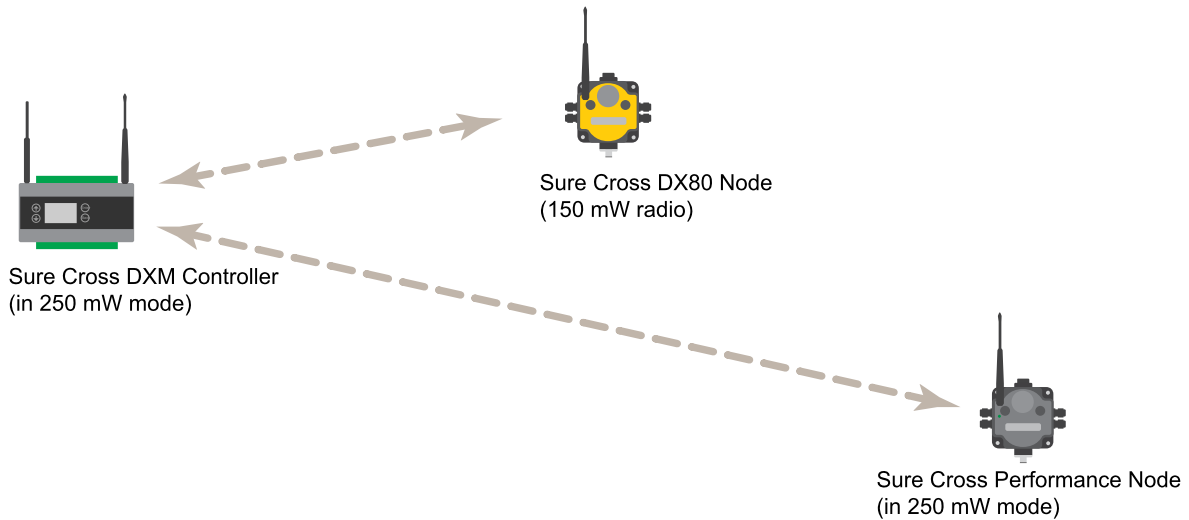

Apply Power to the Gateway or Node

Integral 5-pin M12 male quick-disconnect connector wiring depends on the model and power requirements of the device. Not all models can be powered by 10 V DC to 30 V DC and not all models can be powered by 3.6 V DC to 5.5 V DC. Refer to your specific device's specifications to verify the power requirements of your device.

5-pin M12 wiring for the Gateway and Nodes

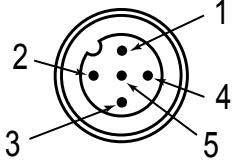
5-pin M12 Connector	Pin	Wire Color	Gateway (10 V DC to 30 V DC)	Node (10 V DC to 30 V DC)	Node (FlexPower)
	1	brown	10 V DC to 30 V DC input	10 V DC to 30 V DC	
	2	white	RS485 / D1 / B / +		
	3	blue	DC common (GND)	DC common (GND)	DC common (GND)
	4	black	RS485 / D0 / A / -		
	5	gray	Comms ground		3.6 V DC to 5.5 V DC ⁽¹⁾

- Apply power to the Gateway by connecting the 10 V DC to 30 V DC cable as shown.
The Gateway begins in RUN mode, displays the current network ID (NID), then identifies itself as a Gateway.
- Apply power to the Node by connecting the 10 V DC to 30 V DC cable or the DX81 Battery Supply Module as shown.
To apply power to a FlexPower Node with an integrated battery, install the battery into the housing.
The Node starts in RUN mode, displays the current network ID, then identifies itself as a Node and lists its device ID.

DX80...C Wiring

Wiring power to the DX80...C models varies depending the power requirements of the model. Connecting DC power to the communication pins (Tx/Rx) causes permanent damage. For *FlexPower* devices, do not apply more than 5.5 V to the B+ terminal.

Wiring for the C housing models

Terminal Label	Gateway and DX85	10 V DC to 30 V DC Powered Nodes	Battery-Powered Nodes
V+	10 V DC to 30 V DC	10 V DC to 30 V DC	
Tx/+	RS485 / D1 / B / +		
V-	DC common (GND)	DC common (GND)	DC common (GND)
Rx/-	RS485 / D0 / A / -		
B+			3.6 V DC to 5.5 V DC

4-pin M12 D-Coded Industrial Ethernet Wiring

Use the 4-pin M12 D-Coded industrial Ethernet connection to connect the radio network to an Ethernet-based host system.

4-pin wiring for the D-coded Ethernet connector

4-pin Industrial Ethernet Connector (female)	Pin	Wire Color	Description
	1	White/orange	+ Tx
	2	White/blue	+Rx
	3	Orange	-Tx
	4	Blue	-Rx

Bind Radios to Form Networks

Binding Nodes to a Gateway ensures the Nodes only exchange data with the Gateway they are bound to. For a more detailed definition of binding mode, refer to the *Advanced Setup* section of the *Sure Cross Wireless I/O Networks* instruction manual.

Apply power to the Gateway and Nodes.

- Enter binding mode on the Gateway.

⁽¹⁾ For FlexPower devices, do not apply more than 5.5 V DC to the gray wire.

- If you have a two-button Gateway, triple-click button 2
- If you have a one-button Gateway, triple-click the button
- If you have a Gateway with no buttons, remove the rotary dial access cover and set both the right and left rotary dials to 0, then set both the right and left rotary dials to F.
- If you have a DXM, under the **ISM Radio** menu, use the down arrow button to highlight the **Binding** menu. Click **ENTER**.



The LEDs flash alternately when the Gateway is in binding mode. Any Node entering binding mode will bind to this Gateway.

2. Use the Node's rotary dials to assign a valid decimal Node Address (between 01 and 47). The left rotary dial represents the tens digit (0 through 4) and the right dial represents the ones digit (0 through 9) of the Node Address.
3. Enter binding mode on the Node.
 - If you have a two-button Node, triple-click button 2.
 - If you have a one-button Node, triple-click the button.
 - If you have a Node with no buttons, remove the top cover and set both the left and right rotary dials to F to enter binding mode. ⁽¹⁾

The Node enters binding mode and locates the Gateway in binding mode.

For two LED models, the red LEDs flash alternately. After binding is complete, both LEDs are both solid red for a few seconds.

For one-LED models, the red and green LED flashes alternately while the Node searches for the Gateway. After binding is complete, the LED is red and green for four seconds (looks amber), then the red and green flash simultaneously (looks amber) four times.

The Node automatically exits binding mode, cycles its power, then enters RUN mode.

4. For DXM models, click **BACK** to exit binding for that specific Node address.
5. Repeat steps 2 through 4 for all Nodes that will communicate to this Gateway.
6. Exit binding mode on the Gateway.
 - If you have a two-button Gateway, single-click either button.
 - If you have a one-button Gateway, single-click the button.
 - If you have a Gateway with no buttons, change the Gateway's rotary dials to a valid Network ID.
 - If you have a DXM, click **BACK** until you return to the main menu.

When installing special kits with pre-mapped I/O, indicated by device model numbers beginning in DX80K, return the rotary dials to their original positions after binding. If the rotary dials are not returned to their original positions, the I/O mapping will not work.

LED Behavior for the Gateways and Nodes

Verify all devices are communicating properly. Nodes do not sample inputs until they are communicating with the Gateway. The radios and antennas must be a minimum distance apart to function properly. Recommended minimum distances are:

- 900 MHz 150 mW and 250 mW radios: 6 feet
- 900 MHz 1 Watt radios: 15 feet
- 2.4 GHz 65 mW radios: 1 foot

⁽¹⁾ Some older M-GAGE Nodes (models DX80N*X1W0P0ZR) may require F-F binding despite having a single button. Refer to the Node's datasheet for specific information.

LED behavior

Devices with Two LEDs		Devices with One LED	Gateway Status	Node Status
LED 1	LED 2			
Green		Green	Power is on	N/A
Flashing green			N/A	Radio link is okay
Flashing red	Flashing red	Flashing red	Device error	Device error
	Flashing amber	Green and red flash (amber) together	Modbus communication active	N/A
	Flashing red	Flashing red	Modbus communication error	No radio link (flashes once every 3 s)
Flashing red (alternately)	Flashing red (alternately)	Green and red flash alternately	Device is in binding mode	Device is in binding mode
		Red	Gateway is trying to conduct a Site Survey with a Node that doesn't exist	
		Green and red solid (amber) together	No radio communication detected	
Red (4 s)	Red (4 s)	Green/red solid (amber) for 4 seconds, then flash 4 times		Binding mode is complete

For Gateway systems, the Modbus communication LEDs refer to the communication between the Gateway and its host system (if applicable). For Gateway and Ethernet Bridge systems, active Modbus communication refers to the communication between the Gateway and the Ethernet Bridge. For GatewayPro systems, the Modbus communication LEDs refer to the communication internal to the GatewayPro.

Conducting a Site Survey (Gateway and Nodes)

A Site Survey, also known as a Radio Signal Strength Indication (RSSI), analyzes the radio communications link between the Gateway and any Node within the network by analyzing the radio signal strength of received data packets and reporting the number of missed packets that required a retry.

Perform a Site Survey before permanently installing the radio network to ensure reliable communication. Activate Site Survey mode from either the Gateway buttons or the Gateway Modbus holding register 15. Only the Gateway can initiate a Site Survey, and the Site Survey analyzes the radio communications link with one Node at a time.

Conduct a Site Survey Using the Menu System

Initiate a Site Survey using the Gateway's buttons and menu system.

1. Remove the Gateway's rotary dial access cover.
2. Set the Gateway's rotary dials to the desired Node number.
For example, to check the status of Node 1, set the Gateway's left rotary dial to 0 and the right rotary dial to 1. To check the status of Node 32, set the Gateway's left rotary dial to 3 and the right rotary dial to 2.
The Gateway is now enabled to read the status of the selected Node. The display scrolls through the Node's I/O status.
3. Single-click button 1 to scroll across the menu levels until reaching the Site Survey (SITE) menu.
4. Single-click button 2 to enter the Site Survey menu.
5. Single-click button 2 to begin conducting a Site Survey with the Node selected in step 2.
The Gateway analyzes the quality of the signal from the selected Node by counting the number of data packets it receives from the Node.
6. Examine reception readings (M, R, Y, G) of the Gateway at various locations.
Site survey results display as a percentage. M represents the percent of missed packets while R, Y, and G represent the percent of received packets at a given signal strength.
M = Percent of missed packets; R = RED marginal signal; Y = YELLOW good signal; G = GREEN excellent signal.
Record the results if you need troubleshooting assistance from the factory.
7. Change the Gateway's rotary dials to conduct a Site Survey with another Node and repeat steps 2 through 6.
8. To end the Site Survey, double-click the Gateway's button 2.
9. Change the Gateway's rotary dials back to 0.
The LCD displays the device readings for the Gateway.
10. Double-click button 2 to move back to the top level menu.

11. Single-click button 1 to return to RUN mode.
12. Install the rotary dial access cover, referring to the Installation section of the manual to create an IP67 seal.

SITE (Site Survey) Menu

The **SITE** menu displays the results of a Site Survey conducted with this Gateway.

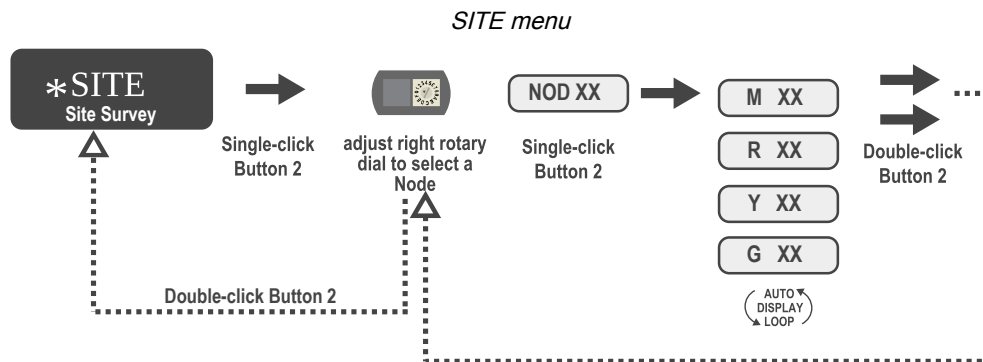

The **SITE** menu displays the device number of the Node the Site Survey was conducted with as well as the missed, green, yellow, and red received packet count. The **SITE** menu is only available on the Gateways. To access the **SITE** menu, single-click button 1 to scroll across the menu levels until reaching the Site Survey (**SITE**) menu.

See ["Conduct a Site Survey Using the Menu System" on page 17](#).

See ["Interpreting the Site Survey Results" on page 20](#).

Conduct a Site Survey from a Gateway Board Model

Conducting a Site Survey, also known as an RSSI (Radio Signal Strength Indication), analyzes the radio communications link between the Gateway and any Node within the network by analyzing the radio signal strength of received data packets and reporting the number of missed packets that required a retry.

Perform a Site Survey before permanently installing the radio network to ensure reliable communication. Only the Gateway can initiate a Site Survey, and the Site Survey analyzes the radio communications link with one Node at a time. Follow these steps to conduct a Site Survey from the board module Gateway.

1. Set the Gateway's rotary dials to the Node address you'd like to conduct a Site Survey with.
For example, to analyze the signal strength between this Gateway and Node 02, rotate the left rotary dial to 0 and the right rotary dial to 2.

The Site Survey automatically begins running. If there is no device at address 02, the LED is solid red. If there is a device at address 02, the LED flashes amber.

2. Evaluate the signal strength. The amber LED flashes at specific rates to indicate the Site Survey results. Each signal strength represents the majority of the data packets being received at that signal strength. For example, a strong signal strength indicates the majority of the data packets were received at a strong signal, but a few may have been received at a good or weak signal strength.
 - Eight flashes per second: Very strong signal strength
 - Four flashes per second: Strong signal strength
 - Two flashes per second: Good signal strength
 - One flash per second: Weak signal strength
 - Solid amber LED: No radio communication detected
3. To exit the Site Survey, set the Gateway's rotary dials to 00. Otherwise, after 15 minutes the Gateway automatically exits Site Survey mode.

The LED flashes green to indicate the Gateway is in standard operating mode.

Conduct a Site Survey Using Modbus Commands

Use Modbus commands sent from the host system to start a Site Survey.

To start a Site Survey using a Modbus write holding register command, send a control code of 32 (0x20) and the Node number 1 through 47 (0x01 to 0x2F) to the Gateway Modbus holding register for I/O 15.

Modbus commands for I/O 15

	Modbus Register	
	[15:8]	[7:0]
I/O 15	Control Code	Data Field

I/O 15 control messages

I/O 15 Control Messages			
Control Code	Data Field	Restrictions	Description
32	Node # 1–15	Gateway only	Enable Site Survey between Gateway and Node defined by the data field. All error messages from the Gateway are ignored when running Site Survey. Only one Node can participate in Site Survey at a time. To disable the Site Survey, use control code 0x20 with Node 0. A Node must be enabled to run the Site Survey, then disabled before selecting the next Node.

Example Command*Example Modbus command for I/O 15*

	Modbus Register	
	[15:8]	[7:0]
I/O 15	32	02

When Site Survey runs, the accumulated results are stored in the Gateway's I/O 7 and I/O 8 holding registers. The LEDs on the both the Gateway and the Node's front panel display the signal strength for the wireless RF link. The quality of the communications link is indicated by:

- Green LED = excellent signal strength
- Amber LED = good signal strength
- Red LED = poor signal strength

The signal strength is the transmitted signal strength relative to the ambient RF signal present in a specific location, or noise floor.

The Gateway also displays the Site Survey results on the LCD (for models with an LCD). For one transmit and receive interval, the Gateway saves the lowest signal strength. The LCD and Modbus registers contain the results of the last 100 samples. The totals are a running tally of the last 100 samples and are continuously updated. Four categories are displayed:

- G (green) = excellent signal strength
- Y (yellow) = good signal strength
- R (red) = poor signal strength
- M = Missed packet

To disable Site Survey, send control code 32 (0x20) and Node number 0 (0x0), which is represented as 8192 (0x2000).

Site Survey Data Holding

With Site Survey active, registers I/O 7 and 8 are Site Survey data holding registers that store the accumulated Site Survey results. Error collections in holding register 8 are saved when Site Survey runs and restored after Site Survey is disabled.

Site survey registers and example results

	Register		Example Results	
	[15:8]	[7:0]	[15:8]	[7:0]
I/O 7	Red Total	Missed Total	10	0
I/O 8	Green Total	Yellow Total	80	10

NOTE: This is the current register arrangement when using Modbus/TCP or Modbus RTU. In some older models, the Modbus/TCP registers are reversed (missed and yellow totals are in [8:15], red and green totals are in [0:7]).

Conduct a Site Survey from the DXM

Conduct a Site Survey to verify the wireless communication between the radios within your wireless network. Conduct the site survey when the Nodes and DXM Controller are at the proposed installation sites to determine each radio's signal strength with the DXM.

For a DX80 network, the Gateway controls the site survey and the results display on the LCD. Running a site survey on a DX80 network does not affect the throughput of the DX80 network. The DX80 Gateway-Node system can run a site survey analysis while the network is operational. For a MultiHop network, the client device passes the site survey request to the intended Modbus server device. The Site Survey runs and the results display on the LCD. Running a site survey on a MultiHop network stops all network traffic to that device.





1. On the DXM: Use the arrow buttons to select the **ISM Radio** menu and press **ENTER**.
2. Select the **Site Survey** menu and press **ENTER**.
3. Use the Up or Down arrows to select the device ID number and press **ENTER** to run the site survey with that radio.
The site survey results display as green, yellow, red, and missed packets. Green indicates the highest signal strength, then yellow, and red. Missed packets were not received.
4. When you are finished running the Site Survey, press **Back** twice to return to the main menu and exit site survey mode.

If the Site Survey fails (100 missed packets), verify the radios are at least 10 feet from the DXM and/or rerun the binding procedure. If you find poor signal quality, common solutions include moving the DXM to a more central location relative to the Nodes or using higher-gain antennas on the DXM. Contact your local Banner Engineering representative for assistance.

Interpreting the Site Survey Results

Site Survey results are listed as a percentage of data packets received and indicate the signal strength of the received signal.

Site survey results

	Result	Description
	Green	Packets received at a strong signal strength. A strong signal strength is greater than -90 dBm at the receiver.
	Yellow	Packets received at a good signal strength. A good signal is between -90 and -100 dBm at the receiver.
	Red	Packets received at a weak signal strength. A weak signal is less than -100 dBm at the receiver.
	Missed	Packets not received on the first transmission and requiring a retry.

Judging if the reliability of a network's signal meets the needs of the application is not just a matter of green, yellow, and red packets received. In normal operating mode, when data packets are not received, the transmitter re-sends the packet until all data is received.

For slow monitoring applications such as a tank farm, where data is required in terms of seconds or minutes, receiving most of the data in the 'red' range, indicating a weak but reliable signal, transmits enough data for accurate monitoring. Nodes positioned near the outside range of the radio signal may have 90% of the data packets received in the red zone, again indicating a weak, but reliable signal.

Improving Your Site Survey Results

Refer to the Sure Cross Installation Guide (p/n [151514](#)) for installation details and tips and tricks for improving your radio network's performance.

If your Site Survey results have more yellow than green, consider replacing the Node's antenna with one the following:

- Use a 2 dBi Omni dome antenna (model BWA-9O2-D) or a 5 dBi Omni antenna (model BWA-9O5-C)
- Use a 6 dBi Yagi (directional) antenna (model BWA-9Y6-A)

If the distance between devices is greater than 5,000 meters (3 miles) line-of-sight or objects, such as trees or man-made obstructions, interfere with the path, and the MISSED packet count exceeds 25 per 100 packets, consider the following steps:

- Install the antenna(s) remotely at a higher position (requires an antenna extension cable);
- Use a higher gain antenna;
- Decrease the distance between devices; or
- Use data radios to extend the position of the Gateway relative to the host system.

Performance Levels

Referenced omni-directional and directional antennas are listed at the end of this section.

Very strong signal strength is 100 green signals (displayed on the LCD) or eight flashes per second (models without LCDs). If the included 2 dBi OMNI antenna does not achieve this signal strength, use a different omni antenna, such as the 2 dBi dome antenna (same gain, different form factor) or 5 dBi antenna (higher gain). You may also use a low-gain directional antenna, such as the 6.5 dBd Yagi antenna.

Strong signal strength is represented by some green signals and some yellow signals (very few red signals and very few missed signals) or four flashes per second. To improve your radio performance, consider using a different omni antenna, such as the 2 dBi dome antenna, 5 dBi antenna, 6 dBi antenna, or 8 dBi antenna. You may also use a low-gain directional antenna, such as the 6.5 dBd Yagi antenna. We also recommend installing the antenna(s) remotely at a higher position. Additional antenna cables are available from Banner Engineering if needed.

Good or weak signal strength equals some yellow signals and a majority of red signals (very few green signals, a small number of yellow signals, and a small to medium number of missed signals) or one to two flashes per second. To improve your radio performance, consider using one of the 6 dBi or 8 dBi omni-directional antennas or the 10 dBd directional antenna. We also recommend installing the antenna(s) remotely at a higher position. Additional antenna cables are available from Banner Engineering if needed.

No radio communication is when more than 50% of the radio signals are missed or a solid amber LED. To improve radio performance, use a 8 dBi omni-direction antenna or a 10 dBd directional antenna and elevate the antenna above any obstructions. The lack of signals may also be due to the distance between the Gateway (master radio) and Nodes (remote radio). If this is the case, please contact Banner Engineering for further assistance. We also recommend installing the antenna(s) remotely at a higher position. Additional antenna cables are available from Banner Engineering if needed.

Omni-Directional (Omni) Antennas

BWA-9O2-D (2 dBi OMNI antenna, dome style)—For applications where a durable antenna is needed external to the radio enclosure.

BWA-9O5-C (5 dBi OMNI antenna with RP-SMA connector)—Antenna for medium antenna performance increase or to elevate the antenna above obstacles such as buildings or tall crops. We recommend using one of the following LMR200 extension cables (RP-SMA to RP-SMA):

- BWC-2MRSFRS3 (3 meters long)
- BWC-2MRSFRS6 (6 meters long)
- BWC-2MRSFRS9 (9 meters long)
- BWC-2MRSFRS12 (12 meters long)

BWA-9O6-AS (6 dBi OMNI antenna with Type N cable connector)—Antenna for strong antenna performance increase. Requires a RP-SMA to Type N converter cable (BWC-1MRSMN05). May require one of the following antenna extension cables:

- BWC-4MNFN3 (3 meters long)
- BWC-4MNFN6 (6 meters long)
- BWC-4MNFN15 (15 meters long)
- BWC-4MNFN30 (30 meters long)

Requires a surge suppression device (model BWC-PRC827-DC) if the antenna is external to a building, connected to other electronics, or elevated.

BWA-908-AS (8 dBi OMNI antenna with Type N cable connector)—Antenna for very strong antenna performance increase. Requires a RP-SMA to Type N converter cable (model BWC-1MRSMN05). May require one of the following antenna extension cables:

- BWC-4MNFN3 (3 meters long)
- BWC-4MNFN6 (6 meters long)
- BWC-4MNFN15 (15 meters long)
- BWC-4MNFN30 (30 meters long)

Requires a surge suppression device (model BWC-PRC827-DC) if the antenna is external to a building, connected to other electronics, or elevated.

Directional (Yagi) Antennas

BWA-9Y6-A (6.5 dBd YAGI antenna with Type N cable connector)—Antenna for strong, directional antenna performance. Requires a RP-SMA to Type N converter cable (model BWC-1MRSMN05). May require one of the following antenna extension cables:

- BWC-4MNFN3 (3 meters long)
- BWC-4MNFN6 (6 meters long)
- BWC-4MNFN15 (15 meters long)
- BWC-4MNFN30 (30 meters long)

Requires a surge suppression device (model BWC-PRC827-DC) if the antenna is external to a building, connected to other electronics, or elevated.

BWA-9Y10-A (10 dBd YAGI antenna with Type N cable connector)—Antenna for very strong, directional antenna performance increase. Requires a RP-SMA to Type N converter cable (model BWC-1MRSMN05). May requires one of the following antenna extension cables:

- BWC-4MNFN3 (3 meters long)
- BWC-4MNFN6 (6 meters long)
- BWC-4MNFN15 (15 meters long)
- BWC-4MNFN30 (30 meters long)

Requires a surge suppression device (model BWC-PRC827-DC) if the antenna is external to a building, connected to other electronics, or elevated.

Document title: Conducting a Site Survey and Interpreting the Results

Part number: 133602

Revision: G

© Banner Engineering Corp. All rights reserved.

Chapter Contents

Mounting Sure Cross Devices Outdoors	23
Other Installation Requirements	24
Installation Quick Tips	24
Installing a Basic Remote Antenna.....	26

Chapter 4 Installing Your Sure Cross® Radios

Follow these recommendations to install your wireless network components.

Mounting Sure Cross Devices Outdoors

Use a Secondary Enclosure. For most outdoor applications, we recommend installing your Sure Cross devices inside a secondary enclosure. For a list of available enclosures, refer to the Accessories List (p/n [b_3147091](#)).

Point Away From Direct Sunlight—When you are not using a secondary enclosure, minimize the damaging effects of ultra-violet radiation by mounting the devices to avoid facing intense direct sunlight.

- Mount under an overhang or other source of shade,
- Install indoors, or
- Face the devices north when installing outside.

Point the radio away from direct sunlight

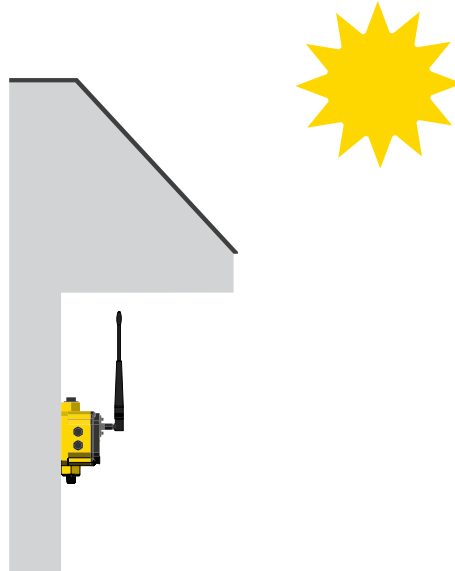

For harsh outdoor applications, consider installing your radio inside a secondary enclosure.

Mount Vertically to Avoid Collecting Rain—When possible, mount the devices where rain or snow will drain away from the device.

- Mount vertically so that precipitation, dust, and dirt do not accumulate on permeable surfaces.
- Avoid mounting the devices on flat or concave surfaces, especially if the display will be pointing up.

Remove Moisture and Condensation—If condensation is present in any device, add a small desiccant packet to the inside of the radio. To help vent the radios, Banner also sells a vented plug (model number **BWA-HW-031**) for the 1/2-inch NPT port of the Sure Cross radios.

Watertight Glands and NPT Ports

To make glands and plugs watertight, use PTFE tape and follow these steps.

1. Wrap four to eight passes of polytetrafluoroethylene (PTFE) tape around the threads as close as possible to the hexagonal body of the gland.

2. Manually thread the gland into the housing hole. Never apply more than 5 in-lbf of torque to the gland or its cable clamp nut. ⁽¹⁾

Watertight glands wrapped in PTFE tape



Seal any unused access holes with one of the supplied plastic plugs. To install a watertight plug:

1. Wrap four to eight passes of PTFE tape around the plug's threads, as close as possible to the flanged surface.
2. Carefully thread the plastic plug into the vacant hole in the housing and tighten using a slotting screwdriver. Never apply more than 10 in-lbf torque to the plastic plug.

If your device has an unused NPT port, install a watertight NPT plug:

1. Wrap 12 to 16 passes of PTFE tape evenly across the length of the threads.
2. Manually thread the plug into the housing port until reaching some resistance.
3. Using a crescent wrench, turn the plug until all the plug's threads are engaged by the housing port or until the resistance doubles. Do not over-tighten as this will damage the device. These threads are tapered and will create a waterproof seal without over-tightening.

Other Installation Requirements

Reduce Chemical Exposure—Before installing any devices in a chemically harsh environment, contact the manufacturer for more information regarding the life-expectancy. Solvents, oxidizing agents, and other chemicals will damage the devices.

Minimize Mechanical Stress—Although these radio devices are very durable, they are sophisticated electronic devices that are sensitive to shock and excessive loading.

- Avoid mounting the devices to an object that may be shifting or vibrating excessively. High levels of static force or acceleration may damage the housing or electronic components.
- Do not subject the devices to external loads. Do not step on them or use them as handgrips.
- Do not allow long lengths of cable to hang from the glands on the Gateway or Node. Cabling heavier than 100 grams should be supported instead of allowed to hang from the housing.
- Do not crack the housing by over-tightening the top screws. Do not exceed the maximum torque of 4 in-lbf.

It is the user's responsibility to install these devices so they will not be subject to over-voltage transients. Always ground the devices in accordance with local, state, or national regulations.

When Installing 1-Watt Radios—Notice: This equipment must be professionally installed. The output power must be limited, through the use of firmware or a hardware attenuator, when using high-gain antennas such that the +36 dBm EIRP limit is not exceeded.

Installation Quick Tips

The following are some quick tips for improving the installation of wireless network components.

Create a Clear Communication Path

Wireless communication is hindered by radio interference and obstructions in the path between the transmitter and receiver. To achieve the best radio performance, carefully consider the installation locations for the Gateways and Nodes and select locations without obstructions in the path.

For more information about antennas, please refer to the *Antenna Basics* reference guide, Banner document p/n 132113.

Increase the Height of the Antennas

Position the external antenna vertically for optimal radio communication. If necessary, consider changing the height of the Sure Cross radio, or its antenna, to improve reception. For outdoor applications, mounting the antenna on top of a building or pole may help achieve a line-of-sight radio link with the other radios in the network.

⁽¹⁾ This is equivalent to the torque generated without using tools. If a wrench is used, apply only very light pressure. Torquing these fittings excessively damages the device.

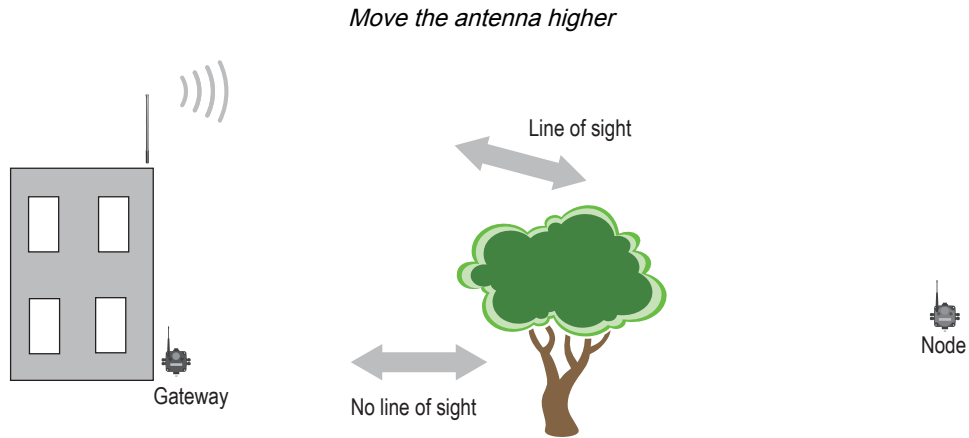

Collocated Radios

When the radio network's master device is located too close to another radio device, communications between all devices is interrupted. For this reason, always assign a unique Network ID to your wireless networks.

The Network ID (NID) is a unique identifier you assign to each wireless network to minimize the chances of two collocated networks interfering with each other. Assigning different NIDs to different networks improves collocation performance in dense installations.

Do not install antennas within the minimum separation distance.

Antenna Minimum Separation Distance

900 MHz (transmitting at 150 mW and 250 mW): 2 m (6 ft) with the supplied 2 dB antenna

900 MHz (transmitting at 1 Watt): 4.57 m (15 ft) with the supplied 2 dB antenna

2.4 GHz: 0.3 m (1 ft) with the supplied 2 dB antenna

Be Aware of Seasonal Changes

When conducting the initial Site Survey, the fewest possible missed packets for a given link is better. However, seasonal changes may affect the signal strength and the total signal quality. Radios installed outside with 50% missed packets in the winter months may have 80% or more missed packets in the summer when leaves and trees interfere with radio reception.

A good signal in winter doesn't always mean you will get the same signal strength the rest of the year.

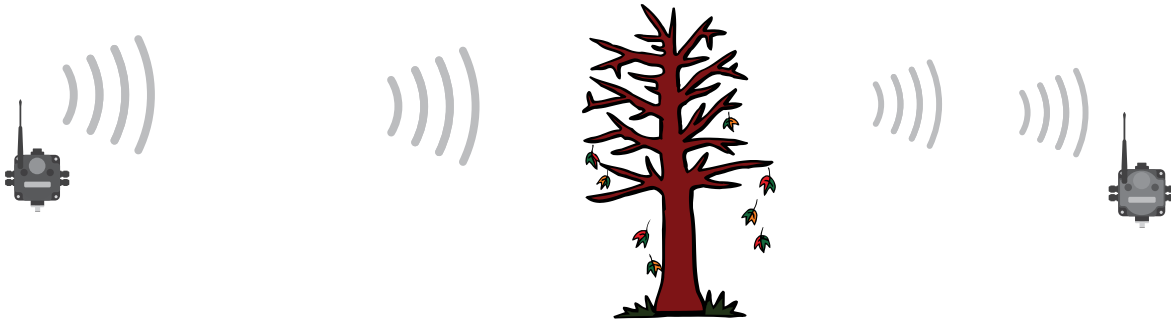

During spring and summer, leaves may block more of the radio signal.

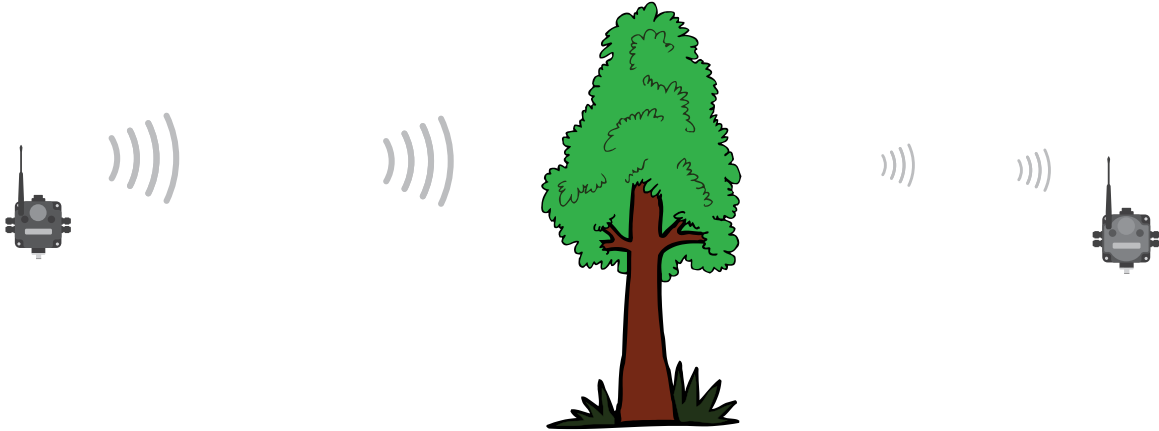

Installing a Basic Remote Antenna

A remote antenna system is any antenna system where the antenna is not connected directly to the radio; coaxial cable connects the antenna to the radio.

When installing a remote antenna system, always include a lightning arrestor or coaxial surge suppressor in the system. Remote antenna systems installed without surge protection invalidate the warranty of the radio devices.

Surge suppressors should be properly grounded and mounted at ground level near where the cabling enters a building. Install the surge suppressor indoors or inside a weatherproof enclosure to minimize corrosion or component deterioration. For best results, mount the surge suppressor as close to the ground as possible to minimize the length of the ground connection and use a single-point ground system to avoid creating ground loops.

For more detailed information about how antennas work and how to install them, refer to Antenna Basics (p/n [132113](#)).

Basic remote antenna components

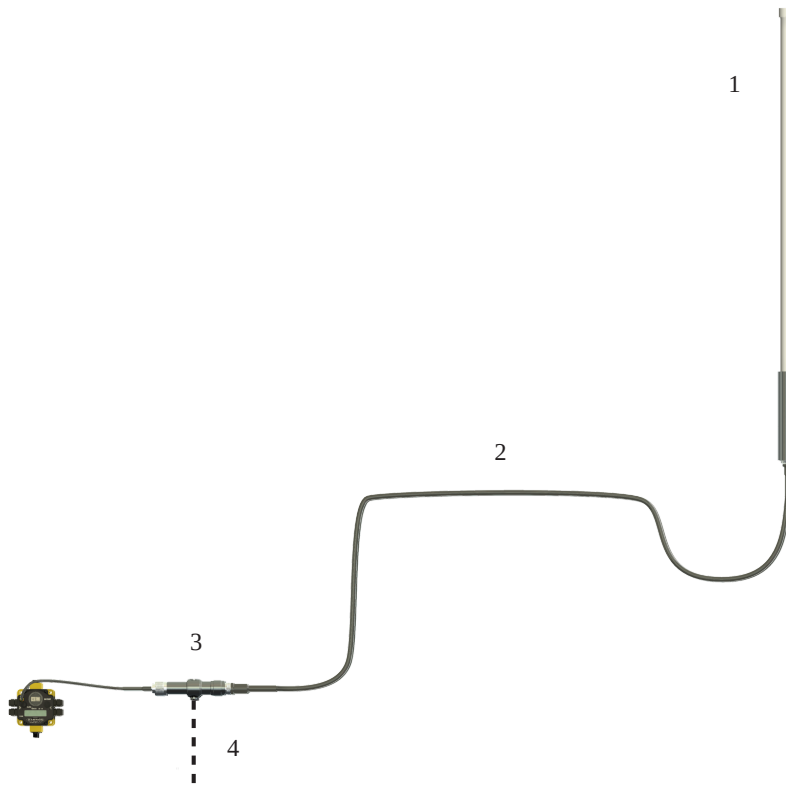

1. Antenna mounted remotely from the radio device.
2. Coaxial cable
3. Surge suppressor
4. Ground wire to a single-point ground system

I/O Isolation—When connecting analog and discrete I/O to external equipment such as VFDs (Variable Frequency Drives), it may be appropriate to install interposing relays and/or loop isolation devices to protect the DX80 unit from transients, noise, and ground plane interference originating from devices or the environment. Contact Banner Engineering Corp. for more information.

Weatherproof Remote Antenna Installations

Seal the connections with rubber splicing tape and electrical tape to prevent water damage to the cable and connections.

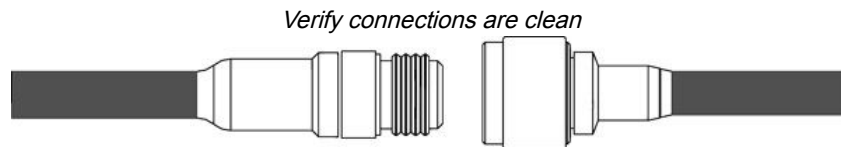

Step 1: Verify both connections are clean and dry before connecting the antenna cable to the antenna or other cable. Hand-tighten the cable connections.

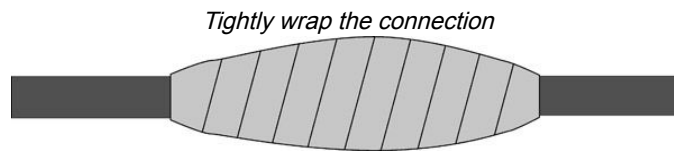

Step 2: Tightly wrap the entire connection with rubber splicing tape. Begin wrapping the rubber splicing tape one inch away from the connection and continue wrapping until you are one inch past the other end of the connection. Each new round of tape should overlap about half the previous round.

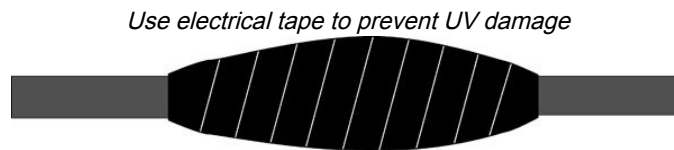

Step 3: Protect the rubber splicing tape from UV damage by tightly wrapping electrical tape on top of the rubber splicing tape. The electrical tape should completely cover the rubber splicing tape and overlap the rubber tape by one inch on each side of the connection.

Installing Remote Antennas

Install and properly ground a qualified surge suppressor when installing a remote antenna system. Remote antenna configurations installed without surge suppressors invalidate the manufacturer's warranty. Keep the ground wire as short as possible and make all ground connections to a single-point ground system to ensure no ground loops are created. No surge suppressor can absorb all lightning strikes; do not touch the Sure Cross® device or any equipment connected to the Sure Cross® device during a thunderstorm.

Mount a Dome Antenna to the Enclosure

Use a -D dome antenna when mounting an antenna directly to the outside of the enclosure.

Components to mount a dome antenna to an enclosure

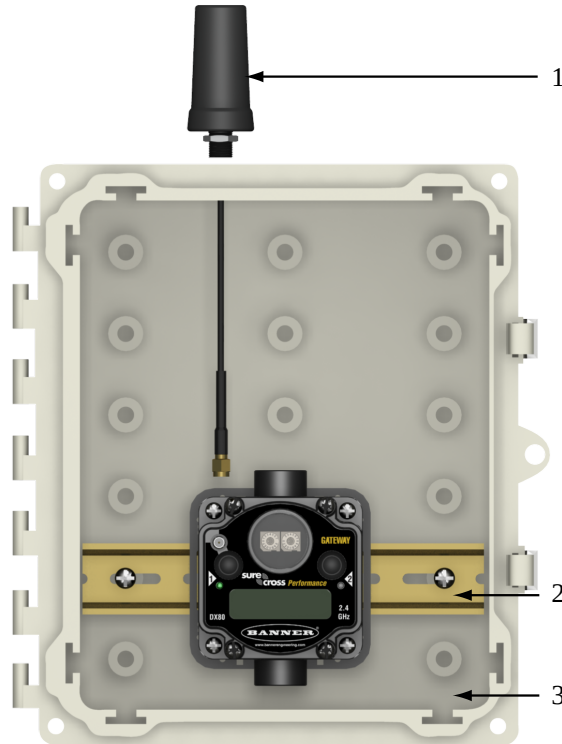

1. Dome antenna
2. DIN rail and DIN rail bracket
3. Enclosure

The -D dome antennas come with an 18-inch RP-SMA extension cable connected to the antenna. Use this extension cable to connect the antenna directly to the radio.

To mount, drill a hole in the enclosure and insert the antenna.

Omni-directional dome antenna with RP-SMA male connection

Model	Description	
BWA-902-D	Dome antenna, 2 dBi, 18-inch cable, 900 MHz, RP-SMA Box Mount Datasheet: b_3145121	
BWA-202-D	Dome antenna, 2 dBi, 18-inch cable, 2.4 GHz RP-SMA Box Mount Datasheet: b_3145115	

Use an N-Type, Pole-Mounted Antenna

This antenna mounts remotely from the box, with the Sure Cross® device mounted inside the box.

Ground the surge suppressor and antenna. Keep the ground wire as short as possible and make all ground connections to a single-point ground system to ensure no ground loops are created.

Components to mount an antenna on a pole

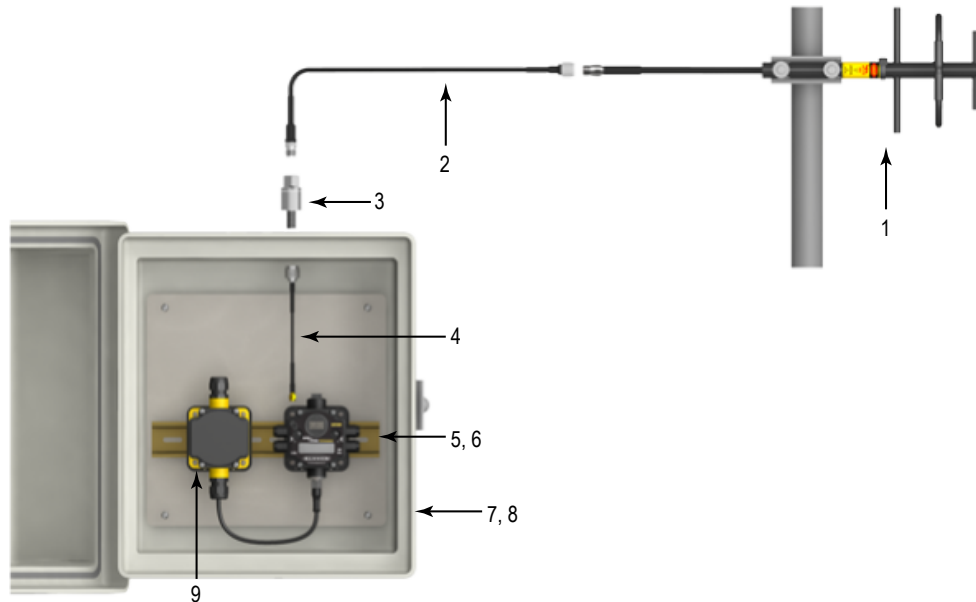

1. N-type Yagi antenna
2. N-Type to N-Type antenna cable
3. Surge suppressor
4. RP-SMA to N-Type male antenna cable
- 5 and 6. DIN rail and DIN rail bracket
- 7 and 8. Enclosure and enclosure cover/plate, etc
9. Power supply

Directional (Yagi) antennas with an N-type female connection

Model	Description	
BWA-9Y6-A	6.5 dBd, 6.8 × 13 inches Outdoor, 900 MHz Datasheet: b_3145127	
BWA-9Y10-A	10 dBd, 6.8 × 24 inches Outdoor, 900 MHz Datasheet: b_3145130	

Omni-directional fiberglass antennas with N-type female connections

Model	Description	
BWA-906-A	6 dBd, Fiberglass, Full wave, 71.5 inches, 900 MHz Datasheet: b_3145124	
BWA-208-A	8.5 dBi, Fiberglass, 24 inches, 2.4 GHz Datasheet: b_3145131	
BWA-206-A	6 dBi, Fiberglass, 16 inches (shown), 2.4 GHz Datasheet: b_3145117	
BWA-906-AS	6 dBi, Fiberglass, 1/4 Wave, 23.6 inches (1.3-inch dia.), 900 MHz Datasheet: b_3145125	
BWA-908-AS	8 dBi, Fiberglass, 3/4 Wave, 63 inches (1.5-inch dia.), 900 MHz Datasheet: b_3145126	

Use the LMR400 cables to connect the surge suppressor to the antenna.

N-type to N-type cables—LMR400 type

Model	Length (m)	Description	
BWC-4MNFN3	3	LMR400 N-Type Male to N-Type Female	
BWC-4MNFN6	6		
BWC-4MNFN15	15		
BWC-4MNFN30	30		

Surge suppressors

Model	Description	
BWC-LMRSFRPB	Surge Suppressor, Bulkhead, RP-SMA Type, RP-SMA to RP-SMA	
BWC-PRC827-DC	Surge Suppressor, bulkhead, DC Blocking, N-Type Female, N-Type Male	

Use the RP-SMA to N-Type male cables to connect the radio to the surge suppressor.

RP-SMA to N-type cables—LMR200 type

Model	Length (m)	Description	
BWC-1MRSMN05	0.5	LMR200 RP-SMA to N-Type Male	
BWC-1MRSMN2	2		

Chapter Contents

DX80 Menu Structure	31
Binding Mode: What does it do?	38
Setting the Network ID in Extended Addressing Mode	40
Manually Assign a Binding Code to a Gateway	40
Manually Assign a Binding Code to a Node	41
Setting the Maximum System Devices	42
Storage and Sleep Modes	42
Modbus Holding Registers	42
Modbus Communication Parameters	43
Default Output Conditions	44
Defining the Units	46

Chapter 5 Advanced Setup Options

Refer to the following sections for advanced setup instructions or additional information on Banner's Sure Cross® wireless technology and its uses.

DX80 Menu Structure

The Gateways and Nodes each have their own menu structure and options.

When power is applied, the DX80 begins running. The display screen auto loops through the **RUN** menu and communication begins between the Gateway and Node(s). Auto looping through the **RUN** menu is the normal operating mode for all devices on the wireless network.

From the **RUN** Menu (or any menu), single-click button 1 to advance through the top-level menus. The device auto display loops through the menu options if either of the **RUN**, **DINFO**, or **FCTRY** menus are selected. If the device is paused on the **SITE** (Gateway only), **DVCFG**, or **DERR** menu options, the display does not auto loop.

To enter manual scrolling mode, double-click button 2 at the top level menu. Use the instructions shown in the chart below to navigate the menu system. To return to the top level menus and auto display loop mode, double-click button 2 twice.

Node LCD Timeout: After 15 minutes of inactivity, the LCD screen stops displaying information. Press any button to refresh the display if the Node has entered this energy-saving mode.

The * before the menu name indicates a top-level menu option. The () indicate submenu items.

When using Rotary Dial Addressing Mode:

- Gateway—Use the left rotary dial to set the Network ID (NID).
- Nodes—Use the rotary dials to set the Network ID (NID) and Device ID (NADR) at any time. The left rotary dial sets the Network ID and the right rotary dial sets the Node Address.

After any rotary dial is changed, allow five seconds for the devices to update to the new Network ID.

Gateway menu system

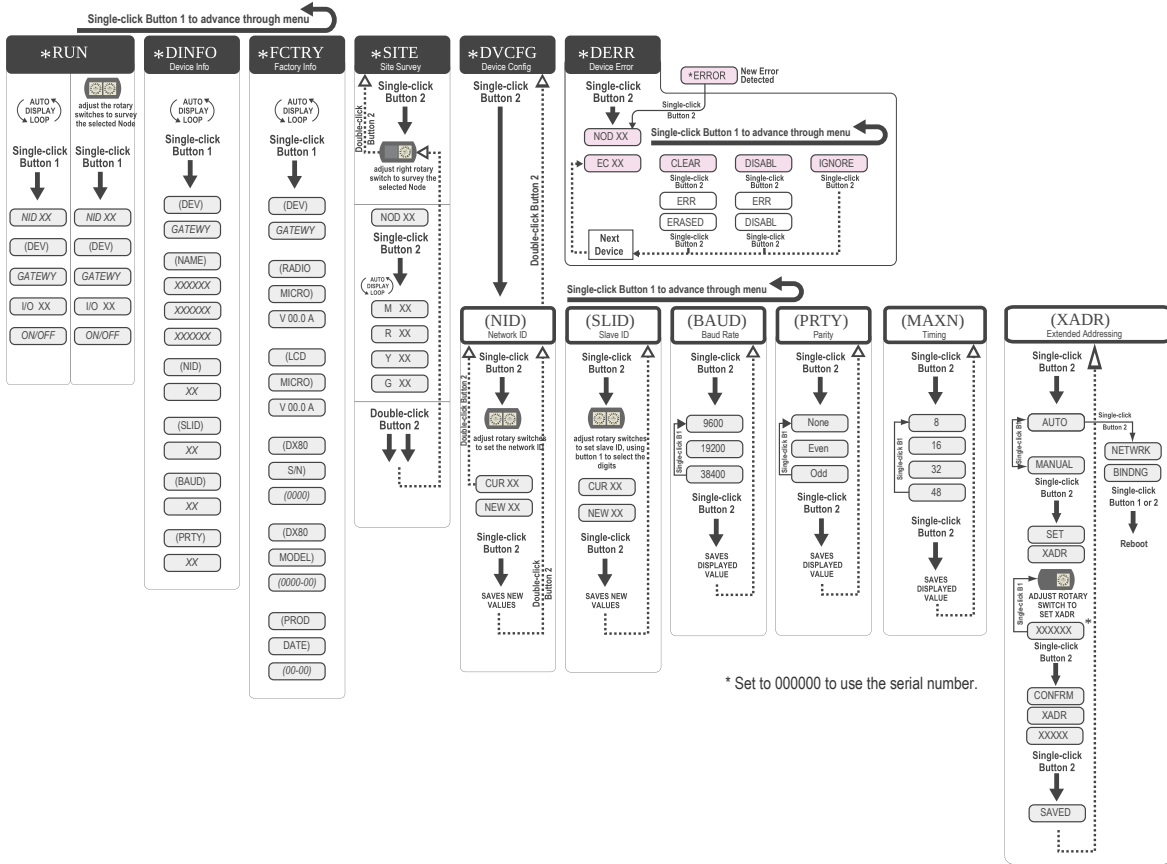

* Set to 000000 to use the serial number.

Node menu system

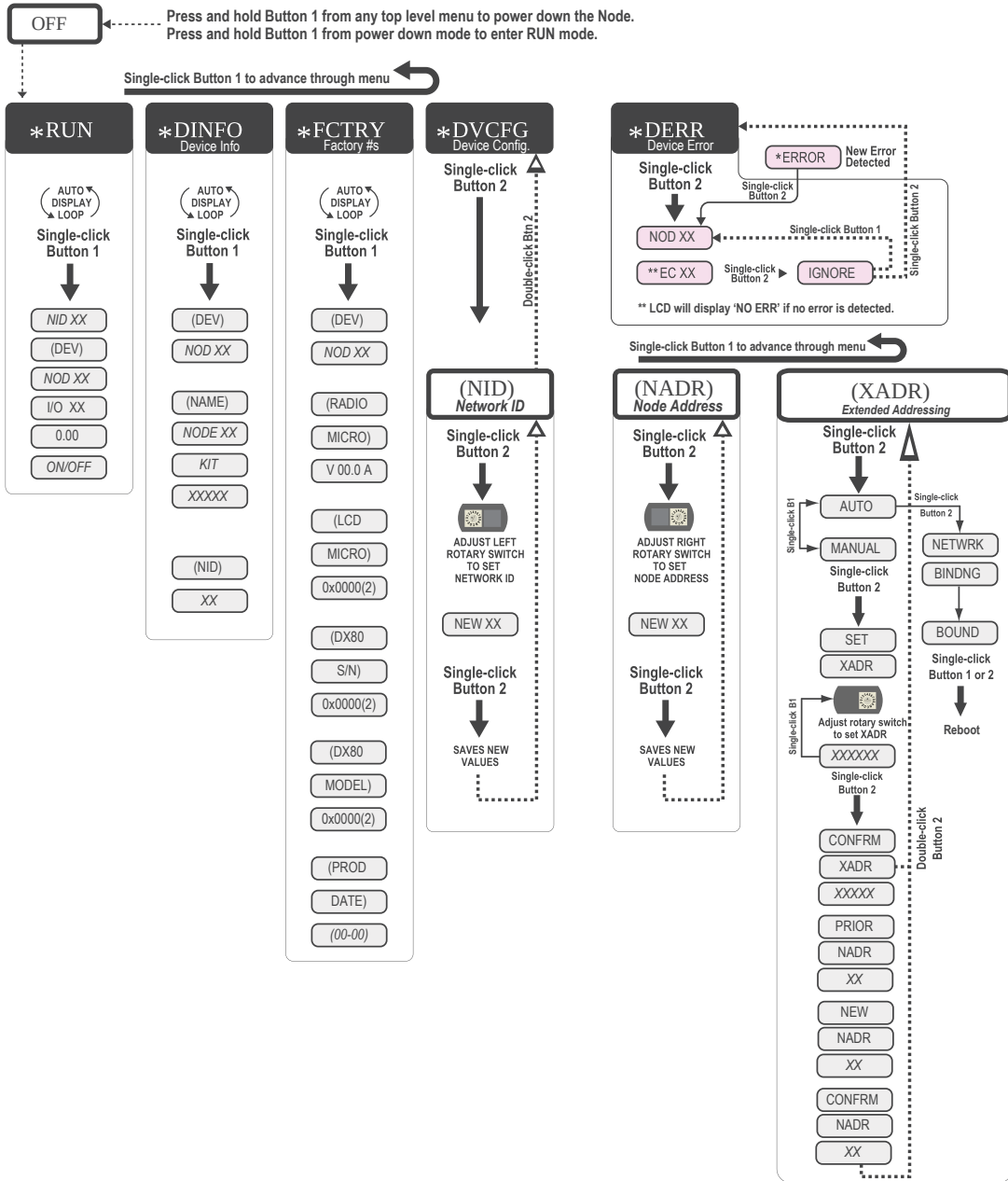

RUN Menu

The **RUN** menu displays the network ID (NID), device name (Gateway or Node), and the I/O values of the device.

RUN menu on the Gateway and Node

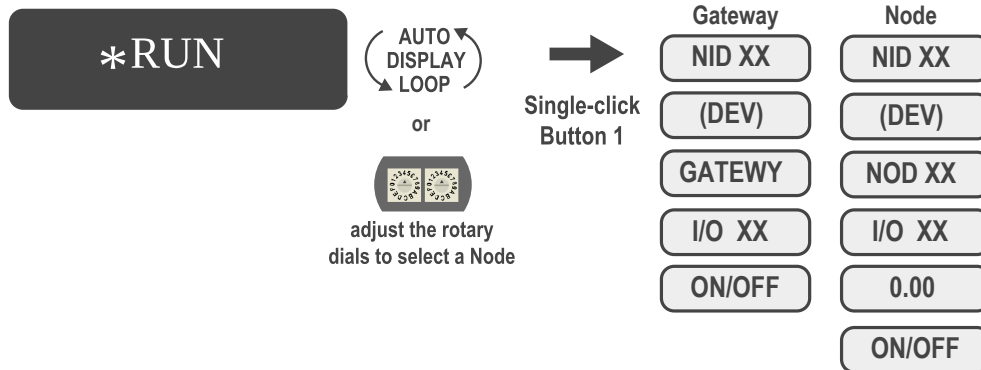

On the Gateway, the I/O displayed may be the I/O of the Gateway or of a selected Node. To view the I/O of a specific Node, set the position of the rotary dials to the Node's address. For example, to view the I/O of Node 12, set the Gateway's left rotary dial to 1 and the right rotary dial to 2.

When using extended address mode, the network ID (NID) is not used. The Network ID is typically used only in rotary dial address mode.

DINFO (Device Information) Menu

The **DINFO** menu displays some device-specific information.

DINFO menu for the Gateway and Node

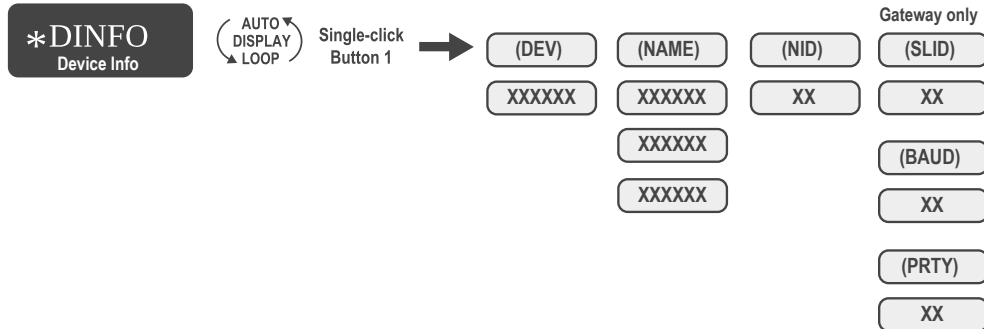

On the Gateway, the **DINFO** menu displays the device name, the network ID (NID), slave ID, baud rate, and parity. When in extended address mode, the **DINFO** menu also displays the maximum Node setting and the extended addressing (**XADR**), or binding, code used to form the network.

On the Node, the **DINFO** menu displays the device type including the Node address, the device name, and the network ID (NID).

When using extended address (binding) mode, the network ID value is no longer used by the devices. This number is not the extended address (binding) code.

FCTRY (Factory) Menu

The **FCTRY** menu displays the version numbers of various components within the device, including the radio micro number, the LCD number, the device's serial number, the device's model number, and the production date.

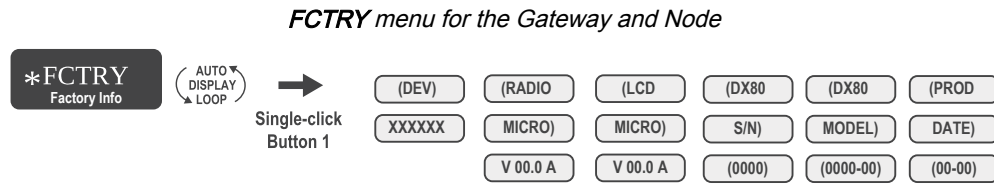

If you call Banner Engineering for technical support, having this information available may help diagnose your particular problem.

SITE (Site Survey) Menu

The **SITE** menu displays the results of a Site Survey conducted with this Gateway.

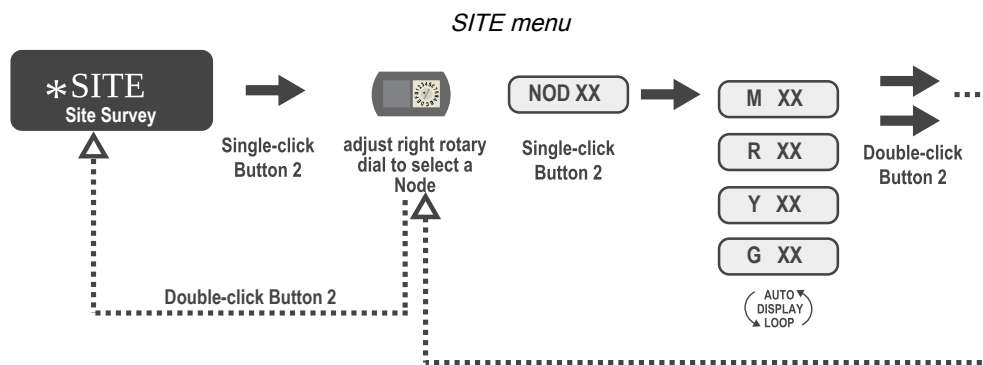

The **SITE** menu displays the device number of the Node the Site Survey was conducted with as well as the missed, green, yellow, and red received packet count. The **SITE** menu is only available on the Gateways. To access the **SITE** menu, single-click button 1 to scroll across the menu levels until reaching the Site Survey (**SITE**) menu.

See ["Conduct a Site Survey Using the Menu System"](#) on page 17.

See ["Interpreting the Site Survey Results"](#) on page 20.

DVCFG (Device Configuration) Menu

On Gateways, the **DVCFG** menu allows users to set various device-specific parameters, including the network ID (**NID**), slave ID (**SLID**), baud rate, and parity. In extended address mode, use this menu to also set the maximum number of radio devices (**MAXN**) within the network and the extended address binding code (**XADR**).

DVCFG menu of the Gateway

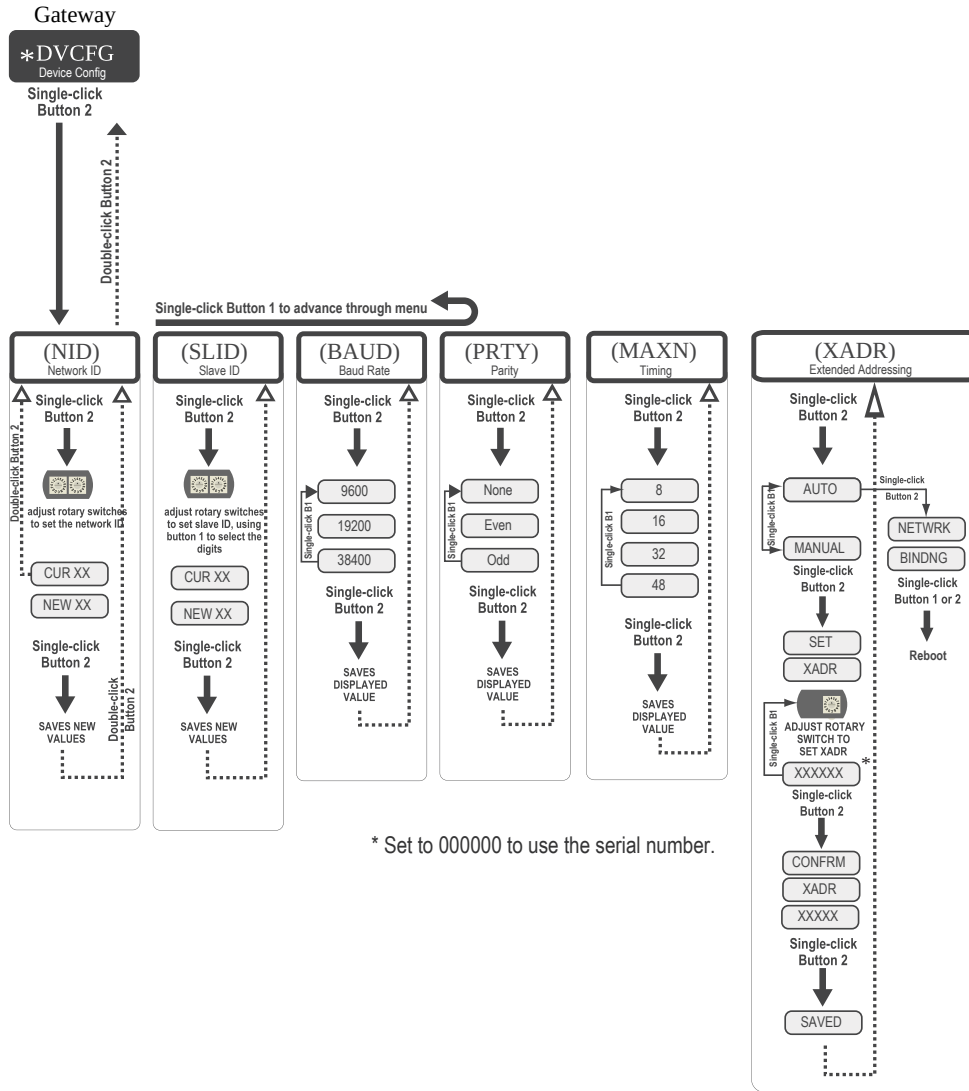

Baud and Parity

The options for baud rate are: 19200, 38400, or 9600. For parity, select None, Even, or Odd.

Extended Address (Binding) Code

Binding Nodes to a Gateway ensures the Nodes only exchange data with the Gateway they are bound to. After a Gateway enters binding mode, the Gateway automatically generates and transmits a unique extended addressing (XADR), or binding, code to all Nodes within range that are also in binding mode. The extended addressing (binding) code defines the network, and all radios within a network must use the same code.

Max Nodes

Selecting the maximum number of system radio devices (Gateway and all Nodes) changes the timing for the wireless network. For example, if you are running four Nodes in your wireless network, set the system's maximum device count to 8. This allows up to 8 radio devices, including the Gateway, in the wireless network and offers the highest throughput, 62.5 milliseconds, for each Node. The choices are 8, 16, 32, and 48 devices.

Network ID

The Network ID (NID) is a unique identifier you assign to each wireless network to minimize the chances of two collocated networks interfering with each other. Assigning different NIDs to different networks improves collocation performance in dense installations.

Slave ID

The Modbus ID is an identifying number used for devices within a Modbus system. When using more than one Modbus peripheral, assign each peripheral device a unique ID number.

On Nodes, use the **DVCFG** to set the network ID (**NID**) and extended address binding code (**XADR**). The Node address (**NADR**), also referred to as a Node ID or device address, is only functional on some models.

DVCFG menu of the Node

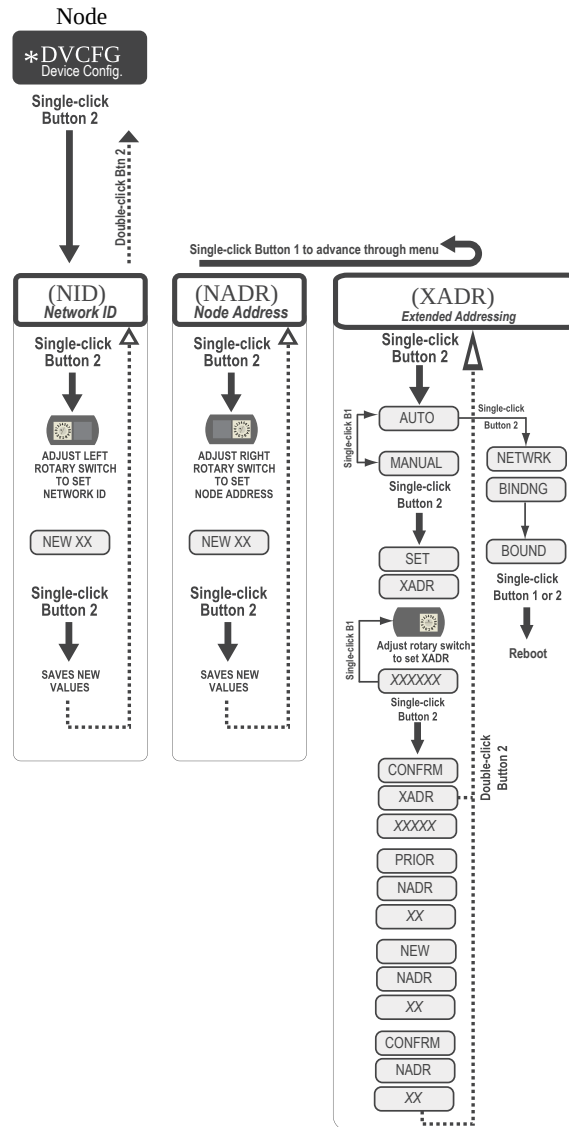

DERR (Device Error) Menu

Use the **DERR** menu to manage device error messages.

DERR menu for the Gateway and Node

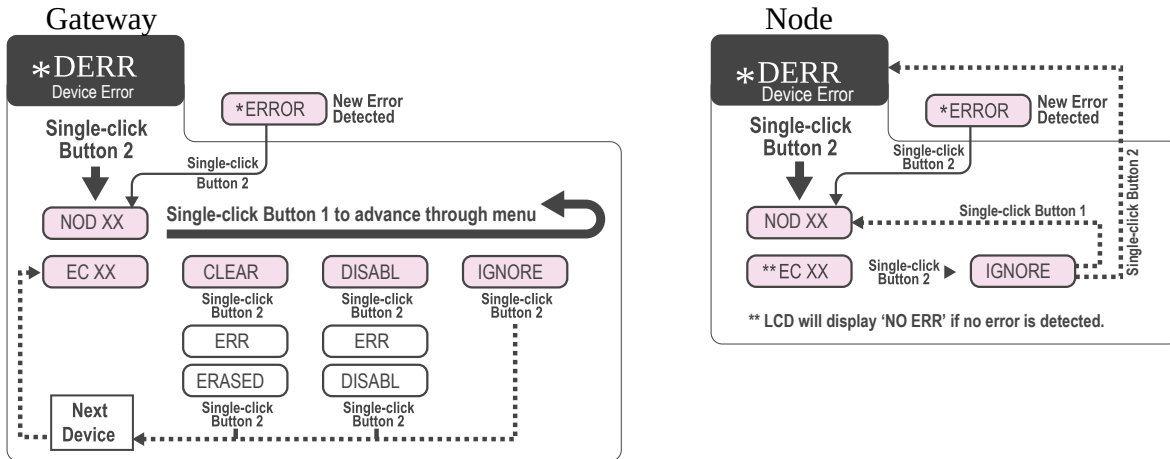

On the Gateway use the **DERR** menu to clear, disable, or ignore error messages generated by devices within the network. The Node number that generated the error and the error code (EC) display onscreen. Single-click button 1 to advance through the menu of **CLEAR** (clear this particular instance of the error from the system), **DISABL** (disable this particular error from appearing from this specific Node), and **IGNORE** (ignore this error but do not remove it from the system). After the error messages for a Node are cleared, disabled, or ignored, errors for any additional Nodes display on the Gateway's LCD.

On the Node use the **DERR** menu to view and ignore error messages for that Node.

Binding Mode: What does it do?

Binding Nodes to a Gateway ensures the Nodes only exchange data with the Gateway they are bound to. After a Gateway enters binding mode, the Gateway automatically generates and transmits a unique extended addressing (XADR), or binding, code to all Nodes within range that are also in binding mode. The extended addressing (binding) code defines the network, and all radios within a network must use the same code.

After binding your Nodes to the Gateway, make note of the binding code displayed under the ***DVCFG > XADR** menu on the Gateway's LCD. Knowing the binding code prevents having to re-bind all Nodes if the Gateway is ever replaced.

Automatic Binding Using the Menu Navigation

The easiest way to bind the Gateway to its Nodes is by triple clicking button 2 to enter automatic binding mode. If you would prefer to begin automatic binding mode using the menu structure instead of the buttons, follow these steps.

Before making any changes to the DIP switches, disconnect the power to the devices. For devices with batteries integrated into the housing, remove the battery.

- On the Gateway:** remove the top cover.
- Move DIP switch 1 to the ON position.
Extended Addressing Mode is activated using DIP switch 1.
- Apply power to the Gateway.
The Gateway's LCD displays POWER, then *RUN.
- On the Gateway, single click button 1 to advance across the menus, stopping at the DVCFG menu.
The Gateway's LCD displays (DVCFG).
- Single click button 2 to select DVCFG. Single click button 1 to select from the available menu options, stopping at XADR.
The Gateway's LCD displays (XADR).
- Single click button 2 to enter XADR mode. When the display reads (AUTO), single click button 2 again to begin the automatic binding mode.
The LEDs flash alternately when the Gateway is in binding mode. Any Node entering binding mode will bind to this Gateway. The Gateway's LCD displays NETWORK BINDING.
- On the Node:** remove the top cover.

8. Move DIP switch 1 to the ON position.
Extended address mode is activated using DIP switch 1.
9. Apply power to the Node.
The Node's LCD displays POWER, then *RUN.
10. On the Node, single click button 1 to advance across the menus, stopping at the DVCFG menu.
The Node's LCD displays (DVCFG).
11. Single click button 2 to enter the DVCFG menu.
12. Single click button 1 to select from the available submenu options, stopping at XADR.
The Node's LCD displays (XADR).
13. Single click button 2 to enter the XADR submenu.
14. When the display reads (AUTO), single click button 2 to begin the automatic binding mode.
The Node enters binding mode. The Node's LCD displays NETWRK BINDNG. When the Node is bound, the LEDs are both solid red for a few seconds. The Node cycles its power, then enters RUN mode.
15. Use both of the Node's rotary dials to assign a decimal Node address between 01 and 47.

The left rotary dial represents the tens digit (0–4) and the right dial represents the ones digit (0–9) of the device address.

16. Repeat steps 7 through 15 for each additional Node that needs to communicate to that Gateway.
17. **On the Gateway:** single click button 1 or button 2.
When button 1 or 2 is pressed, the Gateway exits binding mode and reboots. The Gateway's LCD displays POWER, then *RUN.

For devices with batteries integrated into the housing, remove the battery for one minute to cycle power to the device. After making any changes to DIP switch settings, you must cycle power to the device or the DIP switch changes will not be recognized.

Bind Radios Using Modbus Commands

Use Modbus commands to bind Nodes to a Gateway when the Node does not have rotary dials.

Apply power to the Gateway and Nodes.

1. Write 0x01*NN* (hex) to the Gateway's register 6371; where *NN* is the Node's ID number in hex.

Write to register 6371 to start binding mode

Value to write to register 6371		Action
Decimal	Hex	
256	0x0100	The Gateway enters binding mode and does not assign a Node ID (used with Nodes that get their ID from the rotary dials).
256	0x0101	The Gateway enters binding mode and assigns the Node that enters binding mode to ID 1
261	0x0105	The Gateway enters binding mode and assigns the Node that enters binding mode to ID 5
291	0x0123	The Gateway enters binding mode and assigns the Node that enters binding mode to ID 35

The LEDs flash alternately when the Gateway is in binding mode.

2. Enter binding mode on the Node.
 - If you have a two-button Node, triple-click button 2.
 - If you have a one-button Node, triple-click the button.
 - If you have a Node with no buttons, remove the top cover and set both the left and right rotary dials to F to enter binding mode.

The Node enters binding mode and locates the Gateway in binding mode.

For two LED Nodes, the red LEDs flash alternately. After binding is complete, both LEDs are both solid red for a few seconds.

For one-LED Nodes, the red and green LED flashes alternately while the Node searches for the Gateway. After binding is complete, the LED is red and green for four seconds (looks amber), then the red and green flash simultaneously (looks amber) four times.

The Node automatically exits binding mode, cycles its power, then enters RUN mode, using the Node ID the binding process just assigned to it.

3. Repeat steps 1 and 2 for all Nodes that will communicate to this Gateway.
4. Write 0x0000 (hex) to the Gateway's register 6371 to stop the binding procedure.

For more information about using Modbus commands, refer to Host Controller Systems instruction manual (p/n [132114](#)).

Setting the Network ID in Extended Addressing Mode

Use the menu system to set the Network ID when using extended address mode.

1. From the top level menus, single click button 1 to advance through the menus, stopping at **DVCFG** (Device Configuration).
The Gateway's LCD displays **DVCFG**.
2. Single-click button 2 to enter the **DVCFG** menu options and stop at **(NID)**.
The Gateway's LCD displays **(NID)**.
3. Single-click button 2.
Enters the **(NID)** menu option.
4. Using both rotary dials on the Gateway, select a Network ID. The left rotary dial acts as the left digit and the right rotary dial acts as the right digit of the Network ID. In extended addressing mode, the Network ID can only be set from the rotary dials while in the **(NID)** menu.

Any Nodes bound to this Gateway 'follow' the Gateway to the new Network ID automatically. The current Network ID and the new Network ID display on the LCD panel.

5. Single-click button 2.
Saves the new values.
6. Double-click button 2.
Exits this submenu and the LCD displays **(NID)**.
7. Double-click button 2.
Exits to the main menu system and returns to **RUN** mode. The LCD displays **DVCFG**.

Manually Assign a Binding Code to a Gateway

Manually assign the binding code (**XADR**) when replacing components of an existing wireless network.

To determine the existing binding code, access the **DINFO** (Device Information) menu of either the existing Gateway or another Node in the network. Follow the submenu structure to the **XADR** display for that device.

1. Apply power to the Gateway.
The Gateway's LCD shows **POWER**, then **RUN**.
2. On the Gateway, single click button 1 to advance across the menus, stopping at the **DVCFG** menu.
The Gateway's LCD shows **(DVCFG)**.
3. Single click button 2 to select **DVCFG**. Single click button 1 to select from the available menu options, stopping at **XADR**.
4. Single click button 2 to enter the **XADR** menu.
AUTO is automatic binding mode and uses the Gateway's serial number as the binding code.
5. Single click button 1 to select manual mode.
6. Single click button 2 to enter manual mode.
MANUAL allows the user to manually enter an binding code.
7. Single click button 2 to advance to the binding code entry step.

After entering manual mode, use the right rotary dial to select the digits of the binding code. The LCD shows **SET XADR 000000**.

8. Use the right rotary switch to begin setting the binding code. Digit selection begins with the left most digit. After selecting the first digit, single click button 1 to advance right to the next digit. All six digits must be filled, even if it is with leading zeros. For example, to use 2245 as the code, enter 002245 into the device.
To use the Gateway's serial number, enter 000000 as the binding code.
9. Continue entering the code using a single click of button 1 to advance from left to right.
After reaching the sixth digit, the curser returns to the first digit.
10. Single click button 2 when code entry is complete.
The Gateway LCD displays the entered value for confirmation by showing **CONFRM XADR**, then repeating back your value.
11. Single click button 2 to save the code and exit the **XADR** menu.

When entering the binding code, the digits auto fill with whatever position the rotary switch is currently in. For example, after entering the 00 part of the binding code 002245, the third digit auto fills with a 0 until the rotary dial is rotated to 2.

After manually changing the binding code on a Gateway in an existing network, change the binding code for all Nodes in that network by either manually setting the code on all Node(s) or by beginning the automatic binding sequence on the Gateway and auto-binding all the Node(s).

Manually Assign a Binding Code to a Node

Manually assign the binding code when replacing components of an existing wireless network.

To determine the existing binding code, access the **DINFO** (Device Information) menu of either the existing Gateway or another Node in the network. Follow the submenu structure to the **XADR** display for that device.

1. Apply power to the Node.⁽¹⁾
The LCD displays **POWER**, then **RUN**.
2. On the Node, single click button 1 to advance across the menus, stopping at the **DVCFG** menu.
3. Single click button 2 to select **DVCFG**. Single click button 1 to select from the available menu options, stopping at **XADR**.
4. Single click button 2 to enter the **XADR** menu.
AUTO is automatic binding mode and uses the Gateway's serial number as the binding code.
5. Single click button 1, stopping at manual mode.
MANUAL allows the user to manually enter a binding code.
6. Single click button 2 to enter manual mode.
7. Single click button 2 to enter the binding code entry step.
The LCD shows **SET XADR 000000**.
8. Use the right rotary switch to begin setting the binding code. Digit selection begins with the left most digit. After selecting the first digit, single click button 1 to advance right to the next digit. All six digits must be filled, even if it is with leading zeros. For example, to use 2245 as the code, enter 002245 into the device.
9. Continue entering the code using a single click of button 1 to advance from left to right.
After reaching the sixth digit, the curser returns to the first digit.
10. Single click button 2 when code entry is complete. The Node LCD displays the entered value for confirmation.
The LCD shows **CONFRM XADR XXXXXX**.
11. If the rotary dial hasn't been returned to the previous Node address (device address or ID), the LCD displays the prior setting as a reminder. Return the rotary dial to its previous Node address.
12. The new Node address setting displays (**NEW NADR XX**).
13. The Node confirms the new Node address by displaying **CONFRM NADR XX**.
14. Double click button 2 to exit the **XADR** menu and to return to **RUN** mode.

When entering the binding code, the digits autofill with whatever position the rotary switch is currently in. For example, after entering the 00 part of the binding code 002245, the third digit autofills with a 0 until the rotary dial is rotated to 2.

⁽¹⁾ For devices with batteries integrated into the housing, remove the battery for one minute to cycle power to the device.

Setting the Maximum System Devices

To set the maximum number of devices in your system, use the **MAXN** submenu, located under the **DVCFG** (Device Configuration) menu.

Selecting the maximum number of system radio devices (Gateway and all Nodes) changes the timing for the wireless network. For example, if you are running four Nodes in your wireless network, set the system's maximum device count to 8. This allows up to 8 radio devices, including the Gateway, in the wireless network and offers the highest throughput, 62.5 milliseconds, for each Node. The choices are 8, 16, 32, and 48 devices.

Storage and Sleep Modes

Storage Mode (applies to battery-powered models only)—While in **storage mode**, the radio does not operate. To put any integrated battery Sure Cross® radio into storage mode, press and hold button 1 for five seconds. To wake the device, press and hold button 1 for five seconds. The radio is in storage mode when the LEDs stop blinking, but in some models, the LCD remains on for an additional minute after the radio enters storage mode. After a device has entered storage mode, you must wait one minute before waking it.

Sleep Mode (applies to both battery and 10–30 V DC powered models)—During normal operation, the Sure Cross radio devices enter **sleep mode** after 15 minutes of operation. The radio continues to function, but the LCD goes blank. To wake the device, press any button.

Modbus Holding Registers

There are sixteen Modbus holding registers for each device. Calculate the holding register number for each device using the equation: Register number = I/O# + (Node# × 16).

The Gateway is always device 0 and the Gateway's holding registers are registers 1 through 16. Registers for Node 1 are 17 through 32. Although only seven Nodes are listed, the registers continue for as many Nodes as are in the network. For example, the register number for Node 10, I/O point 15, is 175.

Modbus holding registers

I/O Point	Gateway	Node 1	Node 2	Node 3	Node 4	Node 5	Node 6	Node 7
1	1	17	33	49	65	81	97	113
2	2	18	34	50	66	82	98	114
3	3	19	35	51	67	83	99	115
4	4	20	36	52	68	84	100	116
5	5	21	37	53	69	85	101	117
6	6	22	38	54	70	86	102	118
7	7	23	39	55	71	87	103	119
8	8	24	40	56	72	88	104	120
9	9	25	41	57	73	89	105	121
10	10	26	42	58	74	90	106	122
11	11	27	43	59	75	91	107	123
12	12	28	44	60	76	92	108	124
13	13	29	45	61	77	93	109	125
14	14	30	46	62	78	94	110	126
15	15	31	47	63	79	95	111	127
16	16	32	48	64	80	96	112	128

Modbus Communication Parameters

To access the Modbus device, you may first need to configure system-level communication parameters on the Gateway.

The following procedures are necessary to change the Gateway's slave ID, baud rate, and parity. Setting up the Network and Device IDs, powering up the devices, and conducting the Site Survey for a host-connected network is the same as for the non-host DX80 or DX80 Performance wireless system. All device I/O for the network is accessed using the host/master device.

Modbus communication parameters

Parameter	Default Value	Description
Slave ID	1	Defines the slave number (01–99) for the serial Modbus RTU protocol. When operating more than one network with a Modbus Master device, change the Slave IDs.
Baud Rate	19200	Defines communication data rate (19.2, 38.4, or 9.6 kbps) between the Gateway and the Host through the serial interface.
Parity	None	Defines serial parity (none, even, or odd) between Gateway and Host.

Set the Slave ID on a DX80 Gateway

By default, all Gateways are set to Modbus Slave ID 1.

To change the Slave ID on the Gateway, follow these steps.

1. Single-click button 1 to advance between menus. Stop when you reach the **DVCFG** menu.
2. Press button 2 once at the **DVCFG** menu to enter the Device Configuration menu.
3. Press button 1 to advance through the items in the **DVCFG** menu. Stop advancing when you've reached the setting for the slave ID (**SLID**).
The screen is displaying (**SLID**).
4. Press button 2 once to enter the slave ID (**SLID**) submenu.
The screen displays the current slave ID number.
5. Press button 1 to advance across the three-digit slave ID while using the right rotary dial to select the number. To make a change, rotate the right rotary dial to zero, then to the desired number.
As you press button 1 to select the digit, the digit changes to reflect the position of the right rotary dial. To set the slave ID to 3, the display should read 003.
6. Press button 2 once to save your current setting.
The display reads **SAVED**.
7. Double-click button 2 to exit the **DVCFG** menu.
8. If using a Network ID (**NID**), adjust both rotary switches back to the NID value.
To avoid losing the network connection between the Gateway and Nodes, reset the rotary switches back to their appropriate values before leaving the **DVCFG** sub-menus. If the Gateway and Nodes lose their connection, the network may take up to 20 seconds to re-synchronize.
9. Double-click Gateway button 2 to return to the Device Configuration (**DVCFG**) menu.
10. Click Gateway button 1 until reaching the **RUN** menu option.

Set the Baud Rate

The baud rate establishes the communication rate between the Gateway and the host system to which it is wired.

1. Single-click button 1 to advance between menus. Stop when you reach the **DVCFG** menu.
2. Press button 2 once at the **DVCFG** menu to enter the Device Configuration menu.
3. Press button 1 to advance through the items in the **DVCFG** menu. Stop advancing when you've reached the setting for the **BAUD** rate.
4. Single-click Gateway button 2 to display the current setting. Single-click Gateway button 1 to cycle through the available options. Stop on the desired setting.
The options are 9600, 19200, 38400. The factory default is 19200.
5. Single-click Gateway button 2 to save the new setting.
6. If using a network ID (NID), adjust both rotary switches back to the NID value.
To avoid losing the network connection between the Gateway and Nodes, reset the rotary switches back to their appropriate values before leaving the **DVCFG** sub-menus. If the Gateway and Nodes lose their connection, the network may take up to 20 seconds to re-synchronize.

7. Double-click Gateway button 2 to return to the Device Configuration (**DVCFG**) menu.
8. Click Gateway button 1 until reaching the **RUN** menu option.

Set the Parity

Parity bits are used to detect errors in data.

1. Single-click button 1 to advance between menus. Stop when you reach the **DVCFG** menu.
2. Press button 2 once at the **DVCFG** menu to enter the Device Configuration menu.
3. Press button 1 to advance through the items in the **DVCFG** menu. Stop advancing when you've reached the setting for the **PARITY**.
4. Single-click Gateway push button 2 to display the current setting. Single-click Gateway push button 1 to cycle through the available options. Stop on the desired setting.

The options are NONE, EVEN, ODD. The factory default is NONE.

5. Single-click Gateway button 2 to save the new setting.
6. If using a network ID (**NID**), adjust both rotary switches back to the **NID** value.
To avoid losing the network connection between the Gateway and Nodes, reset the rotary switches back to their appropriate values before leaving the **DVCFG** sub-menus. If the Gateway and Nodes lose their connection, the network may take up to 20 seconds to re-synchronize.
7. Double-click Gateway button 2 to return to the Device Configuration (**DVCFG**) menu.
8. Click Gateway button 1 until reaching the **RUN** menu option.

Default Output Conditions

The timeout structure of the Sure Cross wireless network sets relevant outputs to user-defined conditions when radio or host communications fail.

If the timeout features are enabled, the outputs are set to default states or the last known state before the error. The timeout error conditions are cleared by either a reset command sent from the host, using the front panel display, or using the auto-recover feature. Communications timeouts occur in three areas within the Sure Cross wireless system:

- Host Link Failure to the Gateway (Modbus Timeout)
- Gateway Link Failure with any Node
- Node Link Failure with the Gateway

Host Link Failure

A **Host Link Failure** occurs when the defined timeout period, typically about four seconds, elapses with no communication between the host system and the DX80 Gateway.

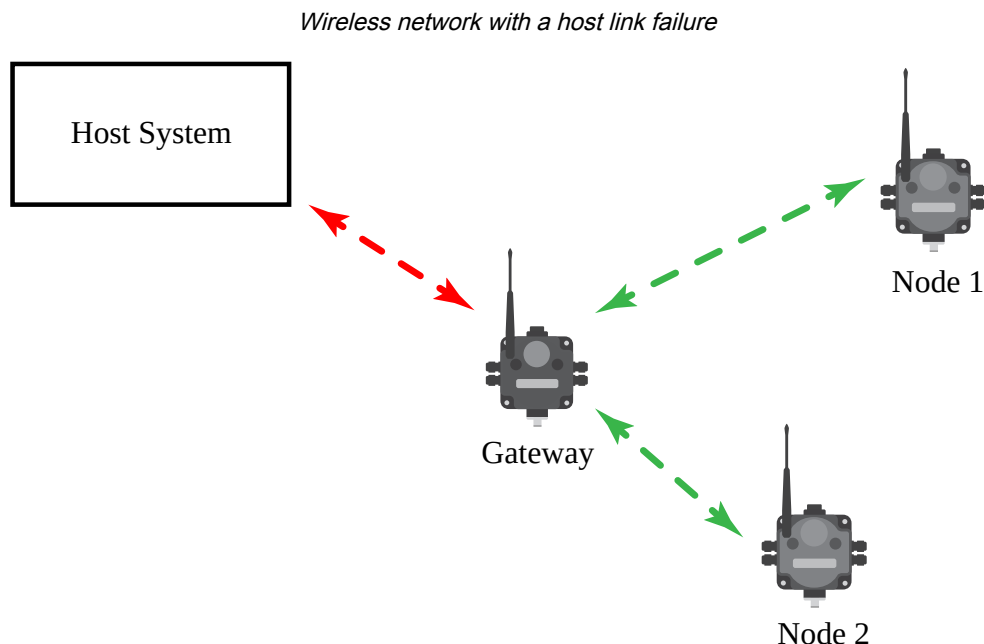

The Gateway places an error code in its I/O 8 register and sends a message to all relevant Nodes within the system to set outputs to the user-defined default states. Each Node has an enable flag for a host link failure condition. If a Node's 'host link failure' flag is not set, the outputs on the Node are not affected.

In the example shown, a host link failure between the host system and Gateway result in the outputs of Node 1 and Node 2 sent to the defined conditions if both Nodes have the host link failure enabled. When the host link failure is enabled, you should disable the automatic recovery. The host system should restart the system after the error condition is corrected.

Gateway Link Failure

Gateway link failures are determined by three global parameters: polling interval, maximum missed message count, and re-link count.

The **polling interval** (or rate) defines how often the Gateway communicates with each Node to verify the radio link is operating. The Gateway increments a Node's missed message count if a Node does not immediately report back from a polling request. If a Node's missed message count exceeds the **maximum missed message count**, the Gateway generates a timeout error in the Modbus I/O 8 register of the appropriate Node.

The auto-recover feature uses the **re-link count** parameter. If enabled, the error condition heals itself if the Gateway and Node have successfully exchanged N-number of good polling messages. The N-number is the re-link count, or the number of messages required to re-establish a radio link.

When the Node's **Gateway Link Failure** flag is set and the Gateway determines a timeout condition exists for a Node, any outputs linked from the failing Node are set to the user-defined default state. Each Node has a Gateway Link Failure flag that can be set or cleared depending on the particular application.

Wireless network with a communication failure between a Gateway and Node

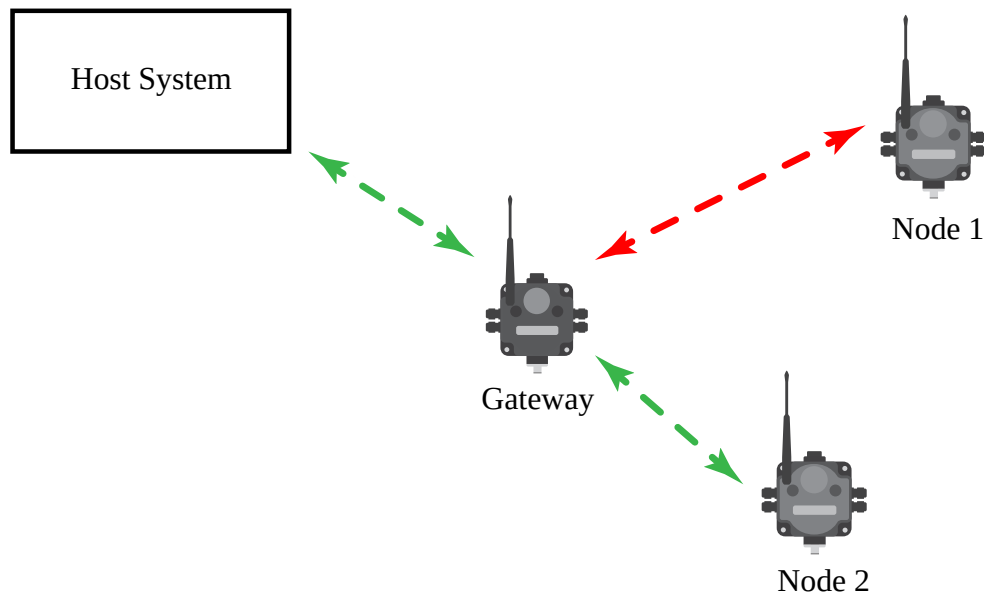

In the sample system shown, the communication link between the Gateway and Node 1 has failed. Node 2 must have its Gateway Link Failure flag set to allow any outputs linked to Node 1 to be set to the defined default state when the communication link between Node 1 and the Gateway fails.

Node Link Failure

A Node Link Failure is determined by the polling interval/rate or the out-of-sync timing.

When a Node detects a communications failure with the Gateway and the Node Link Failure flag is set, the output points are set to the user-defined states and the inputs are frozen. When output points are set to their default states because of an error condition, only the Gateway can clear the error condition and resume normal operation. The front panel buttons or the Gateway's register I/O 15 clear error conditions.

Clearing a lost radio link error does not restore communications. Banner recommends determining and resolving the cause of the radio link error, then allowing the system to auto-recover the lost communications.

Polling Interval. The global polling interval defines the time interval during which the Node should expect a polling request from the Gateway.

Out of Sync. An out of sync condition is met when a Node fails to receive the Gateway's beacon within a factory-set time period, about 10 seconds. Both the out of sync and polling interval conditions are used to detect a failure because the Node can remain in sync with the Gateway but be unable to transmit data. If the Gateway drops out of the network, the Nodes detects the out of sync condition long before the polling interval expires.

Defining the Units

The units parameter defines the range and/or type of data value associated with an input or output.

Selecting **Units** from within any configuration tool changes the units definition of several parameters, including threshold, hysteresis, and delta. For example, if the units are 0 to 20 mA, the threshold, hysteresis, and delta values are entered as milliampere values. Selecting Temp °C changes the threshold, hysteresis, and delta units to degrees Celsius.

Signed values range from -32768 to +32767 and allow for the measurement of negative values. Signed values are typically used for measuring temperatures. Signed values are stored as two's complement values.

Unsigned values range from 0 to 65535 and are used to measure values that do not go below zero, such as 4 to 20 mA, distance, or a counter.

Input Units

Defining the input units

Units	Description	Definition	LCD
0	Raw	Displays the raw A/D conversion data with data ranges from 0 to 65535. This units type is typically used only for factory calibration.	Raw A/D hex value
1	4 to 20 mA	Analog unit. Modbus register contents are scaled such that 0 represents 4 mA and 65535 represents 20 mA.	4.00mA–20.00mA
2	0 to 20 mA	Default analog input unit. Modbus register contents are scaled such that 0 represents 0 mA and 65535 represents 20 mA.	0.00mA–20.00mA
3	Discrete (ON/OFF)	Default discrete input unit.	ON/OFF
4	0 to 10 V (Volts)	Analog input using 0 to 10 V instead of current. Modbus register contents are scaled such that 0 represents 0V and 65535 represents 10V.	0.00V–10.00V
6	Temp °C	Celsius, high resolution. Analog input for temperature devices such as thermocouples, RTD, and thermistors. In high resolution mode, temperature = (Modbus register value) ÷ 20.	0000.0C
7	Temp °F	Fahrenheit, high resolution. Analog input for temperature devices such as thermocouples, RTD, and thermistors. In high resolution mode, temperature = (Modbus register value) ÷ 20.	0000.0F
8	Temp °C (Low Res)	Celsius, low resolution. To measure a greater temperature range, use the low resolution unit. In low resolution mode, temperature = (Modbus register value) ÷ 2.	0000.0C
9	Temp °F (Low Res)	Fahrenheit, low resolution. To measure a greater temperature range, use the low resolution unit. In low resolution mode, temperature = (Modbus register value) ÷ 2.	0000.0F
10	Asynchronous Counter, 32-bit	The 32-bit counter value records counts up to 4.29 billion.	0000 0000
11	Asynchronous Counter, 16-bit	The 16-bit counter value records counts up to 65535.	0000

Output Units

Defining the output units

Units	Description	Definition	LCD
0	Raw	Displays the raw A/D conversion data with data ranges from 0 to 65535. This units type is typically used only for factory calibration.	Raw A/D hex value
1	4 to 20 mA	Analog unit. Modbus register contents are scaled such that 0 represents 4 mA and 65535 represents 20 mA.	4.00mA–20.00mA

Continued on page 47

Continued from page 46

Units	Description	Definition	LCD
2	0 to 20 mA	Default analog input unit. Modbus register contents are scaled such that 0 represents 0 mA and 65535 represents 20 mA.	0.00mA–20.00mA
3	Discrete (ON/OFF)	Default discrete unit.	ON/OFF
4	0 to 10 V (Volts)	Analog unit using 0 to 10 V instead of current. Modbus register contents are scaled such that 0 represents 0 V and 65535 represents 10 V.	0.00V–10.00V
5	Signed Analog, 0 to 10 V	For a signed value, such as temperature, that is to be converted to a voltage out value. Use null to set the start point and span to define the range. The null value is the starting temperature to be associated with 0 V. The span is the entire temperature range that is to be associated with 0 to 10 V.	0.00V–10.00V
6	Signed Analog, 0 to 20 mA	For a signed value, such as temperature, that is to be converted to a mA out value. Use null to set the start point and span to define the range. The null value is the starting temperature to be associated with 0 mA. The span is the entire temperature range that is to be associated with 0 to 20 mA.	0.00mA–20.00mA
7	Unsigned Analog, 0 to 20 mA	For unsigned values, such as a counter, that is to be converted to a mA out value. Use the null to set the start point and span to define the range. The null value is the distance to be associated with 0 mA. The span is the entire distance range that is to be associated with 0 to 20 mA.	0.00mA–20.00mA
8	Signed Analog, 4 to 20 mA (A)	In older models, this units type is for degree Celsius conversions only. Use null to set the start point and span to define the range. The null value is the starting temperature to be associated with 4 mA. The span is the entire temperature range that is to be associated with 4 to 20 mA. For newer firmware models, type codes 8 and 9 are treated the same.	4.00mA–20.00mA
9	Signed Analog, 4 to 20 mA (B)	In older models, this units type is for degree Fahrenheit conversions only. Use null to set the start point and span to define the range. The null value is the starting temperature to be associated with 4 mA. The span is the entire temperature range that is to be associated with 4 to 20 mA. For newer firmware models, type codes 8 and 9 are treated the same.	4.00mA–20.00mA
10	Unsigned Analog, 0 to 10 V	For an unsigned value, such as 0 to 20 mA, that is to be converted to a voltage out value. Use the null to set the start point and span to define the range. The null value is the distance to be associated with 0V. The span is the entire distance range that is to be associated with 0 to 10 V.	0.00V–10.00V
11	Counter, 16-bit	The 16-bit counter value records counts up to 65535.	0000
12	Unsigned Analog, 4 to 20 mA	For an unsigned value, such as 0 to 10 V, that is to be converted to a mA out value. Use the null to set the start point and span to define the range. The null value is the distance to be associated with 4 mA. The span is the entire distance range that is to be associated with 4 to 20 mA.	4.00mA–20.00mA

Interpreting Register Values in the Banner Wireless System

The units conversion table defines the type and range of values for each type of I/O.

The wireless devices have many different units of measure for inputs including: milliamp (mA), voltage (V), temperature (°C or °F), humidity (RH), or a raw 16-bit or 32-bit value. Outputs can be either current (4 to 20 mA, 0 to 20 mA) or voltage (0 to 10 V DC). All values stored in Modbus registers are unsigned numbers, except for temperature readings. The temperature readings are stored as signed numbers (two's complement).

The following table defines the range of values and descriptions for input units.

Register values

Input Type	I/O Range		Holding Register Representation		Data Conversion	Description
	Min.	Max.	Min.	Max.		
Discrete	0	1	0	1	-	-
0 to 20 mA	0.0 mA	20.0 mA	0	65535	$(20 \text{ mA} \div 65535) \times \text{Reg Value} = \text{mA}$	Linear mapping of unsigned register value to current
4 to 20 mA	4.0 mA	20.0 mA	0	65535	$((16 \text{ mA} \div 65535) \times \text{Reg Value}) + 4 = \text{mA}$	Linear mapping of unsigned register value to current
0 to 10 V dc	0.0 V DC	10.0 V DC	0	65535	$(10 \text{ V} \div 65535) \times \text{Reg Value} = \text{V}$	Linear mapping of unsigned register value to voltage
Temp C/F (high resolution)	-1638.3	+1638.4	0	65535	$(\text{Converted Reg Value}) \div 20 = \text{Temp}$	Signed Values
Counter	0	65535	0	65535	-	-
16-bit T30UF	0 mm	65535 mm	0	65535	None; stored as millimeter value	Unsigned

Continued on page 48

Continued from page 47

Input Type	I/O Range		Holding Register Representation		Data Conversion	Description
	Min.	Max.	Min.	Max.		
Humidity	0% RH	100% RH	0	10000	(Reg Value) ÷ 100 = Relative Humidity (RH)	Unsigned

Temperature Measurements:

- In high resolution mode, the temperature = (Modbus register value) ÷ 20. For high resolution temperature input, 0 in the register is interpreted as 0° and 65535 in the register (0xFFFF) is interpreted as $-1 \div 20 = -0.05^\circ$.
- In low resolution mode, the temperature is (Modbus register value) ÷ 2. For low resolution temperature input, 0 in the register is interpreted as 0° and 65535 in the register (0xFFFF) is interpreted as $-1 \div 2 = -0.5^\circ$. The I/O range values are -16383 through 16384.

When using a 4 to 20 mA sensor with a 0 to 20 mA input, the sensor uses the 4 to 20 mA section of the total range. Using a 4 to 20 mA with a 0 to 20 mA input allows you to determine when you have an error condition with the sensor. A normal input reading between 4 and 20 mA indicates a functioning sensor whereas a value below 4 mA indicates an error condition, such as a broken wire or loose connection. Some Sure Cross devices allow you to configure the analog inputs and outputs to use either 0 to 20 mA or 4 to 20 mA.

Signed Numbers

Temperature values are stored in Modbus registers as two's complement signed numbers. Using two's complement allows negative numbers to be stored in Modbus registers.

Although not technically a sign bit, the most significant bit (MSB) indicates a negative number when the value is set to one (1). When the most significant bit is zero (0), the value is greater than or equal to zero.

Modbus register values of 32768 through 65535 (decimal) represent negative temperatures. These numbers in binary form are: 1000 0000 0000 0000 through 1111 1111 1111 1111.

To convert to a negative temperature value from a Modbus register value, first convert the value from the two's complement number. To convert from a two's complement number in binary form, invert all the bits (0 changes to 1, 1 changes to a 0), then add 1. Convert this binary value to a decimal value and divide by either 20 (high-resolution mode) or 2 (low-resolution mode) to calculate the negative temperature.

Defining the signed numbers

Register Value (Two's Complement)	Register Value (Decimal)	Converted Decimal	Calculated Temperature (Converted Decimal ÷ 20)
0000 0000 0000 0101	5	5	0.25
0000 0000 0000 0100	4	4	0.20
0000 0000 0000 0011	3	3	0.15
0000 0000 0000 0010	2	2	0.10
0000 0000 0000 0001	1	1	0.05
0000 0000 0000 0000	0	0	0
1111 1111 1111 1111	65535	-1	-0.05
1111 1111 1111 1110	65534	-2	-0.10
1111 1111 1111 1101	65533	-3	-0.15
1111 1111 1111 1100	65532	-4	-0.20
1111 1111 1111 1011	65531	-5	-0.25
1111 1100 0001 1000	64536	-1000	-50

Mapping Unit Types

Using signed or unsigned value types allows the user to generically map any input to any output. The signed and unsigned values read the null and span parameters to create the linear translation between one scale and another. The output type is set to mA or V.

$$\text{Output} = (\text{Fullscale}/\text{Span})(\text{InputValue} - \text{Null}) + \text{Offset}$$

Defining the mapping unit types

Output Scale	Fullscale (range)	Offset
0 to 20 mA	20 mA	0 mA
4 to 20 mA	16 mA	4 mA
0 to 10 V	10 V	0 V

Fullscale

Defined in the table; the output range.

Input Value

The value mapped to the output.

Null

The starting point for the output scale.

Offset

Defined in the table; the starting output value.

Span

The total range of values mapped to the output.

Example: Mapping a Temperature

Map a temperature input from a Node to a 4 to 20 mA output. The starting temperature is -20°F and the last temperature will be 50°F ($4\text{ mA} = -20^{\circ}\text{F}$, $20\text{ mA} = 50^{\circ}\text{F}$). This defines the null as -20°F and the span as 70.

With an input temperature value of -5°F , the output value will be:

$$\begin{aligned} \text{Output} &= (\text{Fullscale} \div \text{Span})(\text{InValue} - \text{Null}) + \text{Offset} \\ (\text{Fullscale} \div \text{Span}) &= 16 \div 70 = 0.22857 \\ (\text{Value} - \text{Null}) &= -5 - (-20) = 15 \\ \text{Offset} &= 4 \\ \text{Output} &= 0.22857 \times 15 + 4 = 7.42\text{ mA} \end{aligned}$$

Example: Mapping a Distance

Map a distance input from a Node to a 0 to 10 V output. The starting distance is 200 mm and the last distance will be 2000 mm ($4\text{ mA} = 200\text{ mm}$ and $20\text{ mA} = 2000\text{ mm}$). This defines the null as 200 and the span as 1800.

With an input distance reading of 1560 mm, the output value will be:

$$\begin{aligned} \text{Output} &= (\text{Fullscale} \div \text{Span})(\text{InValue} - \text{Null}) + \text{Offset} \\ (\text{Fullscale} \div \text{Span}) &= 10 \div 1800 = 0.00555 \\ (\text{Value} - \text{Null}) &= 1560 - 200 = 1360 \\ \text{Offset} &= 0 \\ \text{Output} &= 0.00555 \times 1360 + 0 = 7.54\text{ V} \end{aligned}$$

Alarm Conditions. The standard alarm conditions are as follows:

Unsigned Alarm = 0xFFFF
Signed Alarm = 0x7FFF

If special alarm conditions are needed, consult the factory for details.

Blank page

Chapter Contents

DX80 Performance Documentation 51
 Troubleshooting..... 51
 Maintenance..... 55
 Sure Cross® Radio Certifications..... 58
 Contact Us..... 62
 Warnings 62
 Banner Engineering Corp Limited Warranty..... 63
 63

Chapter 6 Product Support and Maintenance

DX80 Performance Documentation

For additional information, including installation and configuration, weatherproofing, device menu maps, troubleshooting, and a list of accessories, refer to one of the following product manuals.

- DX80 Performance Quick Start Guide: [128185](#)
- DX80 Performance Wireless I/O Network Instruction Manual: [132607](#)
- Sure Cross® Accessories List [b_3147091](#)
- Sure Cross® Installation Guide: [151514](#)
- Conducting a Site Survey: [133602](#)
- Power Solutions and Battery Life Calculations: [140386](#)
- Antenna Basics: [132113](#)
- Sensor Connections: [136214](#)
- System Layouts: [133601](#)
- [Glossary](#) of Wireless Terminology

The following manuals are for the configuration software:

- DX80 Performance Configuration Software Instruction Manual: [140628](#)
- Sensor Configuration Software Instruction Manual: [170002](#)

For DX80 radios released prior to the Performance radios, refer to the following documents:

- DX80 Legacy Configuration Information: [b_4499713](#)

Troubleshooting

The following troubleshooting tips include some basic instructions for common problems.

Startup Problems

The following problems are associated with starting up your radios.

Troubleshooting startup problems

Problem	Solution
Radio won't wake up	While in storage mode , the radio does not operate. To put any integrated battery Sure Cross® radio into storage mode, press and hold button 1 for five seconds. To wake the device, press and hold button 1 for five seconds. The radio is in storage mode when the LEDs stop blinking, but in some models, the LCD remains on for an additional minute after the radio enters storage mode. After a device has entered storage mode, you must wait one minute before waking it.
Sensors are not powered	Many Sure Cross devices have several switch power outputs for powering sensors. Enable the power supplies using the I/O point parameters for sensor supply #, supply output voltage, and warm-up time.

Continued on page 52

Continued from page 51

Problem	Solution
Radio seems only partially powered	<p>If your ribbon cable has been unplugged from the radio board, verify the ribbon cable is fully seated and that it has been plugged into all pins. It is possible to accidentally plug in the ribbon cable and miss the top row of pins (shown). When the ribbon cable is plugged in incorrectly, the radio may partially power up, but it will not be able to communicate to any sensors nor will it communicate with the wireless network.</p> <p style="text-align: center;"><i>Ribbon cable</i></p> 
Radio won't enter binding mode	<p>If you did not disconnect the power before changing the DIP switch positions, you must cycle power to the device. If you do not cycle power, the device does not register the DIP switch changes. For devices with an integrated battery, cycle the power by removing the battery for one minute.</p>

LED Message Codes

Solid or flashing LEDs mean different things depending on whether the device is a Gateway, Node, or DX85 Remote I/O Modbus Slave.

LED message codes

LED 1	LED 2	Definition/Solution
Solid green		Gateway, DX85: Power is on
Flashing green		Node: Good radio communication link
	Flashing amber	Gateway, DX85: Active Modbus communication
Flashing red	Flashing red	<p>Device error. If the LCD also reports BAD EE, contact the factory for replacement.</p>
	Flashing red	<p>Gateway, DX85: Modbus communication error For a Gateway system, a Modbus communications error indicates a bad transmission or checksum error between the host and the Gateway device.</p> <p>Solutions:</p> <ol style="list-style-type: none"> 1. The default communications settings for the RS485 port are: 1 start bit, 8 data bits, no parity, 1 stop bit, and 19.2k baud. The DX80 Gateway uses Modbus RTU protocol for all communications. Supported Modbus function codes are 3, 6, and 16. 2. Verify the DX80 model supports RS485 serial communications. 3. RS485 termination or biasing is not supplied on the Gateway and should be provided externally to the DX80. (Termination is not required by the Gateway, proper biasing of the serial lines is required.) 4. Bad connection or bad cable.
	Flashing red	<p>Node: No radio communication There are two settings on every Node used to synchronize to the Gateway:</p> <ul style="list-style-type: none"> • The Node must be bound to the Gateway. • Each Node ID within that network must be set to a unique number. <p>Solutions:</p> <ol style="list-style-type: none"> 1. If the Gateway and Node are less than two meters apart, device communication may fail (radios may saturate). If the Gateway is less than two meters from another Gateway, send and receive transmissions between all devices the Gateways communicate with fails. 2. The Gateway and Node may be too far apart to achieve synchronization – consult the factory for options. 3. Use a qualified antenna on both the Gateway and Node devices. 4. After any system parameter change, cycle the power to re-synchronize all devices. 5. When a Node loses synchronization, it is programmed to attempt re-synchronization for five seconds, then sleep for fifteen seconds. Synchronizing may require up to twenty seconds. 6. Re-cycle power on the Gateway and Node devices.

Continued on page 53

Continued from page 52

LED 1	LED 2	Definition/Solution
No LED 1	No LED 2	<p>All DX80 devices display "POWER" on the LCD for the first five to ten seconds after applying power. A DX80 Gateway always has a green LED 1 on when power is connected. DX80 Node devices flash a red LED 2 every three seconds or a green LED 1 every second depending on the RF Link status.</p> <p>If no LEDs are lighting up:</p> <ol style="list-style-type: none"> 1. Put battery powered devices into power-down mode by pressing and holding button 1 for three to five seconds. To return from power-down mode, press and hold button 1 for three to five seconds. 2. Recheck the power connections and power requirements. Battery-powered devices require 3.6–5.5 V DC. Non-battery powered devices require 10–30 V DC. 3. After replacing the battery, allow up to sixty seconds for the device to power up.

LCD Message Codes

These message codes display on the device's LCD.

LCD message codes

Message	Solution
BAD EE	System Error. A system error typically represents a failure of the EE PROM. Contact the factory for replacement.
EC XX	The XX refers to the Modbus register 8 message code shown in "Modbus Message Codes for Register 8" on page 53 . The LCD displays the message code in decimal; host-controlled systems read the message codes in hex. DX80 display shows *ERROR: The Gateway uses fully-acknowledged polling to ensure each Node radio link is robust. If a prescribed number of sequential polling cycles are not acknowledged by a Node, the Gateway considers the radio link with that Node to be timed out. All outputs on the Node in question are set to the user-selected default state or the output holds its last state, depending on user configuration options set using the User Configuration Software. If the Node's radio link recovers and the Gateway determines enough acknowledged polling messages have accumulated, the link is reinstated.
EC 53	Radio Device (polling/heartbeat) Timeout. (Decimal value 13569.) A Node dropped out of the wireless network based on the parameters defined for polling or heartbeat. For more information, see Message Code 35 in "Modbus Message Codes for Register 8" on page 53 .
EC 54	Modbus time-out. A Gateway timeout (time of inactivity on the serial channel) was detected. For more information, see Message Code 36 in "Modbus Message Codes for Register 8" on page 53 .
No LCD	<p>All DX80s display "POWER" on the LCD for the first 5 to 10 seconds after applying power. A Gateway's LED 1 is solid green when power is connected. Nodes flash a red LED 2 every 3 seconds or a green LED 1 every second depending on the radio link status.</p> <ul style="list-style-type: none"> • Battery-powered devices turn off the LCD after 15 minutes (factory default). Push any button to reactivate the LCD. Battery-powered devices may be in storage mode. To put battery powered devices into storage mode, hold button 1 for 5 seconds. To return from storage mode, hold button 1 for 5 seconds. • Recheck the power connections and power requirements. Battery-powered devices require 3.6 to 5.5 V DC. Non-battery powered devices require 10 to 30 V DC. • After replacing the battery, allow up to sixty seconds for the device to power up.

Modbus Message Codes for Register 8

Register I/O 8 is reserved for device messages or Site Survey data when in Site Survey mode.

Conditions are detected as they occur and are reported to the Gateway. After the message is sent to the Gateway, the Node does not resend the message until the condition changes or there is a higher priority message. The higher the message code, the higher the priority. For more information about how Site Survey data is stored in registers 7 and 8, refer to ["Conducting a Site Survey \(Gateway and Nodes\)" on page 17](#).

The following are the Modbus message codes, shown in hex, that may appear on the Sure Cross devices' I/O 8 Modbus register.

Modbus message codes for register 8

Message Code [15:8]	Data Field [7:0]	Description
00	80	Normal operation. Device message register contents 0x0080 indicate the Node is synchronized to the Gateway. (Decimal value 128.) A value of zero (0) indicates there is no device present.
01	00-FF	Unknown message. The message was received correctly (correct checksum), but it is not a recognized command. This type of message is usually caused by devices with poor radio links or collocated networks that are not uniquely separated by binding codes and Network IDs. Network performance is not affected. (Decimal values 256 through 511.)

Continued on page 54

Continued from page 53

Message Code [15:8]	Data Field [7:0]	Description
35	01	Radio Device (polling/heartbeat) Timeout. (Decimal value 13569.) A Node dropped out of the wireless network based on the polling or heartbeat parameters. Refer to the User Configuration Tool documentation for polling or heartbeat parameters and the timeout operation. When the least significant bit is on (1), an error condition exists. <ul style="list-style-type: none"> Run a site survey to determine the quality of the radio link. If no communication exists between the Gateway and Node, verify the power at the Node and all antenna connections. Blocked radio communications may also be a result of recently changed environmental conditions. Replace the battery of a battery-powered Node. Although the LCD and device may appear functional, the battery may not have enough capacity to handle radio communication.
36	01	Modbus time-out. A Gateway timeout (inactivity on the serial channel) was detected. (Decimal value 13825.) When the least significant bit is on (1), an error condition exists.
FE	--	Modbus register 8 device messages are disabled. The Modbus register 8 clears or disables messages using the Gateway's Modbus register 15. (Decimal values 65024 through 65279.)

Inputs and Outputs

Troubleshooting the inputs and outputs

Problem	Solution
Some inputs or outputs are not working	Option 1. From the Node, access the menu system and use manual scrolling mode within *RUN to freeze the I/O status on the LCD display for the device in question. Verify that when the input device changes state or changes value, the LCD mirrors the behavior.
	If the Node is in a hazardous location, access the Node's I/O from the Gateway by changing the Gateway's right rotary dial to the Node number in question. For example, to view the I/O status of Node 3, move the Gateway's right rotary dial to 3. The Gateway's LCD now scrolls through Node 3's I/O. To freeze the display on a particular I/O point, double-click button 2. The autoscrolling on the Gateway stops at the *RUN screen. Single-click button 1 to advance through the Node's I/O points.
	Option 2. Verify the LCD on the output side mirrors the linked input's behavior. If the input device state LCD on the origination DX80 and the LCD on the destination DX80 behave the same, there may be a wiring issue or an interfacing problem. Consult the factory.
	Option 3. Nodes will not sample inputs unless the Nodes are in sync with a Gateway. Verify your Node is in sync with its Gateway.

Radio Link Time-Out and Recovery (Non-Host Connected Systems)

The Sure Cross® wireless devices employ a deterministic link time-out method to address radio link interruption or failure. When a specific Node/Gateway radio link fails, all pertinent wired outputs are de-energized until the link is recovered (see component datasheet for more information.) Through this process, users of Banner wireless networks can be assured that disruptions in the communications link result in predictable system behavior.

The link time-out feature uses a fully-acknowledged polling method to determine the radio link status of each Node on the network.

If after a specified number of sequential polling cycles the Node does not acknowledge a message, the Gateway considers the link with that Node timed out. The LCDs on both the Node and Gateway show *ERROR. Following a time-out, the Node de-energizes outputs and the Gateway sets all outputs linked to the Node in question to a de-energized state. Inputs from the Node mapped to outputs on the Gateway are suspended during a link time-out.

Radio link between the Gateway and Node 1 has timed out.

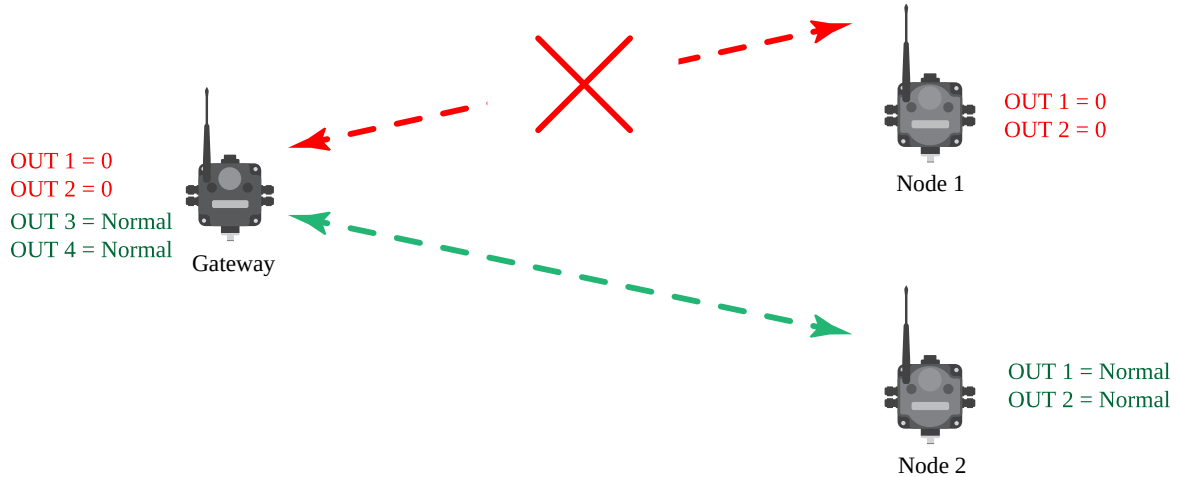

After a link has failed, the Gateway must receive a specified number of good data packets from the Node in question before the link is reinstated. Outputs are restored to current values after the link recovers.

Radio link between the Gateway and Node 1 has recovered.

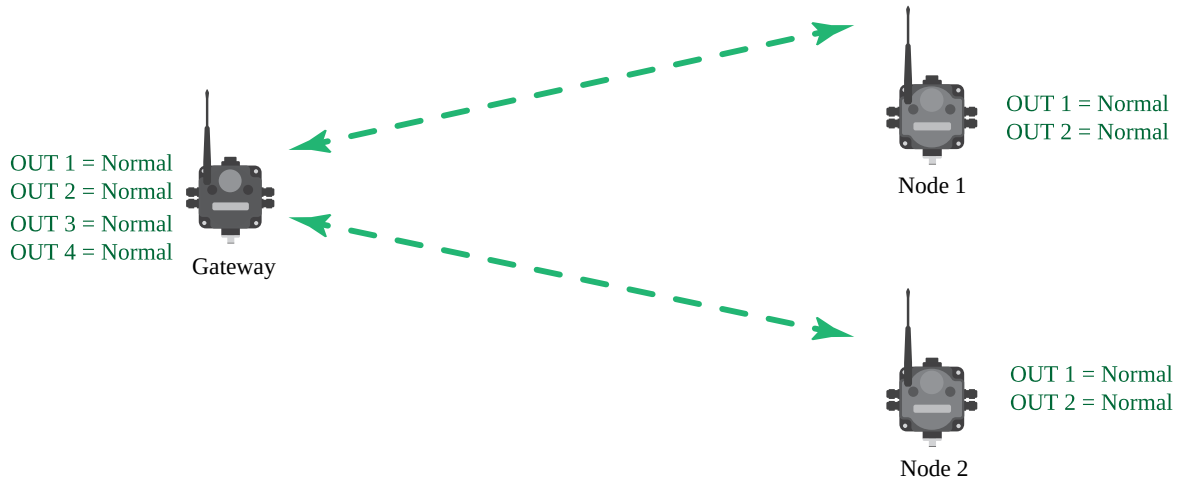

Maintenance

Follow these instructions to perform basic maintenance tasks.

Replacing the Main Body Gasket

Check the main body gasket after a Sure Cross device is opened.

Replace the gasket when it is damaged, discolored, or showing signs of wear. The gasket must be:

- Fully seated within its channel along the full length of the perimeter, and
- Positioned straight within the channel with no twisting, stress, or stretching.

Replacing the main body gasket



Replacing the Rotary Dial Access Cover

Check the rotary dial access cover o-ring every time the access cover is removed.

Replace the o-ring when it is damaged, discolored, or showing signs of wear. The o-ring should be:

- Seated firmly against the threads without stretching to fit or without bulging loosely, and
- Pushed against the flanged cover.

Replacing the rotary dial access cover



When removing or closing the rotary dial access cover, manually twist the cover into position. Do not allow cross-threading between the cover and the device's face. After the cover is in place and manually tightened, use a small screwdriver (no longer than five inches total length) as a lever to apply enough torque to bring the rotary dial access cover even with the cover surface.

Install or Replace the Battery for a DX81 Model

To replace the lithium "D" cell battery in the FlexPower Supply Module, follow these steps.

1. Unplug the **DX81-LITH** or **DX81H** FlexPower Supply Module from the Sure Cross® device it powers.
2. Remove the four screws mounting the battery module face plate to the body and remove the face plate.
3. Remove the discharged battery by pressing the battery towards the negative terminal to compress the spring. Pry up on the battery's positive end to remove it from the battery holder.
4. Install the new battery or batteries.
5. Verify the battery's positive and negative terminals align to the positive and negative terminals of the battery holder mounted within the case. Caution: There is a risk of explosion if the battery is replaced incorrectly.
6. After replacing the battery, allow up to 60 seconds for the device to power up.
7. Properly dispose of your used battery according to local regulations by taking it to a hazardous waste collection site, an e-waste disposal center, or any other facility qualified to accept lithium batteries.



For outside or high humidity environments, dielectric grease may be applied to the battery terminals to prevent moisture and corrosion buildup.

As with all batteries, these are a fire, explosion, and severe burn hazard. Do not burn or expose them to high temperatures. Do not recharge, crush, disassemble, or expose the contents to water.

The battery may be replaced in explosive gas atmospheres.

For non-hazardous locations, the replacement battery is model **BWA-BATT-011**. For non-hazardous or hazardous locations, the replacement battery is Xeno model XL-205F, Banner model **BWA-BATT-001**. For pricing and availability, contact Banner Engineering.

WARNING:



- Potential electrostatic charging hazard — only clean with a damp cloth.
- The replacement battery **MUST** be a Banner-approved battery, model number **BWA-BATT-001**. Use of a different battery will **VOID** the intrinsic safety rating of this device and may result in an explosion!
- When replacing the battery, the negative end of the battery holder is the side with the spring terminal. This side is marked with a minus (-) sign.
- Do not attempt to recharge the battery. These batteries are not rechargeable. Recharging may cause serious injury to personnel or damage the equipment. Replace only with factory recommended batteries.

Install or Replace the Battery for a DX80 Integrated Battery Model

To install or replace the 3.6 V lithium "D" cell battery in any model with a battery integrated into the housing, follow these steps.

1. Remove the four screws mounting the face plate to the housing and remove the face plate.
2. Remove the discharged battery.
3. Install the new battery, verifying the battery's positive and negative terminals align to the positive and negative terminals of the battery holder mounted within the case.
4. After installing the battery, allow up to 60 seconds for the device to power up.
5. Properly dispose of used batteries according to local regulations by taking it to a hazardous waste collection site, an e-waste disposal center, or another facility qualified to accept lithium batteries.

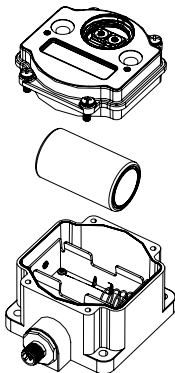

CAUTION: There is a risk of explosion if the battery is replaced incorrectly.

As with all batteries, these are a fire, explosion, and severe burn hazard. Do not burn or expose them to high temperatures. Do not recharge, crush, disassemble, or expose the contents to water.

For non-hazardous locations, the replacement battery is model **BWA-BATT-011**. For non-hazardous or hazardous locations, the replacement battery is Xeno model XL-205F, Banner model **BWA-BATT-001**. For pricing and availability, contact Banner Engineering.

Install or Replace the Battery (DX99...D Models)

WARNING:



- Do not replace battery when an explosive dust atmosphere may be present.
- The replacement battery **MUST** be a Banner-approved battery, model number **BWA-BATT-001**. Use of a different battery will **VOID** the intrinsic safety rating of this device and may result in an explosion!
- When replacing the battery, the negative end of the battery holder is the side by the large capacitors. This side is marked with a minus (-) sign.
- Do not attempt to recharge the battery. These batteries are not rechargeable. Recharging may cause serious injury to personnel or damage the equipment. Replace only with factory recommended batteries.

To install or replace the lithium "D" cell battery in the metal housings, follow these steps.

1. Unscrew the lid of the metal enclosure.
2. Lift the radio out of the metal enclosure and pull the spacer frame off the back side of the radio.
3. Disconnect the radio by unplugging the ribbon cable from the radio board and set aside the radio and spacer frame.
4. If you are replacing an existing battery, remove the discharged battery.
5. Insert a new battery. Only use a 3.6 V lithium battery from Xeno, model number XL-205F.
6. Verify the battery's positive and negative terminals align to the positive and negative terminals of the battery holder mounted within the case. Caution: There is a risk of explosion if the battery is replaced incorrectly.
7. Wait two minutes.
8. Insert the ribbon cable through the center of the spacer frame, then plug the ribbon cable back into the radio board.
9. Insert the radio back onto the spacer frame pins. Push the radio and spacer frame assembly back into the enclosure until it is seated.
10. Screw on the lid and tighten.
11. After replacing the battery, allow up to 60 seconds for the device to power up.
12. Properly dispose of your used battery according to local regulations by taking it to a hazardous waste collection site, an e-waste disposal center, or other facility qualified to accept lithium batteries.



As with all batteries, these are a fire, explosion, and severe burn hazard. Do not burn or expose them to high temperatures. Do not recharge, crush, disassemble, or expose the contents to water.

The battery may be replaced in explosive gas atmospheres. Replacement battery model number: BWA-BATT-001. For pricing and availability, contact Banner Engineering.

Sure Cross® Radio Certifications

Banner's Sure Cross product line is certified by the FCC, European Union, and many other countries for operation within specific radio frequencies.

FCC Part 15 Class A for Intentional Radiators

This equipment has been tested and found to comply with the limits for a Class A digital device, pursuant to part 15 of the FCC Rules. These limits are designed to provide reasonable protection against harmful interference when the equipment is operated in a commercial environment. This equipment generates, uses, and can radiate radio frequency energy and, if not installed and used in accordance with the instruction manual, may cause harmful interference to radio communications. Operation of this equipment in a residential area is likely to cause harmful interference in which case the user will be required to correct the interference at his own expense.

Industry Canada Statement for Intentional Radiators

This device contains licence-exempt transmitter(s)/receiver(s) that comply with Innovation, Science and Economic Development Canada's licence-exempt RSS(s). Operation is subject to the following two conditions:

1. This device may not cause interference.
2. This device must accept any interference, including interference that may cause undesired operation of the device.

Cet appareil contient des émetteurs/récepteurs exemptés de licence conformes à la norme Innovation, Sciences, et Développement économique Canada. L'exploitation est autorisée aux deux conditions suivantes:

1. L'appareil ne doit pas produire de brouillage.
2. L'utilisateur de l'appareil doit accepter tout brouillage radioélectrique subi, même si le brouillage est susceptible d'en compromettre le fonctionnement.

FCC and ISED Certification, 900 MHz, 1 Watt Radios

This equipment contains transmitter module RM1809 or SX7023EXT.

Radio Module RM1809	Radio Module SX7023EXT
FCC ID: UE3RM1809	FCC ID: UE3SX7023EXT
IC: 7044A-RM1809	IC: 7044A-SX7023EXT
HVIN: RM1809	HVIN: 223150

FCC Notices

IMPORTANT: The transmitter modules RM1809 and SX7023EXT have been certified by the FCC / ISED for use with other products without any further certification (as per FCC section 2.1091). Changes or modifications not expressly approved by the manufacturer could void the user's authority to operate the equipment.

IMPORTANT: The transmitter modules RM1809 and SX7023EXT have been certified for fixed base station and mobile applications. If modules will be used for portable applications, the device must undergo SAR testing.

IMPORTANT: If integrated into another product, the FCC ID label must be visible through a window on the final device or it must be visible when an access panel, door, or cover is easily removed. If not, a second label must be placed on the outside of the final device that contains the following text:

Transmitter Module [RM1809 or SX7023EXT]
 Contains FCC ID: [UE3RM1809 or UE3SX7023EXT]
 Contains IC: [7044A-RM1809 or 7044A-SX7023EXT]
 HVIN: [RM1809 or 223150]

This device complies with Part 15 of the FCC Rules. This equipment generates, uses, and can radiate radio frequency energy and, if not installed and used in accordance with the instruction manual, may cause harmful interference to radio communications. Operation is subject to the following two conditions: 1) This device may not cause harmful interference; and 2) This device must accept any interference received, including interference that may cause undesired operation.

Antenna WARNING: This device has been tested with Reverse Polarity SMA connectors with the antennas listed in "[Certified Antennas for 900 MHz 1 Watt](#)" on page 60. When integrated into OEM products, fixed antennas require installation preventing end-users from replacing them with non-approved antennas. Antennas not listed in the tables must be tested to comply with FCC Section 15.203 (unique antenna connectors), FCC Section 15.247 (emissions), and ISED RSS-Gen Section 6.8.

FCC and ISED Approved Antennas

WARNING: Antenna(s) used for this transmitter must be installed to provide a separation distance of at least 20 cm from all persons.

AVERTISSEMENT : Les antennes utilisées pour cet émetteur doivent être installées de manière à assurer une distance de séparation d'au moins 20 cm de toutes les personnes.

NOTICE: This equipment is approved only for mobile and base station transmitting devices. The antenna(s) used for this transmitter must not transmit simultaneously with any other antenna or transmitter, except in accordance with FCC multi-transmitter product procedures.

The radio transmitter modules RM1809 and SX7023EXT have been approved by FCC and ISED Canada to operate with the antenna types listed below, with the maximum permissible gain indicated. Antenna types not included in this list that have a gain greater than the maximum gain indicated for any type listed are strictly prohibited for use with this device.

Certified Antennas for 900 MHz 1 Watt

Model Number	Antenna Type	900 MHz Radio Module	Maximum Gain	Impedance	Minimum Required Cable/Connector Loss
-	Integral Antenna	RM1809	Unity gain		0
BWA-901-x	Omni, 1/4 wave dipole	RM1809	≤2 dBi	50 Ω	0
BWA-902-C	Omni, 1/2 wave dipole, Swivel	RM1809 or SX7023EXT	≤2 dBi	50 Ω	0
BWA-906-A	Omni Wideband, Fiberglass Radome	RM1809	≤8.2 dBi	50 Ω	2.2 dB
BWA-905-B	Omni Base Whip	RM1809	≤7.2 dBi	50 Ω	1.2 dB
BWA-9Y10-A	Yagi	RM1809	≤10 dBi	50 Ω	4 dB
BWA-905-C	Coaxial sleeve	SX7023EXT	≤5 dBi	50 Ω	0
BWA-906-AS	Omni	SX7023EXT	≤6 dBi	50 Ω	0

FCC and ISED Certification, 2.4GHz

This equipment contains transmitter module DX80-2400 or SX243.

Radio Module DX80-2400	Radio Module SX243
FCC ID: UE300DX80-2400	FCC ID: UE3SX243
IC: 7044A-DX8024	IC: 7044A-SX243
HVIN: DX80G2 / DX80N2	HVIN: SX243

FCC Notices

IMPORTANT: The transmitter modules DX80-2400 and SX243 have been certified by the FCC / ISED for use with other products without any further certification (as per FCC section 2.1091). Changes or modifications not expressly approved by the manufacturer could void the user's authority to operate the equipment.

IMPORTANT: The transmitter modules DX80-2400 and SX243 have been certified for fixed base station and mobile applications. If modules will be used for portable applications, the device must undergo SAR testing.

IMPORTANT: If integrated into another product, the FCC ID/IC label must be visible through a window on the final device or it must be visible when an access panel, door, or cover is easily removed. If not, a second label must be placed on the outside of the final device that contains the following text:

Transmitter Module [DX80-2400 or SX243]
 Contains FCC ID: [UE300DX80-2400 or UE3SX243]
 Contains IC: [7044A-DX8024 or 7044A-SX243]
 HVIN: [DX80G2, DX80N2 or SX243]

This device complies with Part 15 of the FCC Rules. This equipment generates, uses, and can radiate radio frequency energy and, if not installed and used in accordance with the instruction manual, may cause harmful interference to radio communications. Operation is subject to the following two conditions: 1) This device may not cause harmful interference; and 2) This device must accept any interference received, including interference that may cause undesired operation.

Antenna Warning: This device has been tested with Reverse Polarity SMA connectors with the antennas listed in "[Certified Antennas for 2.4 GHz](#)" on page 61. When integrated into OEM products, fixed antennas require installation preventing end-

users from replacing them with non-approved antennas. Antennas not listed in the tables must be tested to comply with FCC Section 15.203 (unique antenna connectors), FCC Section 15.247 (emissions), and ISED RSS-Gen Section 6.8.

FCC and ISED Approved Antennas

WARNING: Antenna(s) used for this transmitter must be installed to provide a separation distance of at least 20 cm from all persons.

AVERTISSEMENT : Les antennes utilisées pour cet émetteur doivent être installées de manière à assurer une distance de séparation d'au moins 20 cm de toutes les personnes.

NOTICE: This equipment is approved only for mobile and base station transmitting devices. The antenna(s) used for this transmitter must not transmit simultaneously with any other antenna or transmitter, except in accordance with FCC multi-transmitter product procedures.

The radio transmitter modules DX80-2400 and SX243 have been approved by FCC and ISED Canada to operate with the antenna types listed below, with the maximum permissible gain indicated. Antenna types not included in this list that have a gain greater than the maximum gain indicated for any type listed are strictly prohibited for use with this device.

Certified Antennas for 2.4 GHz

Model	Antenna Type	2.4 GHz Radio Module	Maximum Gain	Impedance
	Integral antenna	DX80-2400 or SX243	Unity gain	
BWA-202-C	Omni, 1/2 wave dipole, Swivel	DX80-2400 or SX243	≤ 2 dBi	50 Ω
BWA-202-D	Omni, Dome, Box Mount	DX80-2400 or SX243	≤ 2 dBi	50 Ω
BWA-202-E	Omni, 1/4 wave dipole, Swivel	DX80-2400 or SX243	≤ 2 dBi	50 Ω
BWA-205-C	Omni, Collinear, Swivel	DX80-2400	≤ 5 dBi	50 Ω
BWA-205-MA	Omni, full-wave dipole, NMO	DX80-2400	≤ 4.5 dBi	50 Ω
BWA-206-A	Omni, Dome, Box Mount	DX80-2400	≤ 6 dBi	50 Ω
BWA-207-C	Omni, Coaxial Sleeve, Swivel	DX80-2400	≤ 7 dBi	50 Ω

Exporting Sure Cross® Radios

Exporting Sure Cross® Radios. It is our intent to fully comply with all national and regional regulations regarding radio frequency emissions. **Customers who want to re-export this product to a country other than that to which it was sold must ensure the device is approved in the destination country.** The Sure Cross wireless products were certified for use in these countries using the antenna that ships with the product. When using other antennas, verify you are not exceeding the transmit power levels allowed by local governing agencies. This device has been designed to operate with the antennas listed on Banner Engineering's website and having a maximum gain of 9 dBm. Antennas not included in this list or having a gain greater than 9 dBm are strictly prohibited for use with this device. The required antenna impedance is 50 ohms. To reduce potential radio interference to other users, the antenna type and its gain should be so chosen such that the equivalent isotropically radiated power (EIRP) is not more than that permitted for successful communication. Consult with Banner Engineering Corp. if the destination country is not on this list.

International Certifications for Sure Cross® Radios

Country	Agency	ISM Radio Frequency	Radio Module	Statement
Brazil	ANATEL	2.4 GHz	UE300DX80-2400	15966-21-04042: Este equipamento não tem direito à proteção contra interferência prejudicial e não pode causar interferência em sistemas devidamente autorizados. Para maiores informações, consulte o site da ANATEL www.gov.br/anatel/pt-br/

Continued on page 62

Continued from page 61

Country	Agency	ISM Radio Frequency	Radio Module	Statement
Brazil	ANATEL	2.4 GHz	UE3SX243	03737-22-04042: Este equipamento não tem direito à proteção contra interferência prejudicial e não pode causar interferência em sistemas devidamente autorizados. Para maiores informações, consulte o site da ANATEL www.gov.br/anatel/pt-br/
Canada	IC	900 MHz, 1 Watt	UE3RM1809	IC: 7044A-RM1809
Canada	IC	2.4 GHz	UE300DX80-2400	IC: 7044A-DX8024
Canada	IC	2.4 GHz	UE3SX243	IC: 7044A-SX243
European Union		2.4 GHz	UE300DX80-2400	Radio Equipment Directive (RED) 2014/53/EU
European Union		2.4 GHz	UE3SX243	Radio Equipment Directive (RED) 2014/53/EU
Japan	ACB	2.4 GHz	UE3SX243	The 8.5 dBi antenna must be used with a cable that has at least 1.1 dB loss to meet the 6.91 dBm/MHz EIRP limit.
Korea		2.4 GHz	UE300DX80-2400	KCC-CRM-BE2-DX
Mexico	NOM/IFT	900 MHz, 1 Watt	UE3RM1809	IFT: RCPBARM13-2283
United States	FCC	900 MHz, 1 Watt	UE3RM1809	FCC ID: UE3RM1809: FCC Part 15, Subpart C, 15.247
United States	FCC	2.4 GHz	UE300DX80-2400	FCC ID: UE300DX80-2400: FCC Part 15, Subpart C, 15.247
United States	FCC	2.4 GHz	UE3SX243	FCC ID: UE3SX243: FCC Part 15, Subpart C, 15.247

International certifications are not inclusive of all Banner Engineering Sure Cross® Radios. For product-specific certifications, contact a local Banner Engineering representative.

Contact Us

Banner Engineering Corp. headquarters is located at: 9714 Tenth Avenue North | Minneapolis, MN 55441, USA | Phone: + 1 888 373 6767

For worldwide locations and local representatives, visit www.bannerengineering.com.

Warnings

WARNING:



- **Do not use this device for personnel protection**
- Using this device for personnel protection could result in serious injury or death.
- This device does not include the self-checking redundant circuitry necessary to allow its use in personnel safety applications. A device failure or malfunction can cause either an energized (on) or de-energized (off) output condition.

IMPORTANT: Please download the complete Gateway or Node technical documentation, available in multiple languages, from www.bannerengineering.com for details on the proper use, applications, Warnings, and installation instructions of this device.

IMPORTANT: Por favor descargue desde www.bannerengineering.com toda la documentación técnica de los Gateway or Node, disponibles en múltiples idiomas, para detalles del uso adecuado, aplicaciones, advertencias, y las instrucciones de instalación de estos dispositivos.

IMPORTANT: Veuillez télécharger la documentation technique complète des Gateway or Node sur notre site www.bannerengineering.com pour les détails sur leur utilisation correcte, les applications, les notes de sécurité et les instructions de montage.

Install and properly ground a qualified surge suppressor when installing a remote antenna system. Remote antenna configurations installed without surge suppressors invalidate the manufacturer's warranty. Keep the ground wire as short as possible and make all ground connections to a single-point ground system to ensure no ground loops are created. No surge

suppressor can absorb all lightning strikes; do not touch the Sure Cross® device or any equipment connected to the Sure Cross® device during a thunderstorm.

Exporting Sure Cross® Radios. It is our intent to fully comply with all national and regional regulations regarding radio frequency emissions. **Customers who want to re-export this product to a country other than that to which it was sold must ensure the device is approved in the destination country.** The Sure Cross wireless products were certified for use in these countries using the antenna that ships with the product. When using other antennas, verify you are not exceeding the transmit power levels allowed by local governing agencies. This device has been designed to operate with the antennas listed on Banner Engineering's website and having a maximum gain of 9 dBm. Antennas not included in this list or having a gain greater than 9 dBm are strictly prohibited for use with this device. The required antenna impedance is 50 ohms. To reduce potential radio interference to other users, the antenna type and its gain should be so chosen such that the equivalent isotropically radiated power (EIRP) is not more than that permitted for successful communication. Consult with Banner Engineering Corp. if the destination country is not on this list.

IMPORTANT:

- **Never operate a 1 Watt radio without connecting an antenna**
- Operating 1 Watt radios without an antenna connected will damage the radio circuitry.
- To avoid damaging the radio circuitry, never apply power to a Sure Cross® Performance or Sure Cross MultiHop (1 Watt) radio without an antenna connected.

IMPORTANT:

- **Electrostatic discharge (ESD) sensitive device**
- ESD can damage the device. Damage from inappropriate handling is not covered by warranty.
- Use proper handling procedures to prevent ESD damage. Proper handling procedures include leaving devices in their anti-static packaging until ready for use; wearing anti-static wrist straps; and assembling units on a grounded, static-dissipative surface.

Banner Engineering Corp Limited Warranty

Banner Engineering Corp. warrants its products to be free from defects in material and workmanship for one year following the date of shipment. Banner Engineering Corp. will repair or replace, free of charge, any product of its manufacture which, at the time it is returned to the factory, is found to have been defective during the warranty period. This warranty does not cover damage or liability for misuse, abuse, or the improper application or installation of the Banner product.

THIS LIMITED WARRANTY IS EXCLUSIVE AND IN LIEU OF ALL OTHER WARRANTIES WHETHER EXPRESS OR IMPLIED (INCLUDING, WITHOUT LIMITATION, ANY WARRANTY OF MERCHANTABILITY OR FITNESS FOR A PARTICULAR PURPOSE), AND WHETHER ARISING UNDER COURSE OF PERFORMANCE, COURSE OF DEALING OR TRADE USAGE.

This Warranty is exclusive and limited to repair or, at the discretion of Banner Engineering Corp., replacement. **IN NO EVENT SHALL BANNER ENGINEERING CORP. BE LIABLE TO BUYER OR ANY OTHER PERSON OR ENTITY FOR ANY EXTRA COSTS, EXPENSES, LOSSES, LOSS OF PROFITS, OR ANY INCIDENTAL, CONSEQUENTIAL OR SPECIAL DAMAGES RESULTING FROM ANY PRODUCT DEFECT OR FROM THE USE OR INABILITY TO USE THE PRODUCT, WHETHER ARISING IN CONTRACT OR WARRANTY, STATUTE, TORT, STRICT LIABILITY, NEGLIGENCE, OR OTHERWISE.**

Banner Engineering Corp. reserves the right to change, modify or improve the design of the product without assuming any obligations or liabilities relating to any product previously manufactured by Banner Engineering Corp. Any misuse, abuse, or improper application or installation of this product or use of the product for personal protection applications when the product is identified as not intended for such purposes will void the product warranty. Any modifications to this product without prior express approval by Banner Engineering Corp will void the product warranties. All specifications published in this document are subject to change; Banner reserves the right to modify product specifications or update documentation at any time. Specifications and product information in English supersede that which is provided in any other language. For the most recent version of any documentation, refer to: www.bannerengineering.com.

For patent information, see www.bannerengineering.com/patents.

Document title: Sure Cross DX80 Performance Wireless IO Network Instruction Manual

Part number: 132607

Revision: R

© Banner Engineering Corp. All rights reserved.

 [LinkedIn](#)

 [Twitter](#)

 [Facebook](#)

