

Antenna Basics

This Antenna Basics reference guide includes basic information about antenna types, how antennas work, gain, and some installation examples.

What Do Antennas Do?

Antennas transmit radio signals by converting radio frequency electrical currents into electromagnetic waves. Antennas receive the signals by converting the electromagnetic waves back into radio frequency electrical currents.

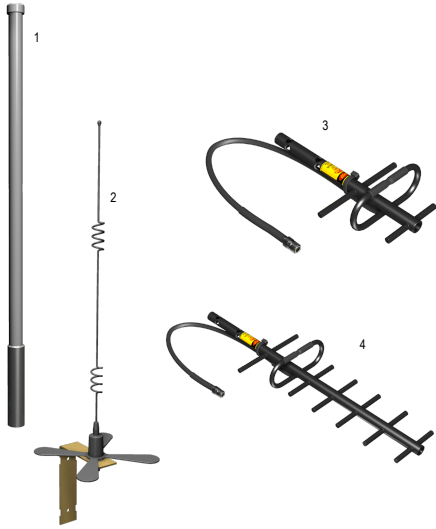

Because electromagnetic waves do not require a medium in which to travel, antennas can function in air, space, under water or other liquid, and even through solid matter for limited distances. Every antenna has specific characteristics that determine the signal's range and radiation pattern or shape.

1. Omni antenna with radome
2. Omni antenna with ground plane
3. Low-gain Yagi antenna
4. High-gain Yagi antenna

Anatomy of an Antenna

There are many components to an antenna system, including the parts of the antenna and the cabling used to connect the antenna to the radio.

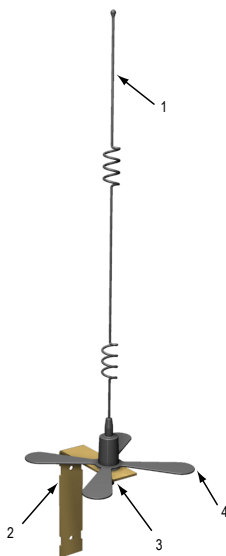

1. Antenna element
2. Mounting bracket
3. N-type connector
4. Ground plane





Antenna extension cable with an SMA connector at one end and an N-type male connector at the other end. This cable typically connects between the SureCross® device and the antenna or another extension cable.



Antenna extension cable with an N-type male connector at one end and an N-type female connector at the other end. This extension cable connects between another cable and a surge protector or antenna.



Surge suppressors mount between the antenna and the radio system to protect the electrical equipment from damage during a lightning strike or other electrical surge. No surge suppressor can absorb all lightning strikes. Do not touch any radio device or any equipment connected to the radio device during a thunderstorm.



CAUTION: Always install and properly ground a qualified surge suppressor when installing a remote antenna system. Remote antenna configurations installed without surge suppressors invalidate the Banner Engineering Corp. warranty. Always keep the ground wire as short as possible and make all ground connections to a single-point ground system to ensure no ground loops are created.

Antenna Gain

The antenna's gain, measured in decibels, relates directly to the radio signal's radiation pattern and range.

Adding gain to a radio system does not amplify the signal. Antennas with greater gain only focus the signal. A low-gain antenna transmits (and receives) the radio signal equally in all directions. A high-gain antenna transmits its signal farther in one direction than the low-gain system.

Decibels

Mathematical equations indicate that for every 3 dB increase in the gain, the effective transmission power doubles.

Experimentation indicates that for every 6 dB increase in the gain, the radio signal range doubles. Therefore, if a 0 dB antenna (unity gain) transmits three miles, a 6 dB antenna on the same radio transmits the signal six miles.

To simplify conversions between dBi, dBm, dBd, use the following approximation: $\text{dBm} = \text{dBi} = \text{dBd} + 2.15$, where dBm refers to a ratio of the measured power referenced to 1 milliwatt, dBi is a measurement of an antenna's gain compared to a mathematically ideal isotropic antenna, and dBd is a ratio of the antenna's forward gain to a half-wave dipole antenna.

Why Do You Need Gain?

According to rules set by the FCC, radio systems like the SureCross® radio device may not exceed 30 dBm Effective Isotropic Radiated Power (EIRP), or approximately 1 Watt. Because the 900 MHz SureCross radio system has a conducted power of 21 dBm (150 mW), the maximum system gain that may be used with the Banner system is 9 dBm. Using these higher gain antennas allows users to focus the signal both for transmission and for reception.

For systems requiring cables and connectors, the losses from the cables and connectors add up to reduce the effective transmission power of a radio network. What starts out as a 9 dB antenna may only have an effective gain of 5 dB once losses are totaled. Because the 9 dB limit applies to the radio system, including connectors and cables, using a higher gain antenna may be necessary to transmit the required distance and would still comply with FCC regulations.

In addition to increasing the range, adding gain changes the radiation pattern. How the radiation pattern changes depends on the type of antenna: omni-directional or directional.

Line of Sight

Accurate radio transmission depends on a clear path between radio antennas known as the line of sight.

Obstructions, including buildings, trees, or terrain, that interrupt the visual path between antennas also interfere with the radio signal transmission, resulting in multi-path fade or increased signal attenuation. **Multi-path fade** is the result of radio signals reaching the receiver via two or more paths. In industrial settings, received radio signals may include the line of sight signal and signals reflected off buildings, equipment, or outdoor terrain. **Signal attenuation** is the decrease in signal strength as a result of travel through the medium, in this case the air.

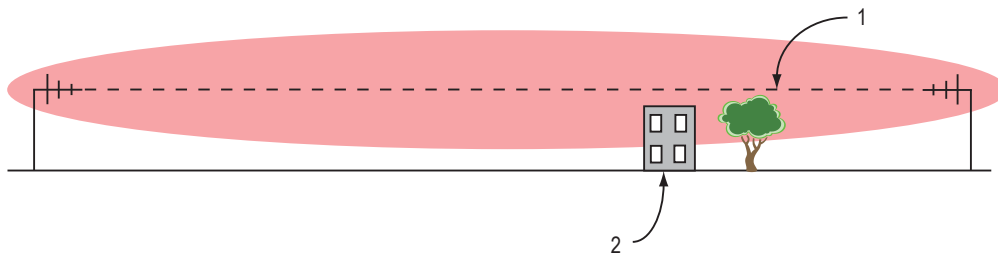

1. Line of sight
2. Obstruction in the "lobe" (Fresnel zone) of the radio signal.

Despite a clear line of sight, obstructions in the Fresnel zone, a three-dimensional ellipsoid formed with the two antennas as the foci, will still interfere with the radio signal and cause multi-path fade. Raise the antennas high enough to clear any obstructions. Ideally there should be no obstructions in the Fresnel zone. If a radio network site is spread over a large area with multiple obstructions or a variety of terrain, conduct a site survey to determine optimum antenna locations, antenna mounting heights, and recommended gains for reliable performance.

Omni-Directional Antennas

Omni-directional antennas mount vertically and transmit and receive equally in all directions within the horizontal plane. Omni-directional antennas are used with the Sure Cross® Gateway, because the Gateway is usually at the center of the star topology radio network.

An omni-directional, or omni, antenna transmits and receives radio signals in the 'doughnut' pattern shown. Note the lack of a signal very close to the antenna. Most dipole omni antennas have a minimum distance for optimum signal reception.

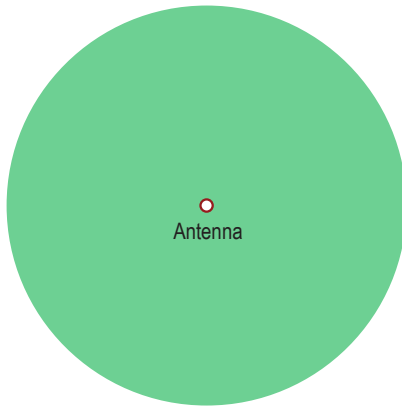

From the top view, the signal radiates equally in all directions from the antenna. For this reason, omni-directional antennas are best used for the device in the center of a star topology network.

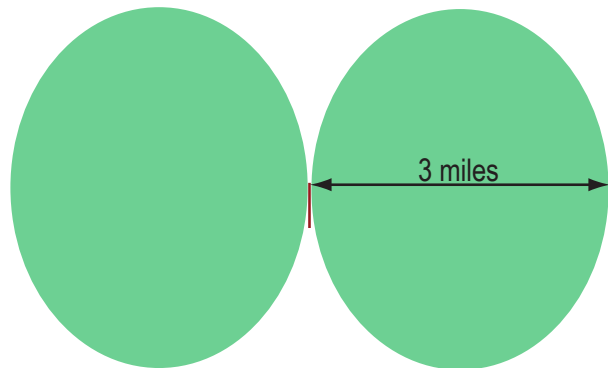

Viewed from the side, however, the radiation pattern of an omni-directional antenna is doughnut shaped.

With the star topology network, using an omni-directional antenna on the Gateway that ensures all Nodes fall within the antenna radiation pattern.

Low Gain Omni-Directional Antennas

Low-gain omni-directional antennas work well in multipath industrial environments, such as inside metal buildings. High-gain antennas work well in line-of-sight conditions. Using an omni-directional antenna in the center of a star topology ensures all radio devices receive a signal.

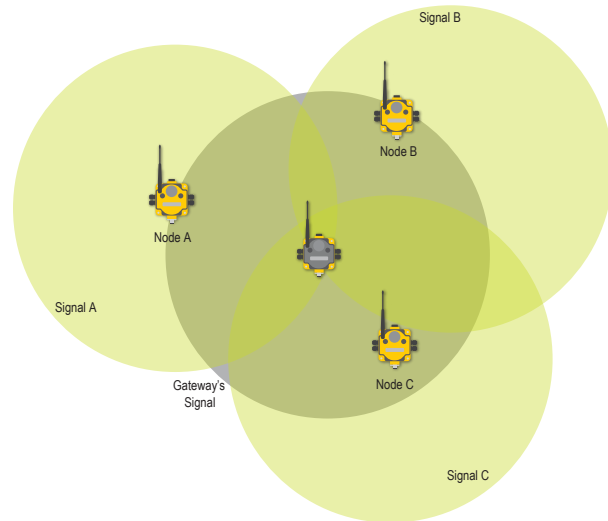

High Gain Omni-Directional Antennas

A high gain omni antenna with increased gain also has a circular radiation pattern when viewed from the top. From the side view, however, the decreased energy sent vertically increases the energy transmitted horizontally. The radiation pattern stretches to extend the range, focusing the signal along a horizontal plane. This makes higher gain omni antennas more sensitive to changes in elevation between the Gateway and its Nodes.

Increasing the gain of omni-directional antennas results in less energy sent vertically and more energy sent horizontally, extending the range.

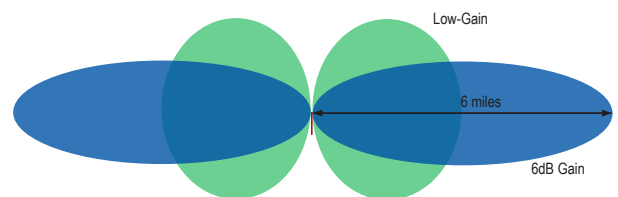

Directional Antennas

A directional (Yagi) antenna focuses the radio signal in one specific direction.

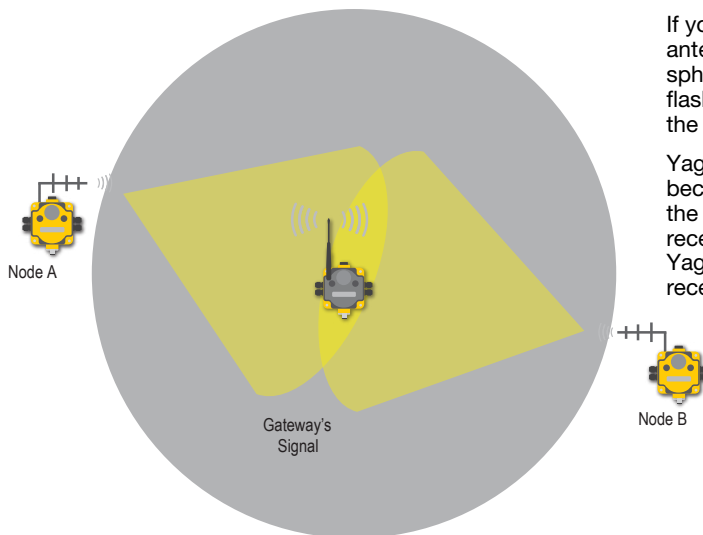

If you compare antenna radiation patterns to light, an omni antenna radiates a radio signal like a light bulb — evenly in a spherical pattern. A directional antenna radiates similar to a flashlight — focusing the signal only in one direction. The higher the gain, the more focused the beam becomes.

Yagi antennas are best used in line-of-sight radio systems because Yagis focus the radio signal in a specific direction. In the following example, the Gateway uses an omni antenna to receive radio signals from multiple directions but the Nodes use Yagi antennas aimed directly at the Gateway to send and receive the radio signal.

High Gain Directional Antennas

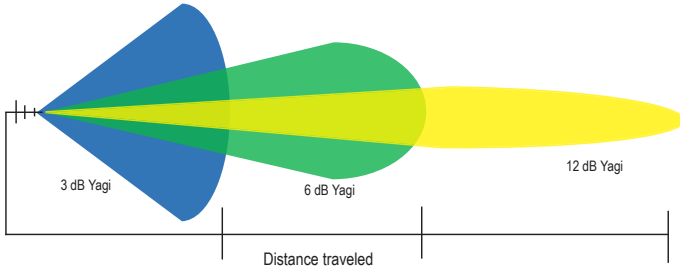

Because Yagi antennas yield narrower radiation patterns, accurately aiming a high-gain Yagi is important when setting up a radio network. The higher the gain of the antenna, the more the signal is focused along a specific plane. High-gain antennas should only be used for line-of-sight applications.

High-gain Yagi antennas are sensitive to mechanical mounting problems like wind, causing the antennas to become misaligned.

Path (Link) Loss Calculations

Path, or link, loss calculations determine the exact capabilities of a radio system by calculating the total gain (or loss) of a radio system.

$$\text{System Total Gain} = \text{Transmitter gain} + \text{Free space loss} + \text{Receiver gain}$$

The transmitter and receiver gains are typically positive numbers while the free space loss is a larger negative number. The total gain for any radio system should be negative. Compare this total gain value to the receiver sensitivity of the Banner Sure Cross® radios listed below.

- 900 MHz: -104 dBm Sensitivity
- 2.4 GHz: -100 dBm Sensitivity

Path loss calculations must include all components of a radio system because any item connected to a radio system has a specific loss associated with it. Common items used within a radio network are cables, connectors, and surge suppressors. Cabling loss is usually measured per foot while losses for connectors and other items are specific to the component. When calculating the total gain of a radio system, include losses from all components of the system in your link budget calculations.

- Surge suppressor: 1 dB estimated loss
- N-type connectors (per pair): 0.5 dB estimated loss
- SMA connector: 0.5 dB estimated loss
- LMR400 coax cable: 3.9 dB per 100 ft (0.039 dB per ft) or 0.128 dB per meter (1.28 dB per 10 meters) estimated loss

Path Loss Calculations for the Transmitter System

To calculate the loss of the transmitter system shown below, include the losses from each connector pair, the surge suppressor, and the cable.

| | Device | Estimated Gain or Loss |
|---|---------------------------|------------------------|
| Radio's Power Output | DX70 or DX80 radio | 21 dBm |
| Gains (+) or Losses (-) | Connector pairs | -1.0 dB |
| | Surge suppressor | -1.0 dB |
| | Cable (50 ft length) | -1.95 dB |
| | Omni antenna ¹ | +8.15 dBi |
| Effective output of radio system | | 25.2 dBm |

¹ Varies based on the antenna. Please refer to the technical specifications for the specific antenna used in the radio system.

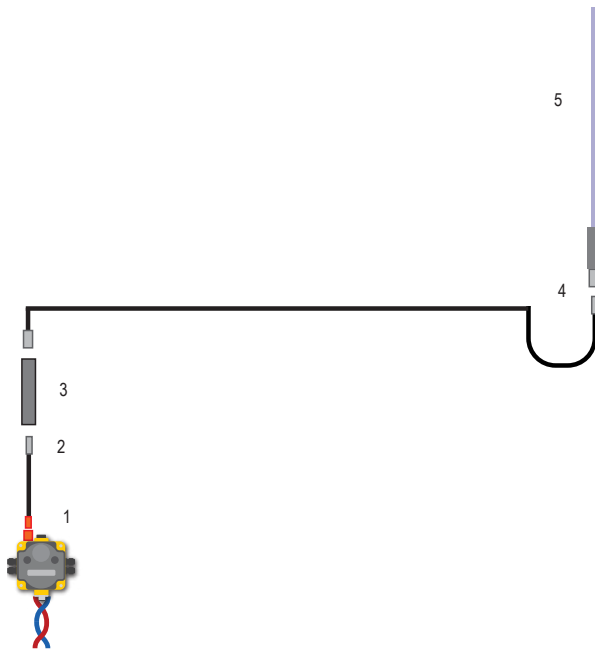

1. RP-SMA connection (-0.5 dB)
2. N-type male connection
3. Surge suppressor (N-type female to N-type male) (-1.0 dB)
4. N-type male connection (cable) to N-type female (antenna) (-0.5 dB)
5. Omni-directional antenna (6 dBd/8.15 dBi)

Losses:

- 0.5 dB per connection
- 1.0 dB per surge suppressor
- 3.9 per 100 feet of cable for LMR400 coax

Path Loss Calculations for Free Space

In addition to losses from cabling, connectors, and surge suppressors, radio signals also experience loss when traveling through the air. The equations for free space loss are:

$$FSL_{900\text{MHz}} = 31.5 + 20 \text{ Log } d \text{ (where } d \text{ is in meters)}$$

$$FSL_{2.4\text{GHz}} = 40 + 20 \text{ Log } d \text{ (where } d \text{ is in meters)}$$

For a 900 MHz radio system transmitting three miles, the free space loss is:

$$FSL_{900\text{MHz}} = 31.5 + 20 \text{ Log } (3 \times 5280/3.28)$$

$$FSL_{900\text{MHz}} = 31.5 + 20 \text{ Log } (4829.27)$$

$$FSL_{900\text{MHz}} = 31.5 + 73.68 = 105.18 \text{ dB}$$

Because this is a loss calculation, free space loss is a negative number.

Path Loss Calculations for the Receiver System

To calculate the link loss of the receiver system shown below, include the losses from each connector pair, the surge suppressor, and the cable.

| | Device | Estimated Gain or Loss |
|---|---------------------------|------------------------|
| Radio's Power Output | DX70 or DX80 radio | N/A |
| Gains (+) or Losses (-) | Connector pairs | -1.0 dB |
| | Surge suppressor | -1.0 dB |
| | Cable (50 ft length) | -1.95 dB |
| | Yagi antenna ² | +8.15 dBi |
| Effective gain of receiving antenna system | | 4.2 dBm |

² Varies based on the antenna. Please refer to the technical specifications for the specific antenna used in the radio system.

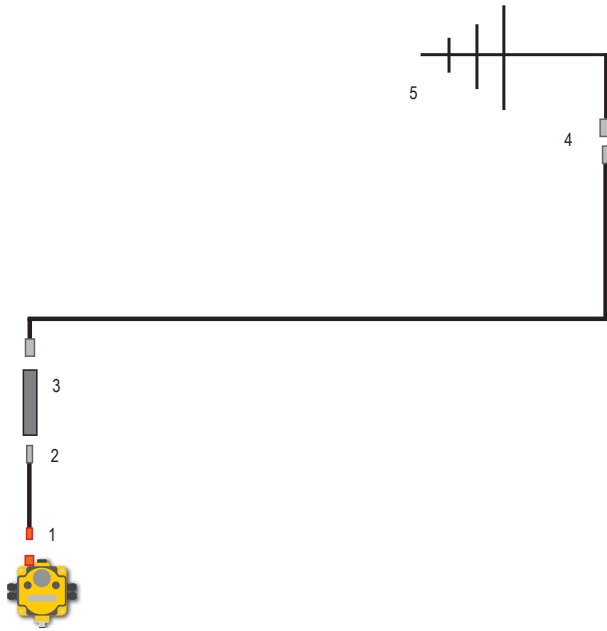

1. RP-SMA connection (-0.5 dB)
2. N-type male connection
3. Surge suppressor (N-type female to N-type male) (-1.0 dB)
4. N-type male (cable) to N-type female (antenna) connection (-0.5 dB)
5. Yagi antenna (6 dBd/8.15 dBi)

Losses:

- 0.5 dB per connection
- 1.0 dB per surge suppressor
- 3.9 per 100 feet of cable for LMR400 coax

Path Loss Calculations for the Complete System

The total losses for the entire system are:

- Effective output of the radio system: 25.20 dBm
- Free space loss: -105.18 dB
- Effective gain of receiving antenna system: 4.20 dBi
- Total received power: -75.78 dBm**

Compare the total received power to the sensitivity of the radio receiver to determine if the signal will be reliably received by subtracting the receive sensitivity of the radio from the total received power: -75.78 dBm - (-104 dBm) = 28.22

When the result is greater than 10 dB, the receiver should reliably receive the radio signal.

Specifications

MultiHop Radio Specifications

Radio Range³

- 900 MHz, 1 Watt: Up to 9.6 km (6 miles)
- 2.4 GHz, 65 mW: Up to 3.2 km (2 miles)

Antenna Minimum Separation Distance

- 900 MHz, 1 Watt: 4.57 m (15 ft)
- 2.4 GHz, 65 mW: 0.3 m (1 ft)

Radio Transmit Power

- 900 MHz, 1 Watt: 30 dBm (1 W) conducted (up to 36 dBm EIRP)
- 2.4 GHz, 65 mW: 18 dBm (65 mW) conducted, less than or equal to 20 dBm (100 mW) EIRP

Spread Spectrum Technology

FHSS (Frequency Hopping Spread Spectrum)

Communication Hardware (MultiHop RS-485)

Interface: 2-wire half-duplex RS-485
 Baud rates: 9.6k, 19.2k (default), or 38.4k via DIP switches; 1200 and 2400 via the MultiHop Configuration Tool
 Data format: 8 data bits, no parity, 1 stop bit

900 MHz Compliance (1 Watt)

FCC ID UE3RM1809: This device complies with FCC Part 15, Subpart C, 15.247
 IC: 7044A-RM1809

2.4 GHz Compliance (MultiHop)

FCC ID UE300DX80-2400 - This device complies with FCC Part 15, Subpart C, 15.247
 ETSI EN 300 328: V1.8.1 (2012-04)
 IC: 7044A-DX8024

Antenna Connection

Ext. Reverse Polarity SMA, 50 Ohms
 Max Tightening Torque: 0.45 N-m (4 lbf-in)

Packet Size (MultiHop)

900 MHz: 175 bytes (85 Modbus registers)
 2.4 GHz: 75 bytes (37 Modbus registers)

Intercharacter Timing (MultiHop)

3.5 milliseconds

³ Radio range is with the 2 dB antenna that ships with the product. High-gain antennas are available, but the range depends on the environment and line of sight. Always verify your wireless network's range by performing a Site Survey.

Performance Radio Specifications

Radio Range[‡]

900 MHz, 1 Watt: Up to 9.6 km (6 miles)
2.4 GHz, 65 mW: Up to 3.2 km (2 miles)

Antenna Minimum Separation Distance

900 MHz, 1 Watt: 4.57 m (15 ft)
2.4 GHz, 65 mW: 0.3 m (1 ft)

Radio Transmit Power

900 MHz, 1 Watt: 30 dBm (1 W) conducted (up to 36 dBm EIRP)
2.4 GHz, 65 mW: 18 dBm (65 mW) conducted, less than or equal to 20 dBm (100 mW) EIRP

Spread Spectrum Technology

FHSS (Frequency Hopping Spread Spectrum)

900 MHz Compliance (1 Watt)

FCC ID UE3RM1809: This device complies with FCC Part 15, Subpart C, 15.247
IC: 7044A-RM1809

2.4 GHz Compliance

FCC ID UE300DX80-2400 - This device complies with FCC Part 15, Subpart C, 15.247
ETSI EN 300 328: V1.8.1 (2012-06)
IC: 7044A-DX8024

Antenna Connection

Ext. Reverse Polarity SMA, 50 Ohms
Max Tightening Torque: 0.45 N-m (4 lbf-in)

[‡] Radio range is with the 2 dB antenna that ships with the product. High-gain antennas are available, but the range depends on the environment and line of sight. Always verify your wireless network's range by performing a Site Survey.