

Sure Cross® Performance Condition Monitoring Node (Vibration and Current Monitoring)



Datasheet

The Sure Cross® wireless system is a radio frequency network with integrated I/O that operates in most environments to eliminate the need for wiring runs. The Sure Cross Performance Series Condition Monitoring Node (CM1) combines a pre-wired M12 connector for use with any Banner 1-wire serial VT1 vibration sensor (sold separately) and a pre-wired one-meter twisted pair cable for use with a supplied current transformer ¹ with the reliable, field-proven Sure Cross wireless architecture into one, easy-to-deploy package.

This proven wireless solution makes condition monitoring simple by measuring vibration and current with a single device. All configuration is done using the internal DIP switches or customized with Banner's DX80 Performance Configuration Software.



Benefits

- Deliver factory automation and IIoT solutions for a range of applications requiring vibration and current monitoring including:
 - Motor brushes
 - Motor windings
 - Motor load
 - Compressor failure
 - Energy use
 - Remote lighting use
 - On/off state
- **Eliminate control wires**—The Sure Cross wireless system is a radio frequency network with integrated I/O and internal battery that removes the need for power and control wires
- **Reduce complexity**—Machine or process reconfiguration made easier; great for retrofit applications
- **Deploy easily**—Simplify installation on existing equipment to enable deployment in remote and hard-to-access locations where implementing a wired solution would be difficult, impractical, or not cost-effective

- The current transformer input takes a high voltage current input and produces a proportional low voltage, low current signal for measuring and monitoring.
- Selectable transmit power levels of 250 mW or 1 Watt for 900 MHz models and 65 mW for 2.4 GHz models
- DIP switches for user configuration
- Frequency Hopping Spread Spectrum (FHSS) technology ensures reliable data delivery
- Transceivers provide bidirectional communication between the Gateway and Node, including fully acknowledged data transmission
- Diagnostics allow user-defined output settings in the unlikely event of lost radio signal

Models

Model	Frequency	Inputs and Outputs
DX80N9X1W-CM1L	900 MHz ISM Band	Pre-wired M12 connector for use with any 1-wire serial vibration sensor (sold separately).
DX80N2X1W-CM1L	2.4 GHz ISM Band	Pre-wired one meter twisted pair cable reports true RMS Current (20 A and 150 A current transformers included with Node; model and frequency are DIP switch selectable)

To order an integrated battery model without the battery, add a **-NB** to the model number. If you purchase a model without the battery, Banner Engineering recommends lithium D cell battery **BWA-BATT-001**.

Configuration Instructions

Setting Up Your Wireless Network

To set up and install your wireless network, follow these steps.

For complete instructions, including binding, configuration, installation, weatherproofing, device menu maps, troubleshooting, and a list of accessories, refer to Sure Cross® Wireless I/O Network Instruction Manual (p/n [132607](#))

1. Disconnect the power from your Sure Cross devices.
2. Configure the DIP switches of all devices. DIP switch configurations are always listed in the product's datasheet.
3. If your device has I/O, connect the sensors to the Sure Cross devices. Available I/O is always listed in the product's datasheet. If your device does not have I/O, skip this step.
4. Refer to the wiring diagrams to apply power to all devices.

¹ The Node includes two split core current transformers: 20 A and 150 A. For more information, see [Sensors](#) on page 9.



- For housed models, the Gateway's LED 1 is solid green and the Node's LED 2 flashes red to indicate there is no radio link to the Gateway.
 - For board-level models, the Gateway's LED is solid green and the Node's LED flashes red to indicate there is no radio link to the Gateway.
5. Form the wireless network by binding the Nodes to the Gateway.
 6. Observe the LED behavior to verify the devices are communicating with each other.
 - For housed models, the Gateway's LED 1 is solid green and the Node's LED 1 flashes green to indicate it is communicating with the Gateway.
 - For board-level models, the Gateway's LED is solid green and the Node's LED flashes green to indicate it is communicating with the Gateway.
 7. Configure any I/O points to use the sensors connected to the Sure Cross devices.
 8. Conduct a site survey between the Gateway and Nodes.
 9. Install your wireless sensor network components.

Configure the DIP Switches

Before changing DIP switch positions, disconnect the power. Any changes made to the DIP switches are not recognized until after power is cycled to the device.

For devices powered by batteries integrated into the housing, triple-click button 2, then double-click button 2 to reset the device without removing the battery.

For parameters not set using the DIP switches, use the configuration software to make configuration changes. For parameters set using the DIP switches, the DIP switch positions override any changes made using the configuration software.

Access the Internal DIP Switches

Follow these steps to access the internal DIP switches.

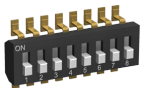

1. Unscrew the four screws that mount the cover to the bottom housing.
2. Remove the cover from the housing without damaging the ribbon cable or the pins the cable plugs into.
3. Gently unplug the ribbon cable from the board mounted into the bottom housing. Skip this step if there is no ribbon cable (integrated battery models) or the ribbon cable is glued down (C housing models).
4. Remove the black cover plate from the bottom of the device's cover. The DIP switches are located behind the rotary dials.
5. Make the necessary changes to the DIP switches.
6. Place the black cover plate back into position and gently push into place.
7. If necessary, plug the ribbon cable in after verifying that the blocked hole lines up with the missing pin.
8. Mount the cover back onto the housing.

DIP Switch Settings

Table 1: DIP switch settings

Description	Switch #							
	1	2	3	4	5	6	7	8
Transmit power level: 1 Watt (30 dBm)	OFF*							
Transmit power level: 250 mW	ON							
Default I/O configuration		OFF*	OFF*	OFF*				
I/O configuration 1		OFF	OFF	ON				
I/O configuration 2		OFF	ON	OFF				
I/O configuration 3		OFF	ON	ON				
I/O configuration 4		ON	OFF	OFF				
I/O configuration 5		ON	OFF	ON				
Reserved		ON	ON	OFF				
User (software) configured (use the Sensor Configuration Software to pre-configure the vibration sensor)		ON	ON	ON				
Mains frequency (for CT) 60 Hz					OFF*			
Mains frequency (for CT) 50 Hz					ON			
Sample/report rate: User configured (5 minute rate for vibration sensor, 1 minute rate for ac current transformer is default)						OFF*		

Description	Switch #							
	1	2	3	4	5	6	7	8
Sample/report rate: 2.5 minute rate for vibration sensor, 30 second rate for ac current transformer						ON		
English units (velocity = in/sec)							OFF*	
Metric units (velocity = mm/s)							ON	
AC current transformer is 20 A model								OFF*
AC current transformer is 150 A model								ON

Mains Frequency

The nominal frequency of the oscillations of alternating current from a power station/power supply; also known as utility frequency.

In general this will be 60 Hz for the North America and parts of Central and South America and Asia. Europe, Australia, parts of Africa, South America, Central America and Asia use a 50 Hz Mains frequency.

Sample/Report Rates

The sample interval, or rate, defines how often the Sure Cross device samples the input. For battery-powered applications, setting a slower rate extends the battery life. The report rate defines how often the Node communicates the I/O status to the Gateway. For battery-powered applications, setting the report rate to a slower rate extends the battery life.

Transmit Power Level

The 900 MHz radios transmit at 1 Watt (30 dBm) or 250 mW (24 dBm). The 250 mW mode reduces the radio's range but improves the battery life in short range applications. For 2.4 GHz models, this DIP switch is disabled. The transmit power for 2.4 GHz is fixed at about 65 mW EIRP (18 dBm).

User or DIP Switch Configured

User (Software) Configured mode, use the DX80 Performance Configuration Software or a Modbus command to change the device parameters. DIP switch position 6 is ignored. In DIP Switch Configured mode, use the DIP switches to configure the parameters listed in the table.

Table 2: I/O configurations set by DIP switches 2 through 4

I/O Configurations Set by DIP Switches 2 through 4							
Input Register		Default I/O	I/O Configuration 1	I/O Configuration 2	I/O Configuration 3	I/O Configuration 4	I/O Configuration 5
1	Z-Axis	RMS Velocity (in/s)*	RMS Velocity (in/s) *	High-Frequency RMS Acceleration (g)	RMS Velocity (in/s) *	Full Bandwidth RMS Acceleration (g)	RMS Velocity (in/s) *
2		High-Frequency RMS Acceleration (g)	Peak Acceleration (g)	Peak Acceleration (g)	Peak Velocity Component Frequency (Hz)	Full Bandwidth Peak Acceleration (g)	Full Bandwidth RMS Acceleration (g)
3	-	Temperature (°F) *	Temperature (°F) *	Temperature (°F) *	Temperature (°F) *	Temperature (°F) *	Temperature (°F) *
4	-	RMS Current (A)	RMS Current (A)	RMS Current (A)	RMS Current (A)	RMS Current (A)	RMS Current (A)
5	X-Axis	RMS Velocity (in/s) *	RMS Velocity (in/s) *	High-Frequency RMS Acceleration (g)	RMS Velocity (in/s) *	Full Bandwidth RMS Acceleration (g)	RMS Velocity (in/s) *
6		High-Frequency RMS Acceleration (g)	Peak Acceleration (g)	Peak Acceleration (g)	Peak Velocity Component Frequency (Hz)	Full Bandwidth Peak Acceleration (g)	Full Bandwidth RMS Acceleration (g)

* If DIP switch 7 is on, all in/s units change to mm/s, all degrees F change to degrees C. DIP switch 7 will only change units using the DIP switch I/O configurations, not with any user configuration.

To interpret the holding register representation of the current transformer (CT) in amperes, divide the register value by 100.

To interpret the holding register representation of a vibration sensor, refer to the [QM30VT1 datasheet](#) (p/n 212568) for specific register I/O ranges, how to scale the data appropriately, and measurement units.

Wire for Power and I/O

The CM1L Node comes pre-wired and pre-configured to work with the supplied current transformers. No additional wiring is required. The following wiring diagram is for reference only. Do not re-wire the Node.

Table 3: Wiring for the CM1L Node

Input Configuration	Jumper Setting	VT Wire	CT Wire	Wiring Terminals	Description
Reserved	J3 set to 5			1	Reserved
1-wire serial input for VT1	J3 set to 8	gray		1	1-wire serial input for VT1
		white and blue		2	Ground
Switch power 1		brown		3	Power for VT1
Reserved	J1 (not used)			4	
			blue	5	Ground
CT Input	J2 set to 3		brown	6	CT Input
Reserved	J2 set to 4			6	Reserved

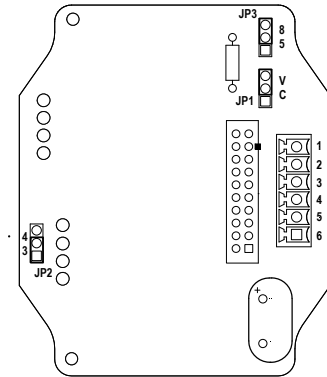

Table 4: VT1 wiring to Node

Table 5: 5-pin M12 connector (male) wiring

5-pin M12 Connector (Male)	Pin	Wire Color	Sensor Connection
	1	Brown	Power IN (+), 3.6 to 5.5 V DC
	2	White	1-Wire serial device select (sinking input to sensing device)
	3	Blue	Ground (-)
	4	Black	Not used/reserved
	5	Gray	1-Wire serial communications

Wire the Current Transformer

For more information on wiring and installing the current transformer, refer to the Split Core Current Transformer datasheet (p/n 212463).

Figure 1. Current transformer wiring

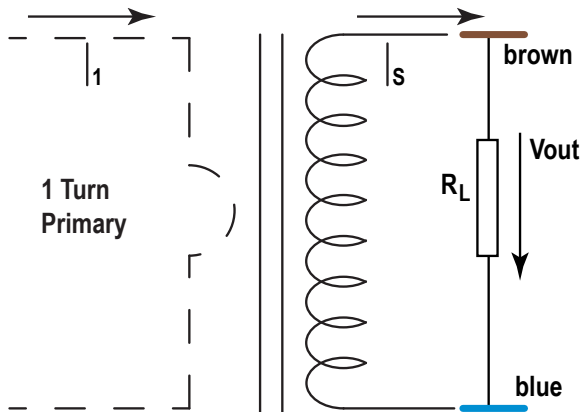
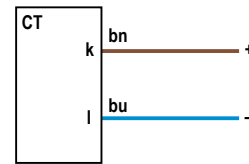

Figure 2. Current transformer wiring to Node



Wire Color	Description
brown	Input from CT (k)
blue	CT ground (l)

Install or Replace the Battery for a DX80 Integrated Battery Model

To install or replace the 3.6 V lithium "D" cell battery in any model with a battery integrated into the housing, follow these steps.

1. Remove the four screws mounting the face plate to the housing and remove the face plate.
2. Remove the discharged battery.
3. Install the new battery, verifying the battery's positive and negative terminals align to the positive and negative terminals of the battery holder mounted within the case.

4. After installing the battery, allow up to 60 seconds for the device to power up.
5. Properly dispose of used batteries according to local regulations by taking it to a hazardous waste collection site, an e-waste disposal center, or other facility qualified to accept lithium batteries.

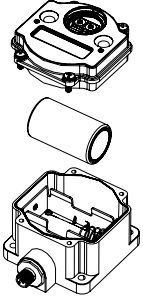

CAUTION: There is a risk of explosion if the battery is replaced incorrectly.

As with all batteries, these are a fire, explosion, and severe burn hazard. Do not burn or expose them to high temperatures. Do not recharge, crush, disassemble, or expose the contents to water.

For non-hazardous locations, the replacement battery is model **BWA-BATT-011**. For non-hazardous or hazardous locations, the replacement battery is Xeno model XL-205F, Banner model **BWA-BATT-001**. For pricing and availability, contact Banner Engineering.

Bind a DX80 Node to a Gateway and Assign the Node Address

Follow these instructions to bind a Node that does not have rotary dials to any Gateway.

Binding Nodes to a Gateway ensures the Nodes only exchange data with the Gateway they are bound to. For a more detailed definition of binding mode, refer to the Sure Cross Performance DX80 Wireless I/O Networks instruction manual (p/n 132607).

1. Apply power to the Gateway and Nodes.
2. On the Gateway: Enter binding mode.
 - If you have a two-button Gateway, triple-click button 2
 - If you have a one-button Gateway, triple-click the button

Figure 3. Two-button Gateway



Figure 4. One-button Gateway

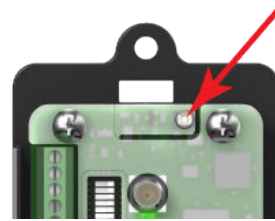

- The LEDs flash alternately when the Gateway is in binding mode. Any Node entering binding mode will bind to this Gateway.
3. Using the Gateway's rotary dials, select the Node address to assign to the Node. Use the left rotary dial for the left digit and the right rotary dial for the right digit. For example, to assign your Node to address 10, set the left dial to 1 and the right dial to 0. (Address 00 is reserved for the Gateway. Nodes assigned to 00 will not bind to a Gateway.)
 4. On the Node: Enter binding mode.
 - If you have a two-button Node, triple-click button 2.
 - If you have a one-button Node, triple-click the button.

The Node enters binding mode and locates the Gateway in binding mode.

For two LED models, the red LEDs flash alternately. After binding is complete, both LEDs are both solid red for a few seconds.

For one-LED models, the red and green LED flashes alternately while the Node searches for the Gateway. After binding is complete, the LED is red and green for four seconds (looks amber), then the red and green flash simultaneously (looks amber) four times.

The Node automatically exits binding mode, cycles its power, then enters RUN mode.

5. Repeat these steps for all Nodes that will communicate to this Gateway.
6. On the Gateway: Exit binding mode.
 - If you have a two-button Gateway, single-click either button.
 - If you have a one-button Gateway, single-click the button.

Bind a DX80 Node to a DXM and Assign the Node Address

Binding Nodes to a Gateway ensures the Nodes only exchange data with the Gateway they are bound to. After a Gateway enters binding mode, the Gateway automatically generates and transmits a unique extended addressing (XADR), or binding, code to all Nodes within range that are also in binding mode. The extended addressing (binding) code defines the network, and all radios within a network must use the same code.

1. Apply power to all the devices.

Separate radios by two meters when running the binding procedure. Put only one DXM Gateway into binding mode at a time to prevent binding to the wrong Gateway.

2. Enter binding mode on the DXM radio:
 - a) Use the arrow keys to select the **ISM Radio** menu on the LCD and press **ENTER**.
 - b) Highlight the **Binding** menu and press **ENTER**.
3. Assign the Node address to the Node.
 - For Nodes without rotary dials: Use the DXM arrow keys to select the Node address to assign to the DX80 Node about to enter binding mode. The DXM assigns this Node address to the next Node that enters binding mode. Only bind one Node at a time.
 - For Nodes with rotary dials: Use the Node's rotary dials to assign a valid decimal Node Address (between 01 and 47). The left rotary dial represents the tens digit (0 through 4) and the right dial represents the ones digit (0 through 9) of the Node Address. You can leave the DXM "Bind to" address set to 1 because the Node's rotary dials will override that setting.
4. Start binding mode on the DXM radio by pressing **ENTER** on the DXM radio.
5. Enter binding mode on the DX80 Node.
 - For housed radios, triple-click button 2.
 - For board-level radios, triple-click the button.
 - For Nodes without buttons, refer to the Node's datasheet for instructions on entering binding mode.

The left and right LEDs flash alternately and the Node searches for a Gateway in binding mode. After the Node binds, the LEDs stay solid momentarily, then they flash together four times. The Node automatically exits binding mode and reboots.
6. Label the Node with the assigned address number for future reference.
7. Press **BACK** on the DXM to exit binding mode for that specific Node address.

The Node LEDs continue to flash red until the DXM exits binding mode with that Node address.
8. Repeat these steps for as many DX80 Nodes as are needed for your network.
9. When you are finished binding, press **BACK** on the DXM until you return to the main menu.

LED Behavior for the Nodes

Nodes do not sample inputs until they are communicating with the Gateway.

The radios and antennas must be a minimum distance apart to function properly. Recommended minimum distances are:

- 900 MHz 150 mW and 250 mW radios: 6 feet
- 900 MHz 1 Watt radios: 15 feet
- 2.4 GHz 65 mW radios: 1 foot

Table 6: LED behavior for the Nodes

LED 1	LED 2	Node Status
Flashing green		Radio Link Ok
Flashing red	Flashing red	Device Error
	Flashing red, 1 per 3 sec	No Radio Link

Sure Cross® DX80 Performance Configuration Software

The configuration software offers an easy way to link I/O points in your wireless network, view I/O register values, and set system communication parameters when a host system is not part of the wireless network. The software runs on any computer with the Windows Vista, Windows 7, Windows 8, or Windows 10 operating system.

Figure 5. Device Configuration screen



Use a USB to RS-485 adapter cable to connect a standalone DX80 Gateway to the computer. For DXM Controllers with an internal DX80 radio, connect a computer to the DXM Controller using the supplied USB or Ethernet connection. Download the most recent revisions of the configuration software from Banner Engineering's website: <https://www.bannerengineering.com/us/en/products/wireless-sensor-networks/reference-library/software.html>.

The USB to RS-485 adapter cable is not required for the DXM Controller. For standalone DX80 Gateway devices use:

- USB to RS-485 adapter cable model **BWA-UCT-900** for 1 Watt radios
- USB to RS-485 adapter cable model **BWA-HW-006** for all other radios

Holding Registers

Table 7: Holding registers for the CM1L Node

Modbus Registers		EIP Registers		I/O Type	I/O Range		Holding Register Representation (Dec)		
Gateway	Node	Node			Min.	Max.	Min.	Max.	
1	1 + (Node# × 16)	0 + (Node# × 8)	Instance 100 / N7	Vibration Sensor Input Register 1					
2	2 + (Node# × 16)	1 + (Node# × 8)		Vibration Sensor Input Register 2					
3	3 + (Node# × 16)	2 + (Node# × 8)		Vibration Sensor Input Register 3					
4	4 + (Node# × 16)	3 + (Node# × 8)		Current Transformer Input Register					
5	5 + (Node# × 16)	4 + (Node# × 8)		Vibration Sensor Input Register 5					
6	6 + (Node# × 16)	5 + (Node# × 8)		Vibration Sensor Input Register 6					
7	7 + (Node# × 16)	6 + (Node# × 8)		Reserved					
8	8 + (Node# × 16)	7 + (Node# × 8)		Device Message					
9	9 + (Node# × 16)	0 + (Node# × 8)	Instance 112 / N14						
	...								
15	15 + (Node# × 16)	6 + (Node# × 8)		Control Message					
16	16 + (Node# × 16)	7 + (Node# × 8)		Reserved					

To interpret the holding register representation of the current transformer (CT) in amperes, divide the register value by 100.

To interpret the holding register representation of a vibration sensor, refer to the [QM30VT1 datasheet](#) (p/n 212568) for specific register I/O ranges, how to scale the data appropriately, and measurement units.

To use a current transformer other than those provided, ensure the CT matches the 333 mV output characteristics of the CTs provided with the Condition Monitoring Node. For more information, see [CM1L Node Specifications](#) on page 8. If the custom CT exceeds the 150 A CT, set DIP switch 8 to ON and use a DXM Controller or PLC to multiply the typical 150 A output value in input 4 by the ratio of the custom CT to 150 A. For example: For a 300 A CT, divide input 4 register data by 100 as you would for the 150 A CT, then multiply that value by 2 to scale it to 300 A.

Installing Your Sure Cross® Radios

Please refer to one of these instruction manuals to install your wireless network components.

- Performance Wireless I/O Network Instruction Manual: [132607](#)
- MultiHop Data Radio Instruction Manual: [151317](#)

Storage and Sleep Modes

Storage Mode (applies to battery-powered models only)—While in **storage mode**, the radio does not operate. To put any integrated battery Sure Cross® radio into storage mode, press and hold button 1 for five seconds. To wake the device, press and hold button 1 for five seconds. The radio is in storage mode when the LEDs stop blinking, but in some models, the LCD remains on for an additional minute after the radio enters storage mode. After a device has entered storage mode, you must wait one minute before waking it.

Sleep Mode (applies to both battery and 10–30 V DC powered models)—During normal operation, the Sure Cross radio devices enter **sleep mode** after 15 minutes of operation. The radio continues to function, but the LCD goes blank. To wake the device, press any button.

Specifications

Performance Radio Specifications

Radio Range²

900 MHz, 1 Watt: Up to 9.6 km (6 miles)
2.4 GHz, 65 mW: Up to 3.2 km (2 miles)

Antenna Minimum Separation Distance

900 MHz, 1 Watt: 4.57 m (15 ft)
2.4 GHz, 65 mW: 0.3 m (1 ft)

Radio Transmit Power

900 MHz, 1 Watt: 30 dBm (1 W) conducted (up to 36 dBm EIRP)
2.4 GHz, 65 mW: 18 dBm (65 mW) conducted, less than or equal to 20 dBm (100 mW) EIRP

Spread Spectrum Technology

FHSS (Frequency Hopping Spread Spectrum)

Link Timeout (Performance)

Gateway: Configurable via User Configuration Software
Node: Defined by Gateway

Antenna Connection

Ext. Reverse Polarity SMA, 50 Ohms
Max Tightening Torque: 0.45 N·m (4 lbf·in)

900 MHz Compliance (1 Watt)

Contains FCC ID: UE3RM1809: FCC Part 15, Subpart C, 15.247
Contains IC: 7044A-RM1809
IFT: RCPBARM13-2283



(NOM approval only applies to 900 MHz models)

2.4 GHz Compliance (DX80-2400 Radio Module)

Radio module is indicated by the product label marking
Contains FCC ID: UE300DX80-2400: FCC Part 15, Subpart C, 15.247
Radio Equipment Directive (RED) 2014/53/EU
Contains IC: 7044A-DX8024

ANATEL: 15966-21-04042 Este equipamento não tem direito à proteção contra interferência prejudicial e não pode causar interferência em sistemas devidamente autorizados. Para maiores informações, consulte o site da ANATEL www.gov.br/anatel/pt-br/

2.4 GHz Compliance (SX243 Radio Module)

Radio module is indicated by the product label marking
Contains FCC ID: UE3SX243: FCC Part 15, Subpart C, 15.247
Radio Equipment Directive (RED) 2014/53/EU
Contains IC: 7044A-SX243

Environmental Specifications

Operating Conditions

-40 °C to +85 °C (-40 °F to +185 °F)
95% maximum relative humidity (non-condensing)
Radiated Immunity: 10 V/m (EN 61000-4-3)

Shock and Vibration

All models meet IEC 60068-2-6 and IEC 60068-2-27 testing criteria
Shock: 30G 11 ms duration, half sine wave per IEC 60068-2-27
Vibration: 10 Hz to 55 Hz, 0.5 mm peak-to-peak amplitude per IEC 60068-2-6

Environmental Ratings

IEC IP67; NEMA 6
For installation and waterproofing instructions, go to www.bannerengineering.com and search for the complete instruction manual (p/n 132607)

Operating the devices at the maximum operating conditions for extended periods can shorten the life of the device.

CM1L Node Specifications

Supply Voltage

3.6 V DC (internal battery)

Current Draw at 3.6 V DC

900 MHz, 1 Watt: Approximately 1 mA
900 MHz, 250 mW: Approximately 0.5 mA
2.4 GHz, 65 mW: Approximately 0.3 mA

CT20A and CT150A Current Transformer

Electrical:

Rated input: 0–20 A (CT20A) or 0–150 A (CT150A)
Rated Output: 0.333 V (AC)
Ratio: $\leq \pm 1.0\%$
Phase angle: $\leq \pm 60$ min
Dielectric Strength: 2.5 kV/1 mA/1 min
Insulation Resistance: DC500 V/100 MOhm min

Mechanical:

Case: PA / UL94-V0
Bobbin: PBT
Core: Silicon Steel
-25 °C to +75 °C (-13 °F to +167 °F)
 $\leq 85\%$ maximum relative humidity (non-condensing)

For more information, refer to the [Split Core Current Transformer](#) datasheet (p/n 212463)

Housing

Polycarbonate housing; polyester labels; EDPM rubber cover gasket; nitrile rubber, non-sulphur cured button covers
Weight: 0.30 kg (0.65 lbs)
Mounting: #10 or M5 (SS M5 hardware included)
Max. Tightening Torque: 0.56 N·m (5 lbf·in)

Interface

Two bi-color LED indicators; Two buttons;

Wiring Access

Pre-wired for vibration sensor
Pre-wired cable for current transducer

Certifications



Banner Engineering Europe
Park Lane, Culliganlaan 2F
bus 3, 1831 Diegem,
BELGIUM

(CE/UKCA approval only applies to 2.4 GHz models)

Turck Banner LTD Blenheim
House, Blenheim Court,
Wickford, Essex SS11 8YT,
Great Britain

² Radio range is with the 2 dB antenna that ships with the product. High-gain antennas are available, but the range depends on the environment and line of sight. Always verify your wireless network's range by performing a Site Survey.

Accessories

Mounting Brackets

BWA-BK-020

- Includes two 80-lb pull rare-earth magnet mounts and two #10-32 × 1 inch screw mounts
- Used on multiple mounting brackets
- 31.75 mm (1.25 inch) diameter

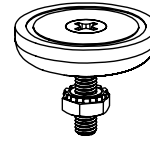

Sensors

BWA-CURRENT-TRANSFORMER-20A Split-Core Current Transformer

- 5–20 A Input
- 0.333 V Output
- Datasheet p/n [212463](#)

A = 41 mm; B = 24 mm; C = 26.5 mm

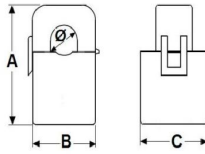

BWA-CURRENT-TRANSFORMER-150A Split-Core Current Transformer

- 5–150 A Input
- 0.333 V Output
- Datasheet p/n [212463](#)

A = 45.5 mm; B = 29 mm; C = 31.5 mm

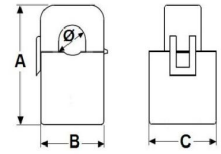

QM30VT1 Vibration and Temperature Sensor

- Aluminum housing
- 2.09 m (6.85 ft) cable with a 5-pin M12 male quick disconnect (QD)
- Datasheet: [212568](#)

QM30VT1-QP Vibration and Temperature Sensor

- Aluminum housing
- 150 mm (6 in) cable with a 5-pin M12 male quick disconnect (QD)
- Datasheet: [212568](#)

QM30VT1-SS Vibration and Temperature Sensor

- Stainless steel housing
- 2.09 m (6.85 ft) cable with a 5-pin M12 male quick disconnect (QD)
- Datasheet: [212568](#)

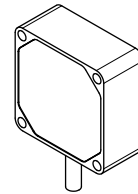

Replacement Batteries

BWA-BATT-001

- 3.6 V Lithium D cell for hazardous or non-hazardous locations
- One battery



Warnings

Install and properly ground a qualified surge suppressor when installing a remote antenna system. Remote antenna configurations installed without surge suppressors invalidate the manufacturer's warranty. Keep the ground wire as short as possible and make all ground connections to a single-point ground system to ensure no ground loops are created. No surge suppressor can absorb all lightning strikes; do not touch the Sure Cross® device or any equipment connected to the Sure Cross device during a thunderstorm.

Exporting Sure Cross® Radios. It is our intent to fully comply with all national and regional regulations regarding radio frequency emissions. **Customers who want to re-export this product to a country other than that to which it was sold must ensure the device is approved in the destination country.** The Sure Cross wireless products were certified for use in these countries using the antenna that ships with the product. When using other antennas, verify you are not exceeding the transmit power levels allowed by local governing agencies. This device has been designed to operate with the antennas listed on Banner Engineering's website and having a maximum gain of 9 dBm. Antennas not included in this list or having a gain greater than 9 dBm are strictly prohibited for use with this device. The required antenna impedance is 50 ohms. To reduce potential radio interference to other users, the antenna type and its gain should be so chosen such that the equivalent isotropically radiated power (EIRP) is not more than that permitted for successful communication. Consult with Banner Engineering Corp. if the destination country is not on this list.



Important: Please download the complete Performance Gateway or Node technical documentation, available in multiple languages, from www.bannerengineering.com for details on the proper use, applications, Warnings, and installation instructions of this device.



Important: Por favor descargue desde www.bannerengineering.com toda la documentación técnica de los Performance Gateway or Node, disponibles en múltiples idiomas, para detalles del uso adecuado, aplicaciones, advertencias, y las instrucciones de instalación de estos dispositivos.



Important: Veuillez télécharger la documentation technique complète des Performance Gateway or Node sur notre site www.bannerengineering.com pour les détails sur leur utilisation correcte, les applications, les notes de sécurité et les instructions de montage.



WARNING:

- **Do not use this device for personnel protection**
- Using this device for personnel protection could result in serious injury or death.
- This device does not include the self-checking redundant circuitry necessary to allow its use in personnel safety applications. A device failure or malfunction can cause either an energized (on) or de-energized (off) output condition.



Important:

- **Never operate a 1 Watt radio without connecting an antenna**
- Operating 1 Watt radios without an antenna connected will damage the radio circuitry.
- To avoid damaging the radio circuitry, never apply power to a Sure Cross® Performance or Sure Cross MultiHop (1 Watt) radio without an antenna connected.



Important:

- **Electrostatic discharge (ESD) sensitive device**
- ESD can damage the device. Damage from inappropriate handling is not covered by warranty.
- Use proper handling procedures to prevent ESD damage. Proper handling procedures include leaving devices in their anti-static packaging until ready for use; wearing anti-static wrist straps; and assembling units on a grounded, static-dissipative surface.

Banner Engineering Corp. Limited Warranty

Banner Engineering Corp. warrants its products to be free from defects in material and workmanship for one year following the date of shipment. Banner Engineering Corp. will repair or replace, free of charge, any product of its manufacture which, at the time it is returned to the factory, is found to have been defective during the warranty period. This warranty does not cover damage or liability for misuse, abuse, or the improper application or installation of the Banner product.

THIS LIMITED WARRANTY IS EXCLUSIVE AND IN LIEU OF ALL OTHER WARRANTIES WHETHER EXPRESS OR IMPLIED (INCLUDING, WITHOUT LIMITATION, ANY WARRANTY OF MERCHANTABILITY OR FITNESS FOR A PARTICULAR PURPOSE), AND WHETHER ARISING UNDER COURSE OF PERFORMANCE, COURSE OF DEALING OR TRADE USAGE.

This Warranty is exclusive and limited to repair or, at the discretion of Banner Engineering Corp., replacement. **IN NO EVENT SHALL BANNER ENGINEERING CORP. BE LIABLE TO BUYER OR ANY OTHER PERSON OR ENTITY FOR ANY EXTRA COSTS, EXPENSES, LOSSES, LOSS OF PROFITS, OR ANY INCIDENTAL, CONSEQUENTIAL OR SPECIAL DAMAGES RESULTING FROM ANY PRODUCT DEFECT OR FROM THE USE OR INABILITY TO USE THE PRODUCT, WHETHER ARISING IN CONTRACT OR WARRANTY, STATUTE, TORT, STRICT LIABILITY, NEGLIGENCE, OR OTHERWISE.**

Banner Engineering Corp. reserves the right to change, modify or improve the design of the product without assuming any obligations or liabilities relating to any product previously manufactured by Banner Engineering Corp. Any misuse, abuse, or improper application or installation of this product or use of the product for personal protection applications when the product is identified as not intended for such purposes will void the product warranty. Any modifications to this product without prior express approval by Banner Engineering Corp will void the product warranties. All specifications published in this document are subject to change; Banner reserves the right to modify product specifications or update documentation at any time. Specifications and product information in English supersede that which is provided in any other language. For the most recent version of any documentation, refer to: www.bannerengineering.com.

For patent information, see www.bannerengineering.com/patents.

Notas Adicionales

Información México: La operación de este equipo está sujeta a las siguientes dos condiciones: 1) es posible que este equipo o dispositivo no cause interferencia perjudicial y 2) este equipo debe aceptar cualquier interferencia, incluyendo la que pueda causar su operación no deseada.

Banner es una marca registrada de Banner Engineering Corp. y podrán ser utilizadas de manera indistinta para referirse al fabricante. "Este equipo ha sido diseñado para operar con las antenas tipo Omnidireccional para una ganancia máxima de antena de 6 dBd y Yagi para una ganancia máxima de antena 10 dBd que en seguida se enlistan. También se incluyen aquellas con aprobación ATEX tipo Omnidireccional siempre que no excedan una ganancia máxima de antena de 6dBd. El uso con este equipo de antenas no incluidas en esta lista o que tengan una ganancia mayor que 6 dBd en tipo omnidireccional y 10 dBd en tipo Yagi, quedan prohibidas. La impedancia requerida de la antena es de 50 ohms."

Antenas SMA	Modelo	Antenas Tipo-N	Modelo
Antena, Omni 902-928 MHz, 2 dBd, junta de caucho, RP-SMA Macho	BWA-902-C	Antena, Omni 902-928 MHz, 6 dBd, fibra de vidrio, 1800mm, N Hembra	BWA-906-A
Antena, Omni 902-928 MHz, 5 dBd, junta de caucho, RP-SMA Macho	BWA-905-C	Antena, Yagi, 900 MHz, 10 dBd, N Hembra	BWA-9Y10-A

Mexican Importer

Banner Engineering de México, S. de R.L. de C.V.
David Alfaro Siqueiros 103 Piso 2 Valle oriente
San Pedro Garza Garcia Nuevo León, C. P. 66269
81 8363.2714

ANATEL

Modelo (Model): DX80-2400—Este equipamento não tem direito à proteção contra interferência prejudicial e não pode causar interferência em sistemas devidamente autorizados. Para maiores informações, consulte o site da ANATEL www.gov.br/anatel/pt-br/

