

Features

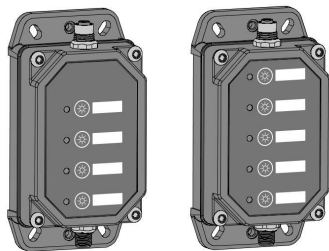

- Rugged, cost-effective, and easy-to-install Andon Control Box
- Integral 5 capacitive touch button controller with programmable LEDs and discrete outputs
- Programmable using Banner's Pro Editor software and Pro Converter Cable
- Two M12 connectors for added Andon application flexibility and easy installation
- Five discrete outputs available to pass up to a total of 4 amps

Models

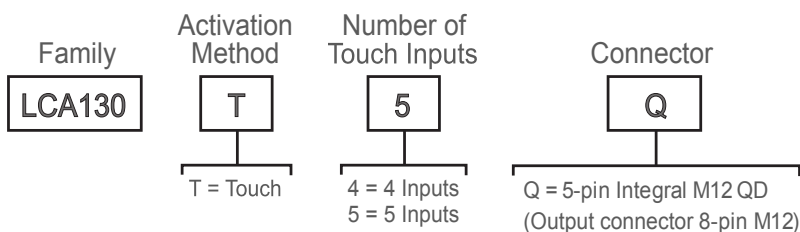

Switch Diagram

Tap or press-to-hold one or more of the buttons to activate a programmed color and animation function.

5-Button Switch Control	Output Pinout	Pinout Key
		Pin 1 = Button 3 Pin 2 = Button 4 Pin 3 = Not used Pin 4 = Button 1 Pin 5 = Button 2 Pin 6 = Button 5 Pin 7 = DC common Pin 8 = Not used
4-Button Switch Control	Output Pinout	Pinout Key
		Pin 1 = Button 2 Pin 2 = Button 3 Pin 3 = DC common Pin 4 = Button 1 Pin 5 = Button 4

Specifications

Supply Voltage and Current

18 V DC to 30 V DC

50 mA maximum current at 18 V DC (exclusive of load)

Supply Protection Circuitry

Protected against transient voltages



Response Time

Power-Up Delay: 500 milliseconds maximum
 Input Response: 40 milliseconds maximum
 Output Response: 300 milliseconds maximum

Output Rating

4A maximum load (combined or on a single wire)

Input

PNP power only

Connections

Integral 5-pin and 8-pin M12 male quick-disconnect connectors
 Models with a quick disconnect require a mating cordset

Construction

Polycarbonate

Vibration and Mechanical Shock

Meets IEC 60068-2-6 requirements (Vibration: 10 Hz to 55 Hz, 0.5 mm amplitude, 5 minutes sweep, 30 minutes dwell)
 Meets IEC 60068-2-27 requirements (Shock: 15G 11 ms duration, half sine wave)

Pro Editor Configuration

- Connection to Pro Editor software enables control of:
- **Animation:** Off, Steady, Flash, Two Color Flash
 - **Color:** Green, Red, Yellow, Blue, Cyan, Magenta, Amber, Rose, Lime Green, Orange, Sky Blue, Violet, Spring Green
 - **Intensity:** Off, Low, Medium, High
 - **Speed:** Slow, Standard, Fast
 - **Pattern:** Normal, Strobe, 3-Pulse, SOS, Random

Pro Converter Cable required to interface between PC and indicator, see Accessories

Operating Conditions

-40 °C to +50 °C (-40 °F to +122 °F)
 95% at +50 °C maximum relative humidity (non-condensing)

Environmental Rating

IP65

Required Overcurrent Protection



WARNING: Electrical connections must be made by qualified personnel in accordance with local and national electrical codes and regulations.

Overcurrent protection is required to be provided by end product application per the supplied table.

Overcurrent protection may be provided with external fusing or via Current Limiting, Class 2 Power Supply.

Supply wiring leads < 24 AWG shall not be spliced.

For additional product support, go to www.bannerengineering.com.

Supply Wiring (AWG)	Required Overcurrent Protection (A)	Supply Wiring (AWG)	Required Overcurrent Protection (A)
20	5.0	26	1.0
22	3.0	28	0.8
24	1.0	30	0.5

Certifications



Banner Engineering BV
 Park Lane, Culliganlaan 2F bus 3
 1831 Diegem, BELGIUM



Turck Banner LTD Blenheim House
 Blenheim Court
 Wickford, Essex SS11 8YT
 GREAT BRITAIN



Dimensions

All measurements are listed in millimeters [inches], unless noted otherwise.

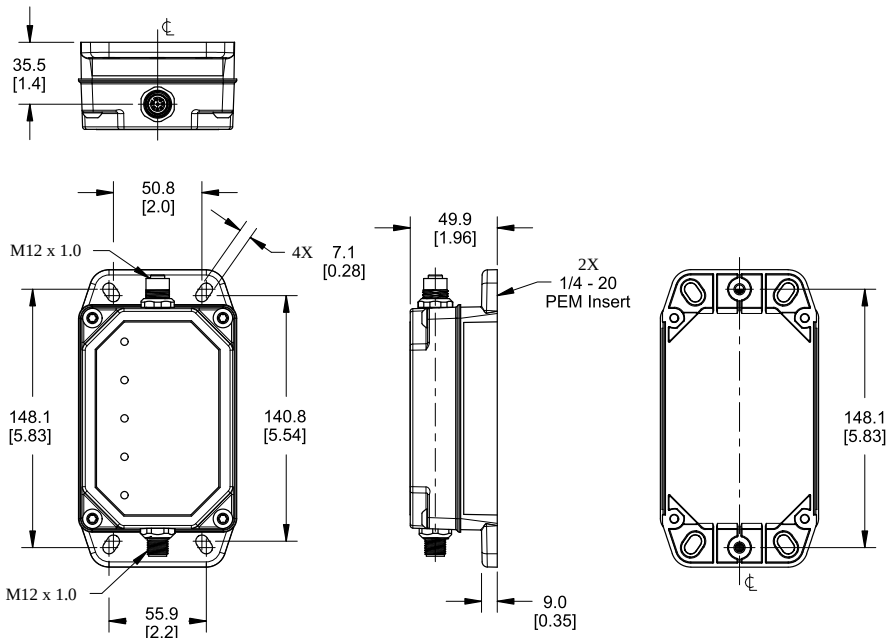

Accessories

Cordsets





5-Pin Threaded M12 Cordsets—Single Ended				
Model	Length	Style	Dimensions	Pinout (Female)
MQDC1-501.5	0.5 m (1.5 ft)	Straight		<p>1 = Brown 2 = White 3 = Blue 4 = Black 5 = Gray</p>
MQDC1-503	0.9 m (2.9 ft)			
MQDC1-506	2 m (6.5 ft)			
MQDC1-515	5 m (16.4 ft)			
MQDC1-530	9 m (29.5 ft)			
MQDC1-560	18 m (59 ft)			
MQDC1-5100	31 m (101.7 ft)			

5-Pin Threaded M12 Cordsets—Double Ended					
Model	Length	Style	Dimensions	Pinout (Male)	Pinout (Female)
MQDEC-501SS	0.31 m (1.02 ft)	Male Straight/ Female Straight		<p>1 = Brown 2 = White 3 = Blue</p>	<p>4 = Black 5 = Gray</p>
MQDEC-503SS	0.91 m (2.99 ft)				
MQDEC-506SS	1.83 m (6 ft)				
MQDEC-512SS	3.66 m (12 ft)				
MQDEC-515SS	5 m (16.4 ft)				
MQDEC-530SS	9 m (29.5 ft)				
MQDEC-550SS	15 m (49.2 ft)				

8-Pin Threaded M12 Cordsets—Double Ended				
Model	Length	Style	Dimensions	Pinout
MQDEC1-803SS	1 m (3.28 ft)	Male Straight / Female Straight		<p>1 = White 2 = Brown 3 = Green 4 = Yellow 5 = Gray 6 = Pink 7 = Blue 8 = Red</p>
MQDEC1-806SS	2 m (6.56 ft)			
MQDEC1-810SS	3 m (9.84 ft)			
MQDEC1-815SS	5 m (16.4 ft)			
MQDEC1-830SS	9 m (29.5 ft)			
MQDEC1-850SS	15 m (49.2 ft)			
MQDEC1-8100SS	30.5 m (100 ft)			
MQDEC1-8200SS	61 m (200 ft)			

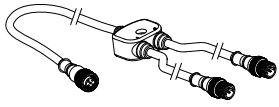
Pro Editor Hardware

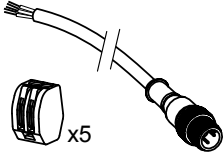
<p>MQDC-506-USB</p> <ul style="list-style-type: none"> • Pro Converter Cable • 1.83 m (6 ft) length 5-pin M12 quick disconnect to Device and USB to PC • Required for connection to Pro Editor 	
--	--

<p>CSB-M1251FM1251M</p> <ul style="list-style-type: none"> • 5-pin parallel Y splitter (Male-Male-Female) • For full Pro Editor preview capability • Requires external power supply, sold separately 	
<p>PSW-24-1</p> <ul style="list-style-type: none"> • 24 V DC, 1 A power supply • 2 m (6.5 ft) PVC cable with M12 quick disconnect • Provides external power with splitter cable, sold separately 	
<p>ACC-PRO-CABLE5</p> <ul style="list-style-type: none"> • Mating accessory for cabled and terminal models • 150 mm (6 inch) PVC cable with M12 quick disconnect • Lever wire nuts included (qty 5) • Required to connect cabled models and screw terminal models to Pro Converter Cable, sold separately 	
<p>MQDC-801-5M-PRO</p> <ul style="list-style-type: none"> • 8-pin to 5-pin double-ended cordset • 0.31 m (1 ft) PVC cable with M12 quick disconnects • Required to connect 8-pin Pro Series-enabled devices to Pro Converter Cable (MQDC-506-USB), sold separately 	

Banner Engineering Corp Limited Warranty

Banner Engineering Corp. warrants its products to be free from defects in material and workmanship for one year following the date of shipment. Banner Engineering Corp. will repair or replace, free of charge, any product of its manufacture which, at the time it is returned to the factory, is found to have been defective during the warranty period. This warranty does not cover damage or liability for misuse, abuse, or the improper application or installation of the Banner product.

THIS LIMITED WARRANTY IS EXCLUSIVE AND IN LIEU OF ALL OTHER WARRANTIES WHETHER EXPRESS OR IMPLIED (INCLUDING, WITHOUT LIMITATION, ANY WARRANTY OF MERCHANTABILITY OR FITNESS FOR A PARTICULAR PURPOSE), AND WHETHER ARISING UNDER COURSE OF PERFORMANCE, COURSE OF DEALING OR TRADE USAGE.

This Warranty is exclusive and limited to repair or, at the discretion of Banner Engineering Corp., replacement. **IN NO EVENT SHALL BANNER ENGINEERING CORP. BE LIABLE TO BUYER OR ANY OTHER PERSON OR ENTITY FOR ANY EXTRA COSTS, EXPENSES, LOSSES, LOSS OF PROFITS, OR ANY INCIDENTAL, CONSEQUENTIAL OR SPECIAL DAMAGES RESULTING FROM ANY PRODUCT DEFECT OR FROM THE USE OR INABILITY TO USE THE PRODUCT, WHETHER ARISING IN CONTRACT OR WARRANTY, STATUTE, TORT, STRICT LIABILITY, NEGLIGENCE, OR OTHERWISE.**

Banner Engineering Corp. reserves the right to change, modify or improve the design of the product without assuming any obligations or liabilities relating to any product previously manufactured by Banner Engineering Corp. Any misuse, abuse, or improper application or installation of this product or use of the product for personal protection applications when the product is identified as not intended for such purposes will void the product warranty. Any modifications to this product without prior express approval by Banner Engineering Corp will void the product warranties. All specifications published in this document are subject to change; Banner reserves the right to modify product specifications or update documentation at any time. Specifications and product information in English supersedes that which is provided in any other language. For the most recent version of any documentation, refer to: www.bannerengineering.com.

For patent information, see www.bannerengineering.com/patents.