

## Datasheet

The DXMR90-X1 Series Controller is an industrial controller within the Banner DXM family of controllers that consolidates, processes, and distributes data using industrial or web services protocols.



- Configurable controller works with a wide range of Modbus devices; quickly deploy Modbus slave device data to EtherNet/IP™, Modbus® TCP, or PROFINET® Networks<sup>(1)</sup>
  - Four independent Modbus master ports per converter increase simplicity and decrease deployment time for co-located assets
  - Connect up to four Modbus slave devices without manually assigning a slave address to connected devices
- Local control or connectivity with:
  - Automation protocols including EtherNet/IP, PROFINET, Modbus TCP, and Modbus RTU
  - Internet protocols including RESTful API and MQTT with web services from AWS

- Logic processing and problem solving capable of deploying solutions to process and control data from multiple devices
- Compact housing saves space and weight compared to traditional "block" style form factors
- IP67 housing simplifies installation in any location by eliminating the need for a control cabinet
- Consolidate cable runs to minimize cabling and associated weight, especially in weight critical applications such as robotics
- Flexible and Customizable—Expanded internal logic controller with action rules, MicroPython, and ScriptBasic programming

## DXMR90-X1 Models

Model	Ethernet Connection	Modbus Master Connections	Other Connections
DXMR90-X1	One female M12 D-Code Ethernet Connector	Four female M12 connections for Modbus master connections	One male M12 (Port 0) for incoming power and Modbus RS-485, one female M12 for daisy chaining Port 0 signals.

## Overview of the DXMR90-X1

Banner's DXMR90-X1 Series Controller consolidates data from multiple sources to provide local data processing as well as accessibility for host systems as a platform for the Industrial Internet of Things (IIoT).

The DXMR90-X1 contains four individual Modbus masters allowing for concurrent communication to up to four independent networks. Data is collected into the internal logic controller to facilitate edge processing, protocol conversion to Industrial Ethernet, and pushing information to web servers.

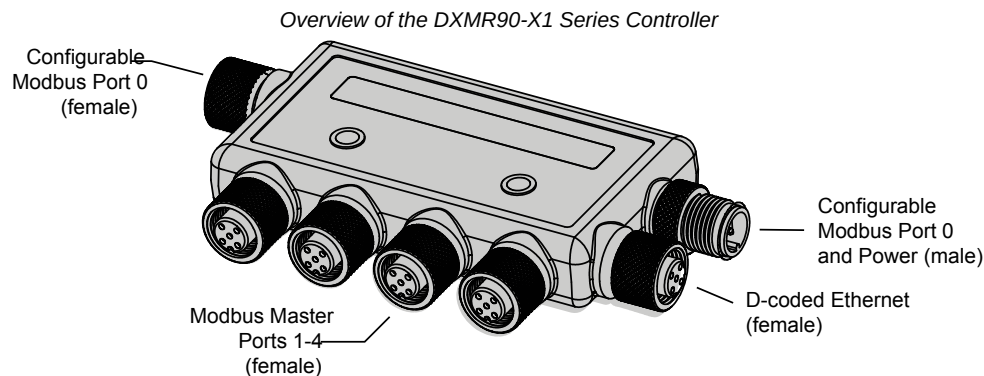

One male M12 connection provides common power and ground to all M12 Modbus ports. The two-port 0 Modbus connections can be configured as pass-through wiring to connect to a Modbus trunk. One 100 Mbps Ethernet port (female) using an M12 D-coded Ethernet connection.

- Modbus TCP
- EtherNet/IP
- Profinet
- Configuration/discovery port

Four Modbus master connections using female M12 connectors.

- 2-wire RS-485 physical transceiver with power/ground at each connector

<sup>(1)</sup> EtherNet/IP™ is a trademark of ODVA, Inc. Modbus® is a registered trademark of Schneider Electric USA, Inc. PROFINET® is a registered trademark of PROFIBUS Nutzerorganisation e.V. By default, the DXMR90-X1 Series Controller is set to a static IP address of 192.168.0.1.



- Separate Modbus master control and programmability for each connection point
- Independent and selectable baud rate and parity settings
- Individual timing and packet timing for each Modbus connection

## Installation Instructions

### Mechanical Installation

Install the DXMR90-X1 to allow access for functional checks, maintenance, and service or replacement. Do not install the DXMR90-X1 in such a way to allow for intentional defeat.

Fasteners must be of sufficient strength to guard against breakage. The use of permanent fasteners or locking hardware is recommended to prevent the loosening or displacement of the device. The mounting hole (4.5 mm) in the DXMR90-X1 accepts M4 (#8) hardware. See the figure below to help in determining the minimum screw length.

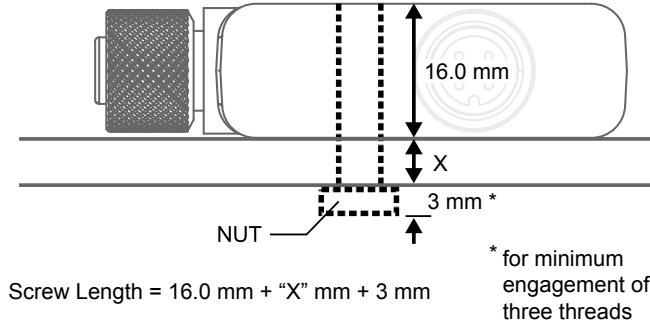

**CAUTION:** Do not overtighten the DXMR90-X1's mounting screw during installation. Overtightening can affect the performance of the DXMR90-X1.

### Wiring

#### Ports 0-4 female connector

Port 0-4 5-pin M12 Connector (female)	Pin	Wire Color	Description
	1	Brown (bn)	12 V DC to 30 V DC
	2	White (wh)	RS485 / D1 / B / +
	3	Blue (bu)	DC common (GND)
	4	Black (bk)	RS485 / D0 / A / -
	5	Gray (gy)	Not used/reserved



**CAUTION:**

- Wiring devices incorrectly will cause electrical damage.
- Do not apply more than 12 volts on pins 2 or 4 for ports 1 through 4.

#### Port 0 male connector

Port 0 4-pin M12 Connector (male)	Pin	Wire Color	Description
	1	Brown (bn)	12 V DC to 30 V DC
	2	White (wh)	RS485 / D1 / B / +
	3	Blue (bu)	DC common (GND)
	4	Black (bk)	RS485 / D0 / A / -

*D-coded industrial Ethernet connector*

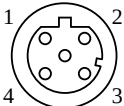
4-pin Industrial Ethernet Connector (female)	Pin	Wire Color	Description
	1	Black (bk)	+Tx
	2	Red (rd)	+Rx
	3	Green (gn)	-Tx
	4	White (wh)	-Rx

## Specifications for the DXMR90-X1

### Supply Voltage

12 V DC to 30 V DC

### Supply Protection Circuitry

Protected against reverse polarity and transient voltages

### Power Consumption

120 mA maximum at 12 V DC

### Construction

Connector Body: PVC translucent black

### Indicators

Amber: Power port 0

Amber: Modbus communications port 0-4

Green/amber: Ethernet communications

Red/amber/green: User-configurable LEDs

### Connections

Five integral 5-pin M12 female quick disconnect

One integral 4-pin M12 male quick disconnect

One integral 5-pin M12 female D-Code quick disconnect

### Application Note

When connecting external devices through the DXMR90-X1, it is important not to exceed maximum current limitations of 3.5 Amps

### Communication Hardware (RS-485)

Interface: 2-wire half-duplex RS-485

Baud rates: 1.2K, 2.4K, 9.6k, 19.2k (default), 38.4k, 57.6K, or 115.2K

Data format: 8 data bits, no parity, 1 stop bit

### Communication Protocols

Modbus® RTU, Modbus/TCP, EtherNet/IP™, and PROFINET®

EtherNet/IP™ is a trademark of ODVA, Inc. Modbus® is a registered trademark of Schneider Electric USA, Inc. PROFINET® is a registered trademark of PROFIBUS Nutzerorganisation e.V.

### Security Protocols

TLS, SSL, HTTPS

### Environmental Ratings

For Indoor Use Only

IP65, IP67, NEMA 1, UL Type 1

### Vibration and Mechanical Shock

Meets IEC 60068-2-6 requirements (Vibration: 10 Hz to 55 Hz, 1.0 mm amplitude, 5 minutes sweep, 30 minutes dwell)

Meets IEC 60068-2-27 requirements (Shock: 30G 11 ms duration, half sine wave)

### Operating Conditions

-40 °C to +70 °C (-40 °F to +158 °F)

90% at +70 °C maximum relative humidity (non-condensing)

### Storage Temperature

-40 °C to +80 °C (-40 °F to +176 °F)

### Certifications



Banner Engineering BV  
Park Lane, Culliganlaan 2F bus 3  
1831 Diegem, BELGIUM



Turck Banner LTD Blenheim House  
Blenheim Court  
Wickford, Essex SS11 8YT  
GREAT BRITAIN

(CE/UKCA approval only applies to 2.4 GHz models)

### Required Overcurrent Protection



**WARNING:** Electrical connections must be made by qualified personnel in accordance with local and national electrical codes and regulations.

Overcurrent protection is required to be provided by end product application per the supplied table.

Overcurrent protection may be provided with external fusing or via Current Limiting, Class 2 Power Supply.

Supply wiring leads < 24 AWG shall not be spliced.

For additional product support, go to [www.bannerengineering.com](http://www.bannerengineering.com).

Supply Wiring (AWG)	Required Overcurrent Protection (A)	Supply Wiring (AWG)	Required Overcurrent Protection (A)
20	5.0	26	1.0
22	3.0	28	0.8
24	1.0	30	0.5

## Dimensions

All measurements are listed in millimeters, unless noted otherwise.

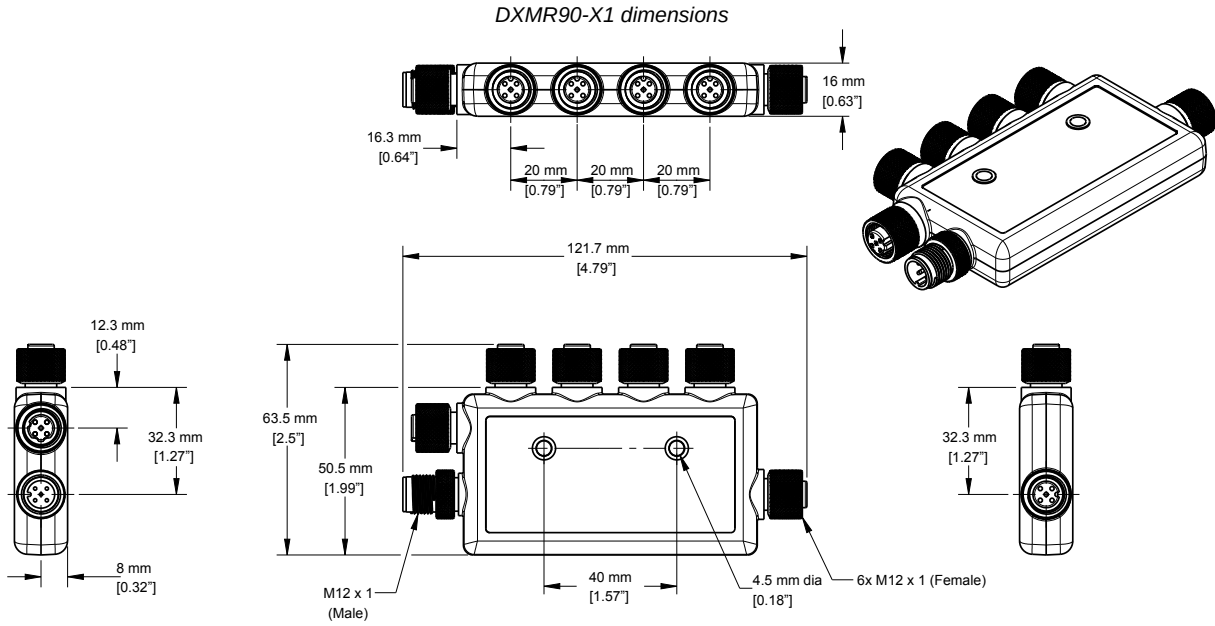

## Accessories for the DXMR90-X1

### Power Supplies

- [PSD-24-4](#)—DC Power Supply, Desktop style, 3.9 A, 24 V DC, Class 2, 4-pin M12/Euro-style quick disconnect (QD)
- [PSDINP-24-06](#)—DC power supply, 0.63 Amps, 24 V DC, with DIN Rail Mount, Class I Division 2 (Groups A, B, C, D) Rated
- [PSDINP-24-13](#)—DC power supply, 1.3 Amps, 24 V DC, with DIN Rail Mount, Class I Division 2 (Groups A, B, C, D) Rated
- [PSDINP-24-25](#)—DC power supply, 2.5 Amps, 24 V DC, with DIN Rail Mount, Class I Division 2 (Groups A, B, C, D) Rated
- [PSW-24-1](#)—DC power supply with multi-blade wall plug, 100–240 V AC 50/60 Hz input, 24 V DC 1 A output, UL Listed Class 2, 4-pin female M12 connector
- [PSWB-24-1](#)—DC power supply with multi-blade wall plug, 100–240 V AC 50/60 Hz input, 24 V DC 1 A output, UL Listed Class 2, barrel jack connector

### SMBR90S

- Stainless steel bracket
- 4x M4-07 pemnuts (B)
- Includes 2x M4 stainless steel hex head screws and flat washers

**Hole center spacing:** A = 40, B = 20

**Hole size:** A =  $\varnothing$  5

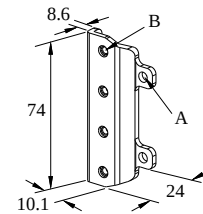

### 4-Pin Threaded M12 RS-485 to USB Adapter Cordset, with Wall Plug

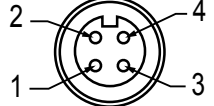
Model	Length	Style	Dimensions	Pinout (Female)
BWA-UCT-900	1 m (3.28 ft)	Straight		 <p>1 = Brown 2 = White 3 = Blue 4 = Black</p>

4-Pin Threaded M12 Cordsets—Double Ended				
Model	Length	Style	Dimensions	Pinout
MQDEC-401SS	0.31 m (1 ft)	Male Straight / Female Straight		<p>Female</p>
MQDEC-403SS	0.91 m (2.99 ft)			
MQDEC-406SS	1.83 m (6 ft)			
MQDEC-412SS	3.66 m (12 ft)			
MQDEC-420SS	6.10 m (20 ft)			
MQDEC-430SS	9.14 m (30.2 ft)			
MQDEC-450SS	15.2 m (49.9 ft)	Male Right-Angle / Female Straight		<p>Male</p> <p>1 = Brown 2 = White 3 = Blue 4 = Black</p>
MQDEC-403RS	0.91 m (2.99 ft)			
MQDEC-406RS	1.83 m (6 ft)			
MQDEC-412RS	3.66 m (12 ft)			
MQDEC-420RS	6.10 m (20 ft)			
MQDEC-430RS	9.14 m (30.2 ft)			
MQDEC-450RS	15.2 m (49.9 ft)	Male Right-Angle / Female Right-Angle		
MQDEC-403RR	0.9 m (2.9 ft)			
MQDEC-406RR	1.8 m (5.9 ft)			
MQDEC-412RR	3.6 m (11.8 ft)			
MQDEC-420RR	6.1 m (20 ft)			

5-Pin Threaded M12 Cordsets—Single Ended				
Model	Length	Style	Dimensions	Pinout (Female)
MQDC1-501.5	0.5 m (1.5 ft)	Straight		
MQDC1-503	0.9 m (2.9 ft)			
MQDC1-506	2 m (6.5 ft)			
MQDC1-515	5 m (16.4 ft)			
MQDC1-530	9 m (29.5 ft)			
MQDC1-560	18 m (59 ft)			
MQDC1-5100	31 m (101.7 ft)			
MQDC1-506RA	2 m (6.5 ft)	Right-Angle		<p>1 = Brown 2 = White 3 = Blue 4 = Black 5 = Gray</p>
MQDC1-515RA	5 m (16.4 ft)			
MQDC1-530RA	9 m (29.5 ft)			
MQDC1-560RA	19 m (62.3 ft)			

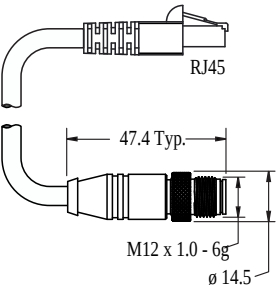
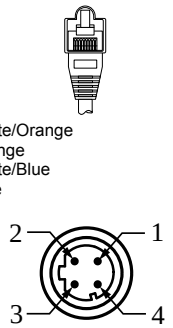
4-pin M12 D-code to RJ45 Shielded Ethernet				
Model	Length	Style	Dimensions	Pinout (Male)
STP-M12D-406	1.83 m (6 ft)	Straight		 <p>1 = White/Orange 2 = Orange 3 = White/Blue 6 = Blue</p> <p>1 = White/Orange 2 = White/Blue 3 = Orange 4 = Blue</p>
STP-M12D-415	4.57 m (15 ft)			
STP-M12D-430	9.14 m (30 ft)			

## Banner Engineering Corp Limited Warranty

Banner Engineering Corp. warrants its products to be free from defects in material and workmanship for one year following the date of shipment. Banner Engineering Corp. will repair or replace, free of charge, any product of its manufacture which, at the time it is returned to the factory, is found to have been defective during the warranty period. This warranty does not cover damage or liability for misuse, abuse, or the improper application or installation of the Banner product.

**THIS LIMITED WARRANTY IS EXCLUSIVE AND IN LIEU OF ALL OTHER WARRANTIES WHETHER EXPRESS OR IMPLIED (INCLUDING, WITHOUT LIMITATION, ANY WARRANTY OF MERCHANTABILITY OR FITNESS FOR A PARTICULAR PURPOSE), AND WHETHER ARISING UNDER COURSE OF PERFORMANCE, COURSE OF DEALING OR TRADE USAGE.**

This Warranty is exclusive and limited to repair or, at the discretion of Banner Engineering Corp., replacement. **IN NO EVENT SHALL BANNER ENGINEERING CORP. BE LIABLE TO BUYER OR ANY OTHER PERSON OR ENTITY FOR ANY EXTRA COSTS, EXPENSES, LOSSES, LOSS OF PROFITS, OR ANY INCIDENTAL, CONSEQUENTIAL OR SPECIAL DAMAGES RESULTING FROM ANY PRODUCT DEFECT OR FROM THE USE OR INABILITY TO USE THE PRODUCT, WHETHER ARISING IN CONTRACT OR WARRANTY, STATUTE, TORT, STRICT LIABILITY, NEGLIGENCE, OR OTHERWISE.**

Banner Engineering Corp. reserves the right to change, modify or improve the design of the product without assuming any obligations or liabilities relating to any product previously manufactured by Banner Engineering Corp. Any misuse, abuse, or improper application or installation of this product or use of the product for personal protection applications when the product is identified as not intended for such purposes will void the product warranty. Any modifications to this product without prior express approval by Banner Engineering Corp will void the product warranties. All specifications published in this document are subject to change; Banner reserves the right to modify product specifications or update documentation at any time. Specifications and product information in English supersede that which is provided in any other language. For the most recent version of any documentation, refer to: [www.bannerengineering.com](http://www.bannerengineering.com).

For patent information, see [www.bannerengineering.com/patents](http://www.bannerengineering.com/patents).

Document title: Sure Cross® DXMR90-X1 Series Controller

Part number: 223673

Revision: B

© Banner Engineering Corp. All rights reserved.