

DXMR90-4K IO-Link Master Instruction Manual



Contents

Chapter 1 IO-Link Overview

IO-Link Systems	5
IO-Link Port/Operating Modes.....	6
Combining IO-Link Devices with Different Specifications	6

Chapter 2 DXMR90-4K Overview

DXMR90-4K Models.....	8
Automation Procotols	8
Dimensions	8

Chapter 3 Quick Start Guide

Apply Power to the Controller.....	11
Wiring for the DXMR90-4K	11
Configuration Instructions.....	12
DXM Configuration Software	12
Configuring the DXMR90-4K Controller.....	13
Installing the DXMR90-4K	16

Chapter 4 Controller Connections

Status Indicators for the DXMR90-4K	18
Ethernet	18
Internal Local Registers (Modbus ID 199).....	18
Connecting to Remote IO-Link Devices	21
Replacing an IO-Link Device During Operation (Backup/Restore Mode).....	22
Configuring Connected Banner IO-Link Devices.....	23
Connecting to Remote Modbus Devices	24
Define an RTU Read Rule	24
Example Read Rules Configuration.....	25

Chapter 5 Configuration Instructions

Set the Controller to use Authentication	27
Set the Web Services to Use Authentication	27
Controller Configuration Authentication	28
Register Flow and Configuration	28
Basic Approach to Configuration	29
Troubleshooting a Configuration	29
Saving and Loading Configuration Files	29
Uploading or Downloading Configuration Files	29
EtherNet/IP™ Configuration	29
Configuring the Host PLC	29
Configuring the Controller	30
Commissioning and Connecting IO-Link Devices to a Rockwell PLC with Add-On Instructions.....	30
Push Retries	31

Chapter 6 PROFINET®

General Station Description Markup Language File	33
DXM PROFINET IO Data Model	33
Configure the DXM Controller for a PROFINET IO Connection	33
Save and Upload the Configuration File	15
Slots and Modules for DXM PROFINET.....	34
Configuration Instructions	12
Install the GSD File	36
Change the Device IP Address	38
Change the Device Name	39

Chapter 7 Accessories for the DXMR90-4K 41

Chapter 8 Product Support and Maintenance

Specifications for the DXMR90-4K	43
File System and Archive Process	44
Update Your DXM Processor Firmware Using the Configuration Software	44
DXM Support Policy	44
Firmware Updates	45
Website Information	45
Feature Requests	45
Potential DXM Issues	45
DXM Security	45
Contact Us	45
Warnings	45
Banner Engineering Corp Limited Warranty	46
.....	47

Blank page

Chapter Contents

IO-Link Systems 5
IO-Link Port/Operating Modes..... 6
Combining IO-Link Devices with Different Specifications 6

Chapter 1 IO-Link Overview

IO-Link is an open standard serial communication protocol that allows for the bi-directional exchange of data from IO-Link-supported devices, such as sensors, that are connected through IO-Link.

Advantages to an IO-Link system include standardized wiring, remote configuration, simple device replacement, advanced diagnostics, and increased data availability. Because IO-Link is an open standard, the devices can be integrated in almost any fieldbus or automation system.

An IO-Link system consists of an IO-Link master and an IO-Link device such as a sensor, lighting product, IO-Link hub, or actuator.

The functions and parameters of the IO-Link devices are represented in a device description file (IODD). IODD files contain information about identification, device parameters, process and diagnostic data, communication properties, and other details. The IODD files for Banner IO-link devices can be downloaded for free on www.bannerengineering.com.

IO-Link Systems

At least one IO-Link master and one IO-Link device are required for IO-Link communication.

The IO-Link master and IO-Link device are connected using a 3-wire standard unshielded cable. The IO-Link master establishes the connection between IO-Link device and the higher-level control system. An IO-Link master can have several IO-Link ports, and only one IO-Link device can be connected to each port.

IO-Link hubs such as Banner's **R90C-4B21-KQ** or IO-link converters make it possible to integrate devices without an IO-Link output in automation systems via IO-Link.

IO-Link map

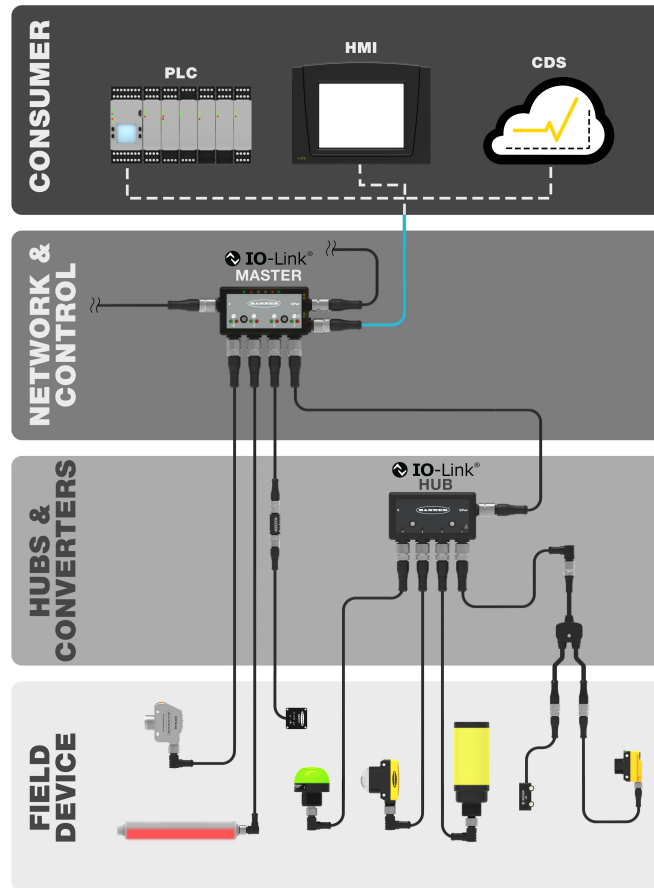

IO-Link Port/Operating Modes

The operating mode can be configured for any port on the IO-Link master. The following modes can be used:

Deactivated

Use deactivated mode for any unused IO-link master ports if a device is not connected.

IO-Link Manual

The IO-Link master only connects IO-Link devices that have a certain vendor ID and device ID (1: IOL_MANUAL).

This mode is also required to for the Backup and Restore or Restore function.

IO-Link Autostart

The IO-Link master connects to every connected IO-Link device (2: IOL_AUTOSTART).

Digital Input

The IO-Link port functions as a standard digital input (3: DI_C/Q).

Digital Output

The IO-Link port functions as a standard digital output (4: DO_C/Q).

Combining IO-Link Devices with Different Specifications

Any combination of masters and devices is possible. However, if IO-Link devices of a different IO-Link specification are combined, note that:

- Only IO-Link v1.0 devices can be operated on the IO-Link v1.0 masters
- IO-Link v1.0 and v1.1 devices can be operated on the IO-Link v1.1 masters

IO-Link devices with IO-Link specification V1.0 do not support backup and restore features (data storage).

Chapter Contents

DXMR90-4K Models 8
 Automation Protocols 8
 Dimensions 8

Chapter 2 DXMR90-4K Overview

Banner's DXMR90-4K IO-Link Master consolidates data from multiple sources to provide local data processing as well as accessibility for host systems as a platform for the Industrial Internet of Things (IIoT).

The DXMR90-4K IO-Link Master 4-port IO-link device serves as the gateway for the connection of up to 4 IO-link devices including sensors, lighting products, IO-link hubs, and more. The DXMR90-4K IO-Link Master can have multiple configurations and includes a model number label on the housing. Use this model number to identify which boards are included in your controller.



The DXMR90-4K contains four IO-link ports, allowing for concurrent communication to up to four IO-Link devices. Data is collected into the internal logic controller to facilitate edge processing, protocol conversion to Industrial Ethernet, Modbus/TCP, and pushing information to web servers. In addition to IO-Link devices, the IO-Link master can be used to transmit up to eight discrete signals using pin 2 or pin 4 of the IO-link master ports.

The configurable IO-link master device works with IO-link devices and allows for quick deployment of IO-link data to Ethernet, PROFINET, Modbus TCP, and Modbus RTU networks.

- Local control or connectivity with automation protocols, including EtherNet/IP, PROFINET, Modbus/TCP, and Modbus RTU⁽¹⁾
- Logic processing and problem-solving capable of deploying solutions to process and control data from multiple devices
- Compact housing saves space and weight compared to traditional "block" style form factors
- IP67 housing simplifies installation in any location by eliminating the need for a control cabinet
- Consolidate cable runs to minimize cabling and associated weight, especially in weight-critical applications such as robotics
- Flexible and Customizable—Expanded internal logic controller with action rules and ScriptBasic programming

Logic Controller

Program the DXMR90-4K's logic controller using action rules and/or ScriptBasic programming languages, which can execute concurrently. The control functions allow freedom when creating custom sensing and control sequences. The logic controller supports the Modbus protocol standards for data management, ensuring seamless integration with existing automation systems. File password protection is an option.

⁽¹⁾ EtherNet/IP™ is a trademark of ODVA, Inc. Modbus® is a registered trademark of Schneider Electric USA, Inc. PROFINET® is a registered trademark of PROFIBUS Nutzerorganisation e.V. By default, the DXMR90-4K IO-Link Master is set to a static IP address of 192.168.0.1.

Action Rules

- Thresholds (IF/THEN/ELSE) with timers, minimum on/off time
- Math/Logic Rules (arithmetic and bitwise operators)
- Control Logic (logical operators and SR/T/D/JK flip flops)
- Trending (multiple averaging filters)
- Tracking (counts, on/off times)
- Push data on conditions

Programming Language—ScriptBasic to create variables, arrays, functions, loops, IF/THEN/ELSE, logical and arithmetic operators, API commands, register access, string functions and operators, time commands

Scheduler

- Time/calendar-based events
- Holiday skips
- One-time events
- Dynamic scheduler updating

- Astronomical clock

Push to the Cloud

Register Mapping

- Cyclical Read rules from wireless devices or local wired Modbus devices that include optional scaling, error conditions, and the ability to activate a read rule
- Cyclical or Change of State Write rules to local wired Modbus devices with scaling
- Modbus/TCP Controller/Primary Read or Write rules for external devices on the network

Wired Connectivity

Ethernet: Modbus/TCP (client/server), Ethernet/IP, or PROFINET

User Interface

API Interface—Host Initiated control and Web service integration

DXMR90-4K Models

Model	Ethernet Connection	IO-Link Master Connections	Other Connections
DXMR90-4K	One female M12 D-Code Ethernet Connector	Four female M12 connections for IO-Link master connections	One male M12 (Port 0) for incoming power and Modbus RS-485, one female M12 for daisy chaining Port 0 signals.

Automation Protocols

The DXMR90-4K IO-Link Master supports the following automation protocols.

EtherNet/IP™

By default, EtherNet/IP is enabled. Configure the DXMR90-4K Local Registers as EtherNet/IP input or output registers using the DXM Configuration Software. A single register can only be set as either an EtherNet/IP input or output register.

EtherNet/IP registers are limited to 228 read registers set as **E/IP Originator to DXM** and 228 write registers set as **DXM to Originator**

Modbus® RTU

Modbus RTU port (port 0) is used by a host system to access the DXMR90-4K as a slave device. The slave Modbus RTU port allows access to all the internal local registers concurrently with the master RTU port. Port 0 can be configured as a Modbus Master Port using the DXM Configuration Software but is defined as a slave port by default.

Configure to a Master port using the DXM Configuration Software to allow for data access to other Modbus devices like the 4-Port IO-Link to Modbus Master R90C-4K-MQ or other Modbus accessible slave devices.

Modbus® TCP/IP

A host system acting as a Modbus master (Client) can access the DXMR90-4K using the Modbus TCP/IP protocol over Ethernet. Standard Modbus TCP port 502 is used by the DXMR90-4K for all Modbus TCP/IP requests.

All internal local registers are available to the host system concurrently with Modbus TCP.

By default, the DXMR90-4K is configured as a Modbus TCP/IP Server.

PROFINET®

By default, PROFINET is disabled on the DXMR90-4K. To enable and configure the DXMR90-4K for PROFINET communications, use the DXM Configuration Software.

The DXMR90-4K uses fixed slot sizes and locations in the Local Registers for the input and output values. Supported module sizes are 64, 128, 256, and 512 bytes, which range from 32 to 256 in the DXM's Local Registers.

Modbus® is a registered trademark of Schneider Electric USA, Inc. IO-Link® is a registered trademark of PROFIBUS Nutzerorganisation e.V. PROFINET® is a registered trademark of PROFIBUS Nutzerorganisation e.V. EtherNet/IP™ is a trademark of ODVA, Inc. All other trademarks and registered trademarks cited are the property of their respective owners.

Dimensions

All measurements are listed in millimeters, unless noted otherwise.

DXMR90-4K dimensions

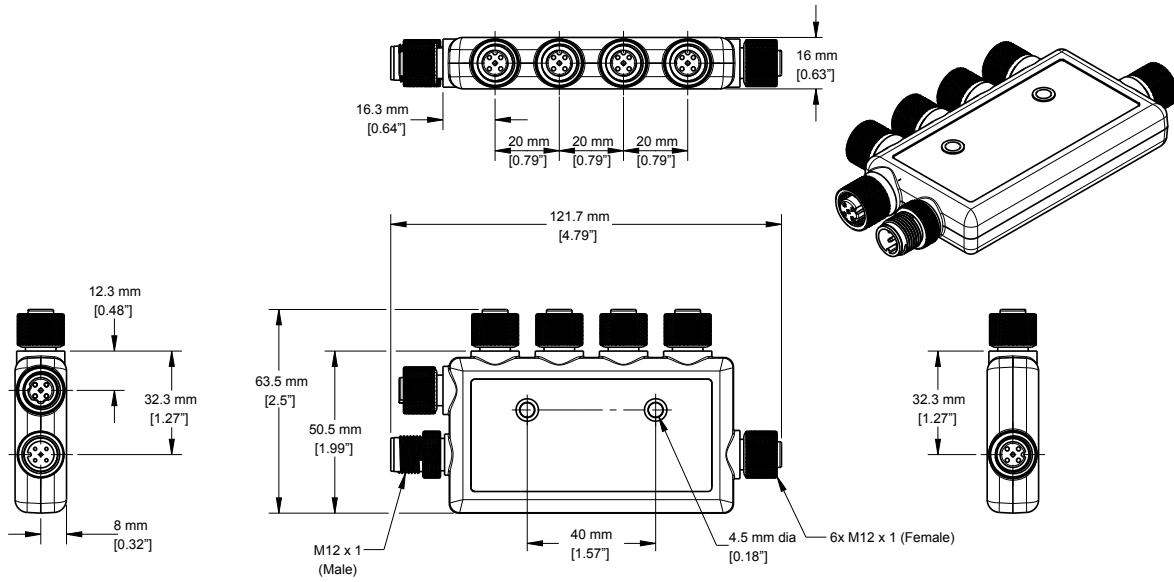

Blank page

Chapter Contents

Apply Power to the Controller..... 11
 Configuration Instructions..... 12
 Installing the DXMR90-4K..... 16

Chapter 3 Quick Start Guide

Apply Power to the Controller

Follow these instructions to apply 12–30 V DC power to the DXMR90-4K using a wall plug.

Required equipment:

- DXMR90-4K IO-Link Master
 - **PSW-24-1** Wall plug power supply; 24 V DC, 1 A (or equivalent 24 V DC M12 power supply)
1. Connect the **PSW-24-1** power supply to the male M12 connector on the DXMR90-4K, Port 0.
 2. Plug in the **PSW-24-1** wall plug power supply.

Wiring for the DXMR90-4K

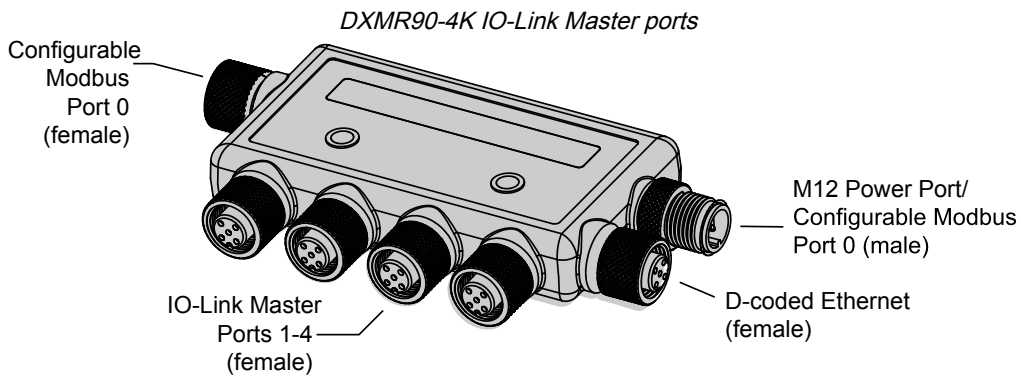

Ports 1-4 female connector

Port 1-4 5-pin M12 Connector (female)	Pin	Wire Color	Description
	1	Brown (bn)	18 V DC to 30 V DC
	2	White (wh)	I/Q (digital in-out)
	3	Blue (bu)	DC common (GND)
	4	Black (bk)	C/Q (communications/digital in-out)
	5	Gray (gy)	Not used/reserved

Port 0 male connector

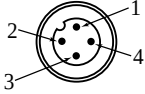
Port 0 4-pin M12 Connector (male)	Pin	Wire Color	Description
	1	Brown (bn)	18 V DC to 30 V DC
	2	White (wh)	RS485 / D1 / B / +
	3	Blue (bu)	DC common (GND)
	4	Black (bk)	RS485 / D0 / A / -

Port 0 female connector

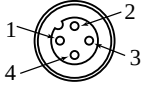
Port 0 4-pin M12 Connector (female)	Pin	Wire Color	Description
	1	Brown (bn)	18 V DC to 30 V DC
	2	White (wh)	RS485 / D1 / B / +
	3	Blue (bu)	DC common (GND)
	4	Black (bk)	RS485 / D0 / A / -

D-coded industrial Ethernet connector

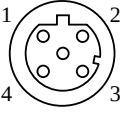
4-pin Industrial Ethernet Connector (female)	Pin	Wire Color	Description
	1	Black (bk)	+Tx
	2	Red (rd)	+Rx
	3	Green (gn)	-Tx
	4	White (wh)	-Rx

Configuration Instructions

DXM Configuration Software

Configure the DXMR90-4K using the configuration [software](#). Use this software to customize your configuration and to process data from the Controller.

Download the latest version of all configuration software from <http://www.bannerengineering.com>. For more information on using the DXM Configuration Software, refer to the instruction manual (p/n 209933).

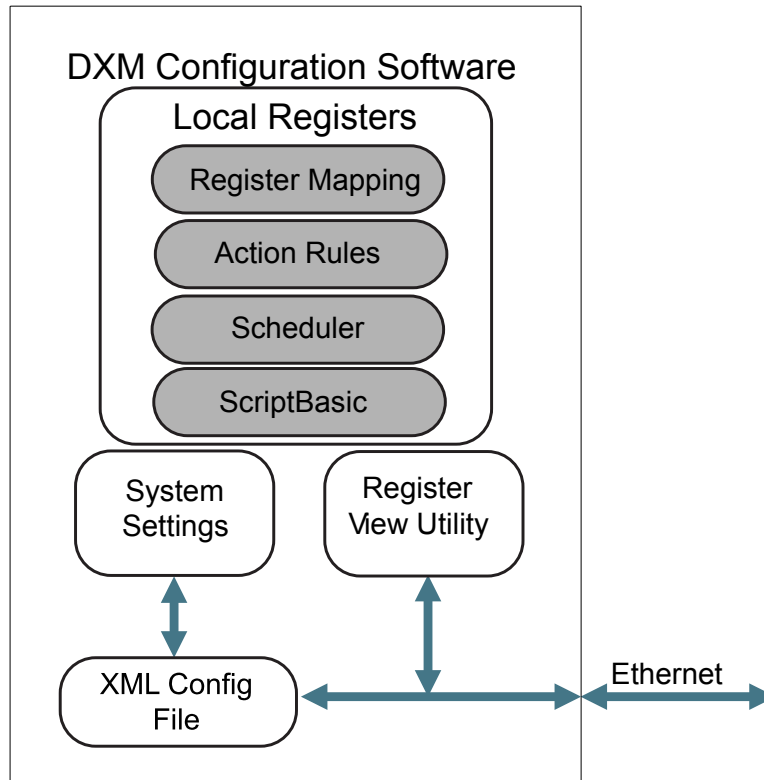
Overview of the configuration software features

The configuration software creates an XML file that is transferred to the DXM using an Ethernet connection. The DXM can also receive the XML configuration file from a Web server using an Ethernet connection. This configuration file governs all aspects of the DXM operation. The DXM Configuration Software allows the user to define parameters for the DXMR90-4K, then saves the configuration in an XML file on the PC.

After the configuration file is saved, upload the XML configuration file to the DXMR90-4K for operation.

IMPORTANT: The DXMR90-4K IO-Link Master comes preloaded with a default configuration XML file. You can download the default XML on the product page for the DXMR90-4K.

This quick start guide outlines the basic operations to set up a DXMR90-4K using the configuration software. For a more comprehensive explanation of features, refer to the DXM Configuration Software Instruction Manual (p/n [209933](#)).

Configuring the DXMR90-4K Controller

This section will walk you through the method of setting up the DXM Configuration Software and communicating with a connected DXM device. Version 4 of the DXM Configuration Software supports multiple DXM device models, each of which incorporates different features.

As soon as a DXM model is connected to your computer, the software automatically detects the correct model and loads the appropriate screens. You may also manually select which model of DXM you are configuring if you intend to create a configuration file without connecting a device. This ensures that the interface and the configuration file use the correct features.

Not all screens are available for all models. To change to another model of DXM, go to the Select Mode screen and use the drop-down list to select another model. If the active configuration is incompatible with the selected model, you will be prompted to either proceed and wipe out the active configuration or cancel the model change and preserve the configuration.

Opening splash screen for Traditional Setup mode

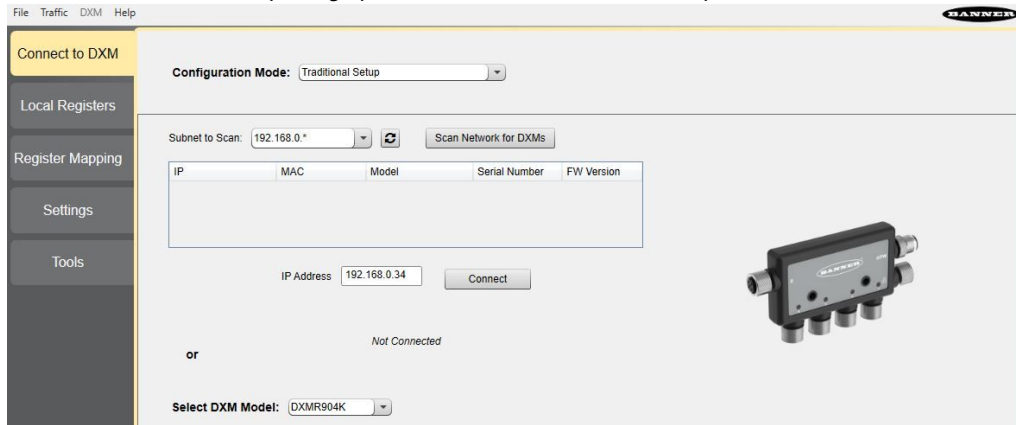

When the **Select DXM Model** drop-down is set to DXMR90-4K, a new network discovery table is displayed. Click **Scan Network for DXMs** to detect DXM devices on the host computer's network. Discovered DXMs are listed in the network discovery table. Double-click any row entry to connect to that DXM. If the DXM's IP address is already known, the standard TCP connection option is available below the network discovery table.

The default IP address of the DXMR90-4K is 192.168.0.1. To connect to the device, you need to be on the same subnet. You can do this by accessing the control panel on your PC and accessing your Network Connections properties. It is important to ensure that the adaptor you are connected to is within the 192.168.0.* subnet when you first connect to the DXMR90-4K IO-link master.

Windows Network Properties settings screen

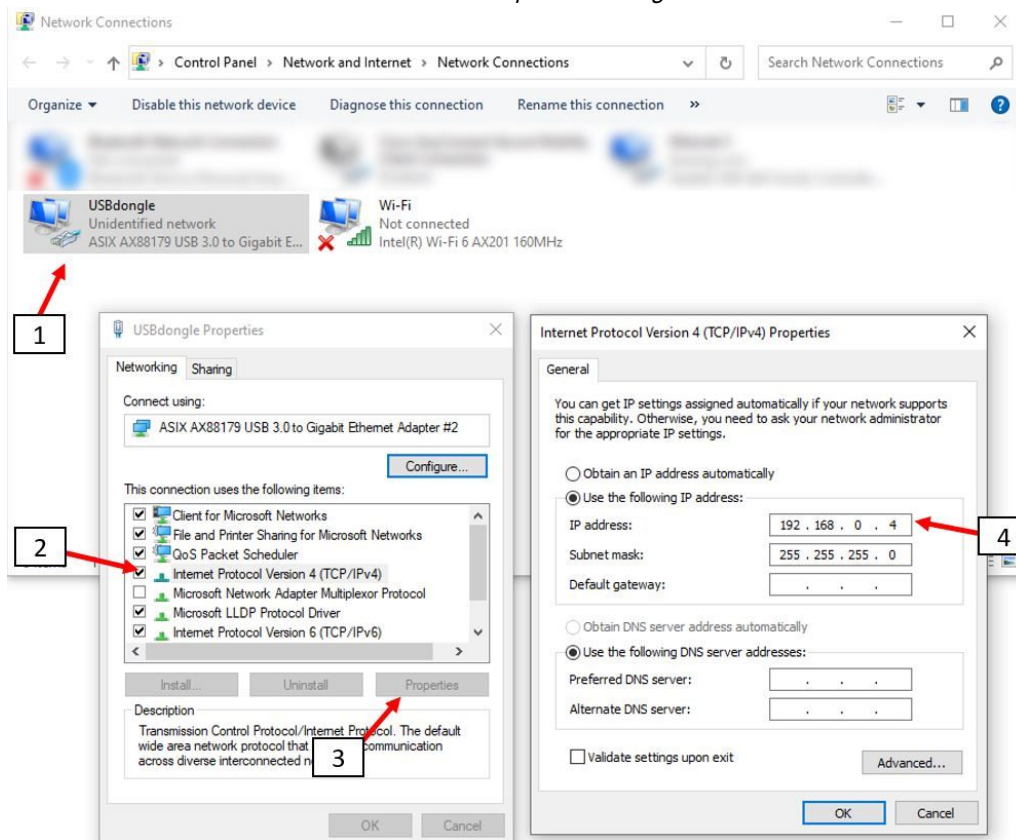

IMPORTANT: Any model of DXM may connect to the configuration software regardless of which device model is selected in the configuration software. Compatibility is checked before configuration files are uploaded to the device.

For more information on the device registers and port settings of the DXMR90-4K IO-Link Master, refer to the DXMR90-4K IO-Link Master IO-Link Master Device Register Map (p/n 229732).

Modify Multiple Registers

Modify a range of registers from the **Local Registers > Local Registers in Use > Modify Multiple Registers** screen.

Select which parameter fields to modify. Most parameters have three selections.

- Unchanged—no changes
- Default—change to default settings
- Set—modify the parameter. Other selections will appear based on the parameter.

Modify Multiple Registers screen

1. Enter the **Starting register** and **Ending register**.
2. Select the value to change using the drop-down list next to each value.
3. Enter the new value in the field provided.
4. To push register values to the web server, set **Cloud Permissions** to read.
If the **Cloud Permissions** are set to Read, the web server only views data from the device and cannot write data to the device. If the permissions are set to Write, the web server only writes to the device and cannot read the data. If the permissions are set to Read/Write, the web server can read the data from the device and write to the device from the web.
5. Click **Modify Registers** to save and apply the changes.

Set the IP Address

Follow these instructions to change the DXMR90-4K's IP address.

By default, the DXMR90-4K is set to a static IP address of 192.168.0.1. The IP address can be changed by using the DXM Configuration Software and updating the XML.

1. Launch the DXM Configuration Software.
2. Go to the **Settings > Ethernet** screen.
3. In the **IP Address** section, select **Static IP** or **DHCP** from the drop-down list.
 - If **Static IP** is selected, enter the **IP address**, **Subnet**, and **Gateway address** as desired.
 - If **DHCP** is selected, the **IP address**, **Subnet**, and **Gateway address** are grayed out and not configurable. Changing the IP Address to **DHCP** can make it so the DXM cannot be reached. Before changing this to **DHCP**, you **MUST** have a server that is going to assign an IP Address to the DXMR90-4K.
4. Save your changes to the configuration file (**File > Save**).
5. Upload the configuration file to your controller (**DXM > Send Configuration to DXM**).

Save and Upload the Configuration File

After making any changes to the configuration, you must save the configuration files to your computer, then upload it to the device.

Changes to the XML file are not automatically saved. Save your configuration file before exiting the tool and before sending the XML file to the device to avoid losing data. If you select **DXM > Send XML Configuration to DXM** before saving the configuration file, the software will prompt you to choose between saving the file or continuing without saving the file.

1. Save the XML configuration file to your hard drive by going to the **File > Save As** menu.
2. Go to the **DXM > Send XML Configuration to DXM** menu.

Status indicator bar

Connected 192.168.0.1	VibelQ_DXR90_V2.xml	Application Status	●
Connected 192.168.0.1	VibelQ_DXR90_V2.xml	Application Status	▬
Not Connected	VibelQ_DXR90_V2.xml	Application Status	●

- If the Application Status indicator is red, close and restart the DXM Configuration Tool, unplug and re-plug in the cable and reconnect the DXM to the software.
 - If the Application Status indicator is green, the file upload is complete.
 - If the Application Status indicator is gray and the green status bar is in motion, the file transfer is in progress.
- After the file transfer is complete, the device reboots and begins running the new configuration.

Installing the DXMR90-4K

Install the DXMR90-4K to allow access for functional checks, maintenance, and service or replacement.

Fasteners must be of sufficient strength to guard against breakage. The use of permanent fasteners or locking hardware is recommended to prevent the loosening or displacement of the device. The mounting hole (4.5 mm) in the DXMR90-4K accepts M4 (#8) hardware. See the figure below to help in determining the minimum screw length.

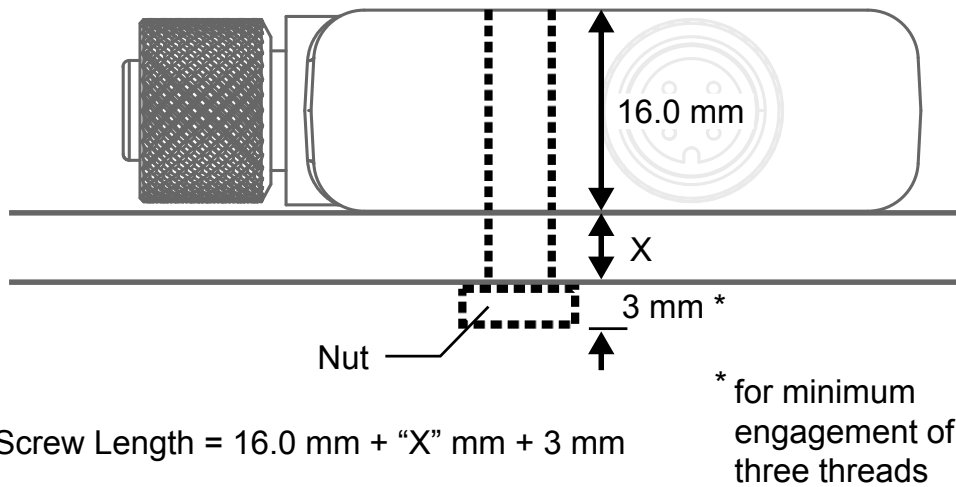

CAUTION: Do not overtighten the DXMR90-4K's mounting screw during installation. Overtightening can affect the performance of the DXMR90-4K.

Chapter Contents

Status Indicators for the DXMR90-4K	18
Ethernet	18
Internal Local Registers (Modbus ID 199).....	21
Connecting to Remote IO-Link Devices	23
Configuring Connected Banner IO-Link Devices	24
Connecting to Remote Modbus Devices.....	24

Chapter 4 Controller Connections

To connect IO-Link devices on machines in industrial environments, an M12 quick-disconnect connection is typically used. The pin assignment according to IEC 60974-5 is the following:

- Pin 1: 24 V DC
- Pin 2: Switching Digital I/O (PNP only)
- Pin 3: 0 V
- Pin 4: Switching Digital I/O (NPN, PNP, or Push-Pull) and IO-link Communication Line

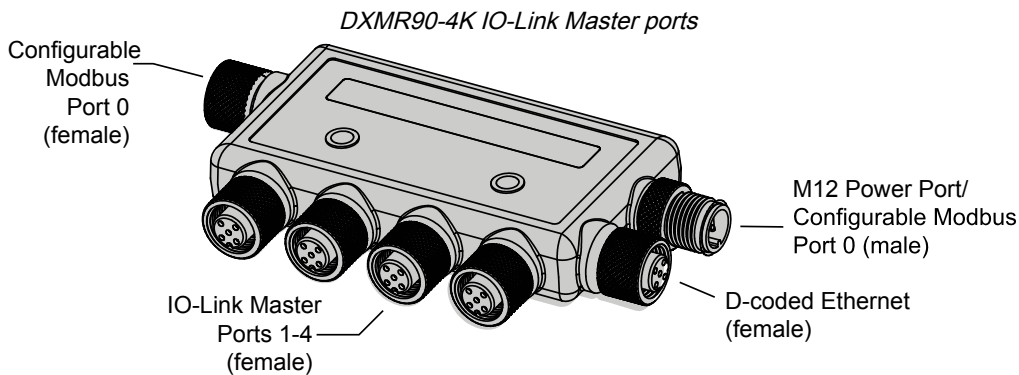
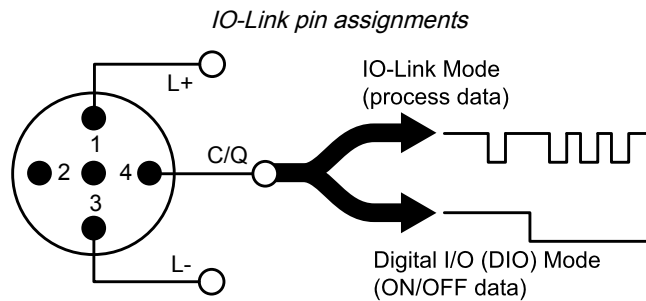

One male M12 connection provides common power and ground to all M12 IO-Link ports. One 100 Mbps Ethernet port (female) uses an M12 D-coded Ethernet connection.

- Modbus TCP
- EtherNet/IP
- PROFINET
- Configuration/discovery port

Four IO-Link controller connections using female M12 connectors.

- Separate IO-Link control and programmability for each connection point
- Configurable SIO mode on Input 1 and Input 2 of each IO-Link port

The DXMR90-4K IO-Link Master has 4 Class A ports. Pin 2 on these is an additional discrete IO channel. For specific pinout connections, see "Wiring for the DXMR90-4K" on page 11.

For more information on the device registers and port settings of the DXMR90-4K IO-Link Master, refer to the DXMR90-4K IO-Link Master IO-Link Master Device Register Map (p/n 229732).

Status Indicators for the DXMR90-4K

The DXMR90-4K IO-Link Master has two LED indicators for pin 2 and pin 4 for each IO-link port to provide indication visibility. There is also an additional amber LED indicator to indicate power to the IO-link master.

State	Pin 2	Pin 4
Off	SIO input mode and 0V in	Port is disabled
	SIO output mode and the output is turned off	SIO input mode and 0V in
	Pin 2 not configured	SIO output mode and the output is turned off
Solid green		An IO-Link device is connected
Flashing green		IO_Link autostart or manual mode, No device is connected
Solid amber	SIO input mode and 24 V in	SIO input mode and 24 V in
	SIO output mode and the output is turned on	SIO output mode and the output is turned on
Flashing amber		
Solid red	Electrical short	Electrical short
Flashing red		IO_Link manual, validation mode, and the wrong device is plugged in

Ethernet

Before applying power to the DXMR90-4K, verify the Ethernet cable is connected.

The Ethernet connection supports the DXM Configuration Software, Modbus/TCP, PROFINET, and EtherNet/IP. ScriptBasic also has access to Ethernet for custom programming. Use the software to configure the characteristics of the Ethernet connection, including the IP address. Any parameters not changeable from the menu system are configurable from the configuration software.

Internal Local Registers (Modbus ID 199)

The main storage elements for the DXMR90-4K are its Local Registers, which can store 4-byte values that result from register mapping, action rules or ScriptBasic commands.

For more information on the device registers and port settings of the DXMR90-4K IO-Link Master, refer to the DXMR90-4K IO-Link Master IO-Link Register Map document (p/n 229732).

Local Registers updated from Modbus and Ethernet/IP transactions are restricted to a 16-bit data value to follow the standard Modbus Holding Register definition.

The Local Registers defined in Action Rules must all be within the same register group. For example, an Action Rule cannot have inputs from an integer group with the result register defined as a floating point register. To move between integers and floats, use the Register Copy Rule.

Registers	Description
12001-12845, 17001-19000	32-bit unsigned integer-based registers

Continued on page 19

Continued from page 18

Registers	Description
12846-12850	Special function registers (can be reset registers)
12851-12900, 19001-20000	Non-volatile register with limited capability for permanent data storage
13001-17000	32-bit IEEE 754 floating point registers. Floating point values require two Local Registers to store a value. Floating point Local Registers are referenced on the odd-numbered register addresses: 13001, 13003, and 13005. When using Action Rules/Read Rules, always reference the odd-numbered register addresses.

Local Registers 12001–12845, and 17001–19000 (Internal Processor Memory, 32-bit, Unsigned)—The Local Registers are the main global pool of registers. Local Registers are used as basic storage registers and as the common data exchange mechanism. External Modbus device registers can be read into the Local Registers or written from the Local Registers. The DXMR90-4K, as a Modbus master device or a Modbus slave device, exchanges data using the Local Registers. Modbus over Ethernet (Modbus/TCP) uses the Local Registers as the accessible register data.

Local Registers 12846–12850 (Reset, Unsigned)—These Local registers are reserved for use as Reset registers. A time interval can be specified in the configuration software for the DXM to reset. If the data in the register does not change within the user-specified time interval, the DXM resets.

Local Registers 12851–12900 and 19001–20000 (Data Flash, Non-volatile, 32-bit, Unsigned)—The top 50 Local Registers are special non-volatile registers. The registers can store constants or calibration type data that must be maintained when power is turned off. This register data is stored in a data flash component that has a limited write capability of 100,000 cycles, so these registers should not be used as common memory registers that change frequently.

Local Registers 13001–17000—These Local Registers are paired together to store a 32-bit IEEE floating point format number in big endian format. Registers 12001 [31:16], 12002 [15:0] store the first floating point value; registers 12003, 12004 store the second floating point number. There are a total of 2000 floating point values; they are addressed as two 16-bit pieces to accommodate the Modbus protocol. Use these registers when reading/writing external devices that require Modbus registers in floating point format. Since Modbus transactions are 16-bits, the protocol requires two registers to form a 32-bit floating point number.

Virtual Registers—The DXMR90-4K has a small pool of virtual registers that show internal variables of the main processor. Some register values will be dependent upon the configuration settings of the DXMR90-4K. Do not use Read Rules to move Virtual Local Registers data into Local Registers. Use the Action Rule > Register Copy function to move Virtual Local Registers into Local Registers space (12001–12850).

Modbus registers for virtual registers

Registers	Definition	
22001	GPS latitude direction (N, S, E, W)	GPS Coordinate Data if the DXM is configured to read an external GPS unit.
22002	GPS latitude	
22003	GPS longitude direction (N, S, E, W)	
22004	GPS longitude	
22015–22016	Reboot cause (Restart Codes above)	Reboot Type
22017–22018	Watchdog reset count	Counter to track how many resets have been caused by the Watchdog
22025–22026	Http Push SSL Acquires	Statistical counts of connections, disconnections and forced disconnects when the DXMR90-4K creates a connection using SSL/TLS (Encrypted connections)
22027–22028	Http Push SSL Releases	
22029–22030	Http Push SSL Forced Releases	
22031–22032	Http Push Attempts	Statistical counts of connections, disconnections and forced disconnects when the DXM controller creates a connection using HTTP non-encrypted
22033–22034	Http Push Successes	
22035–22036	Http Push Failures	
22037–22038	Http Push Last Status	Last DXMR90-4K push status 0 = Initial state, no push attempt as finished yet 1 = Attempt complete 2 = Attempt aborted

Continued on page 20

Continued from page 19

Registers	Definition	
22055–22056	Alarms, smtp, attempts	Email attempts
22057–22058	Alarms, smtp, fails	Email failures
22100	Number of read maps in default	Read Map statistics
22101	Number of read map successes	
22102	Number of read map timeouts	
22103	Number of read map errors	
22104	Read map success streak	
22105	Number of write map successes	Write Map statistics
22106	Number of write map timeouts	
22107	Number of write map errors	
22108	Write map success streak	
22109	Number of passthrough successes	API message passing statistics
22110	Number of passthrough timeouts	
22111	Number of passthrough errors	
22112	Passthrough success streak	
23000	Read map success count	Read/Write maps statistics
24000	Write map success count	
25000	Read map timeout count	
25000	Write map timeout count	
27000	Read map error count	
28000	Write map error count	
29000	Read map success streak	
30000	Write map success streak	
31000	Read map is in default	

TCP Client Stats—The "x" represents the socket 0 through 2. The flex socket is not used. This range repeats for the next socket.

TCP client statistics

Register	Definition
2x001	Socket x connection attempts (20001 is the first socket, 21001 is the second socket...)
2x003	Socket x connections
2x005	Socket x disconnections
2x007	Socket x transmits
2x009	Socket x receives
2x011	Socket x resolver attempts (reserved)
2x013	Socket x resolvers (reserved)
2x015–2x020	Reserved
2x021	Socket x Rule 0 transmits
2x023	Socket x Rule 0 receives
2x025	Socket x Rule 0 timeouts

Continued on page 21

Continued from page 20

Register	Definition
2x027	Socket x Rule 0 broadcasts
2x029	Reserved
2x031	Socket x Rule 1 transmits
2x033	Socket x Rule 1 receives
2x035	Socket x Rule 1 timeouts
2x037	Socket x Rule 1 broadcasts
2x039	Reserved

Reset Codes—The reset codes are in virtual register 11015 and define the condition of the last restart operation.

Reset codes

Reset Code	Definition
0	Undefined
1	Unknown
2	General
3	Brownout
4	Watchdog
5	User
6	Software
7	Return from backup mode

Connecting to Remote IO-Link Devices

Use the DXMR90-4K's IO-link ports for connecting IO-Link devices and digital sensors, lights, and actuators. All ports use a 4-pin M12 female connector to connect to remote devices. No additional wiring is required if the sensors use compatible wiring.

Ports 1-4 female connector

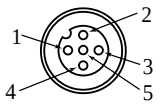
Port 1-4 5-pin M12 Connector (female)	Pin	Wire Color	Description
	1	Brown (bn)	18 V DC to 30 V DC
	2	White (wh)	I/Q (digital in-out)
	3	Blue (bu)	DC common (GND)
	4	Black (bk)	C/Q (communications/digital in-out)
	5	Gray (gy)	Not used/reserved

The basic communications parameters for the IO-Link ports are set in the DXM Configuration Software and are saved in the XML configuration file. Each port can have unique settings.

RTU Configuration screen for ports 1-4

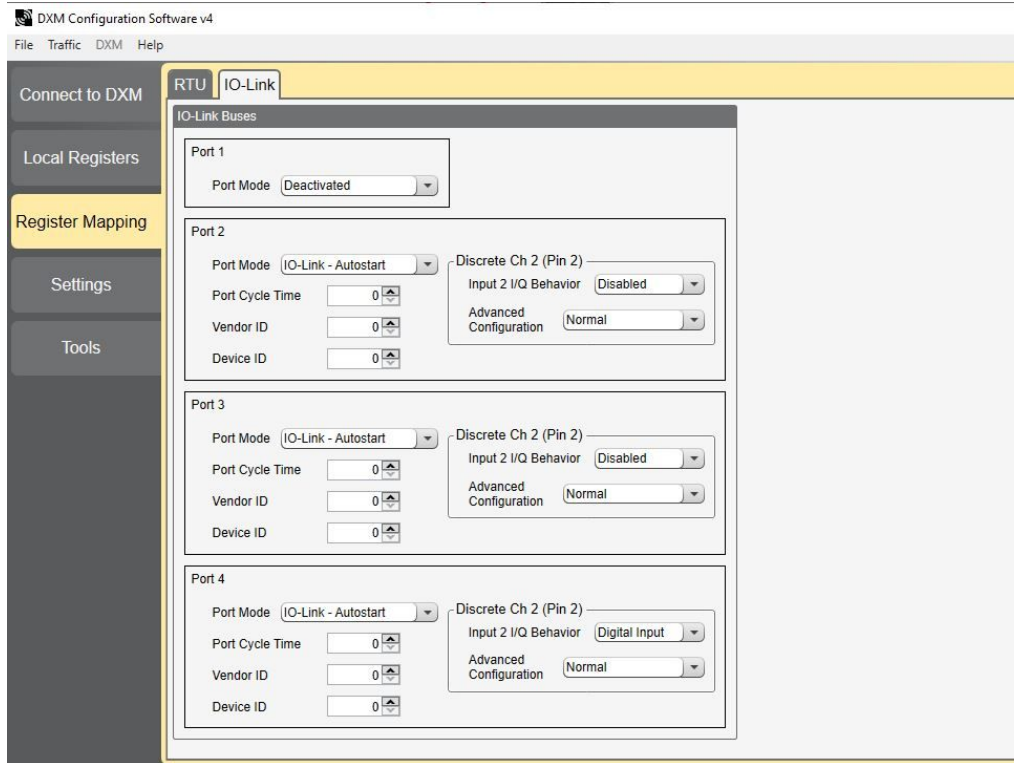

The DXM Configuration has a special tab for configuring the port settings on the IO-link master. To access go Register Mapping--> IO-link Configuration. In this section you can configure the port settings of the IO-link Master.

The operating mode can be configured for any port on the IO-Link master. The following modes can be used:

Deactivated

Use deactivated mode for any unused IO-link master ports if a device is not connected.

IO-Link Manual

The IO-Link master only connects IO-Link devices that have a certain vendor ID and device ID (1: IOL_MANUAL).

This mode is also required to for the Backup and Restore or Restore function.

IO-Link Autostart

The IO-Link master connects to every connected IO-Link device (2: IOL_AUTOSTART).

Digital Input

The IO-Link port functions as a standard digital input (3: DI_C/Q).

Digital Output

The IO-Link port functions as a standard digital output (4: DO_C/Q).

For more information on the port settings of the DXMR90-4K IO-Link Master, refer to the IO-Link Master Data Reference Guide.

Replacing an IO-Link Device During Operation (Backup/Restore Mode)

Replacing an IO-Link device during operation is common, and inadvertent changes to device settings can cause operational problems and down-times. Operating personnel without special knowledge or tools can replace IO-Link devices quickly and without errors.

When the backup function of the IO-Link master is used, the IO-Link master automatically provides the saved parameters to the new device after replacement. This makes IO-Link device replacement seamless in IO-Link applications. Another common industry term for this function is *data storage mode*.

. Backup+Restore Mode

If a port on the IO-Link master is set to Backup+Restore, then the new device added to the IO-Link port takes in the same device configuration as the device that was just replaced, as the IO-Link master had stored the last configuration change by a backup (3: Type compatible Device V1.1, Backup + Restore).

. Restore

If the port on the IO-Link master port is set to Restore, then the new device takes in the configuration according the settings saved in the master at the time of the last backup. Because possible configuration changes were not saved in the master, a different behavior from the previous one before the replacement may occur (4: Type compatible Device V1.1, Restore).

Configuring Connected Banner IO-Link Devices

Banner's IO-Link Configuration Software offers an easy way to configure Banner IO-Link masters and Banner IO-Link devices, offering users control of master and device configuration.

The easy-to-use software provides a variety of tools and works with the DXM110-8K, DXMR90-4K, R90C-4K-MQ, and R45C-2K-MQ IO-Link Masters. Configure Banner IO-link Masters and IO-Link devices using the free IO-Link Configuration Software, available for download on the product page for the DXMR110-8K at: <https://www.bannerengineering.com/us/en/products/part.814332.html>.

Like the DXM Configuration Software, this software enables you to configure port settings for the DXMR90-4K. It also has the ability to configure Banner IO-link Devices connected to the DXMR90-4K and to configure the IP address settings of the DXMR110-8k and DXMR90-4K IO-Link masters.

For instructions on how to use the software to configure IO-link port settings and IO-link devices connected to the IO-link master, use the IO-Link Configuration Software Instruction Manual, available from the software by going to **Help > Help File**. The IO-link Configuration Software Instruction manual can also be downloaded directly on the product page for the DXMR90-4K.

IO-Link configuration start page



IO-Link configuration to select Ethernet

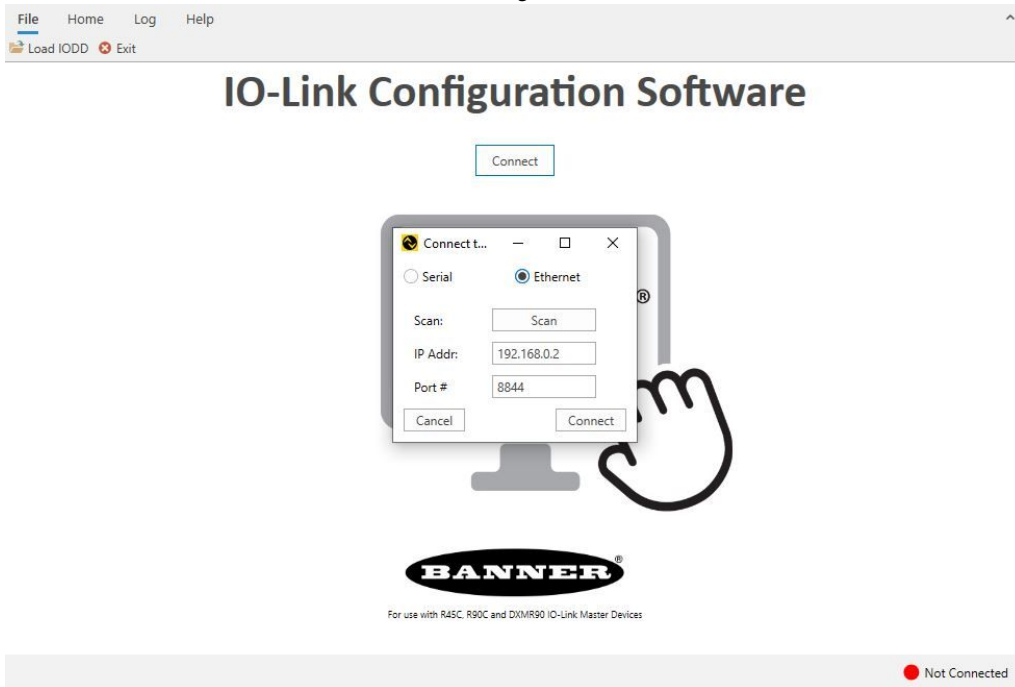

Connecting to Remote Modbus Devices

In addition to the 4 IO-link ports, the DXMR90-4K has one Modbus Master Port, the female M12 port uses a 4-pin M12 female connector to connect to remote devices. No additional wiring is required if the sensors use compatible wiring.

Port 0 female connector

Port 0 4-pin M12 Connector (female)	Pin	Wire Color	Description
	1	Brown (bn)	18 V DC to 30 V DC
	2	White (wh)	RS485 / D1 / B / +
	3	Blue (bu)	DC common (GND)
	4	Black (bk)	RS485 / D0 / A / -

The DXMR90-4K can be a Modbus RTU master device to other slave devices and can be a Modbus slave device to another Modbus RTU master. The DXMR90-4K uses female port 0 as a Modbus RTU master port to control external slave devices. All wired devices connected to the master RS-485 port must be slave devices.

- As a Modbus RTU master device, the DXMR90-4K controls external slaves connected to female M12 port 0
- As a Modbus RTU slave device, the DXMR90-4K local registers can be read from or written to by another Modbus RTU master device via port 0.

The Modbus RTU slave connection, port 0, is controlled by another Modbus master device that is not the DXMR90-4K. The slave port is used by an external Modbus master device that will access the DXMR90-4K as a Modbus slave Device. Use the DXM Configuration Software to define the operational settings for both the Modbus RTU master port 0 and the Modbus RTU slave port 0.

The basic communications parameters for the RS-485 ports are set in the DXM Configuration Software and are saved in the XML configuration file.

Define an RTU Read Rule

Follow these steps to create a new read rule.

This example creates a read rule to read six registers (address 1 through 6), from Port 0 Modbus Slave 4. The results are stored in the Local Registers 12001 through 12006.

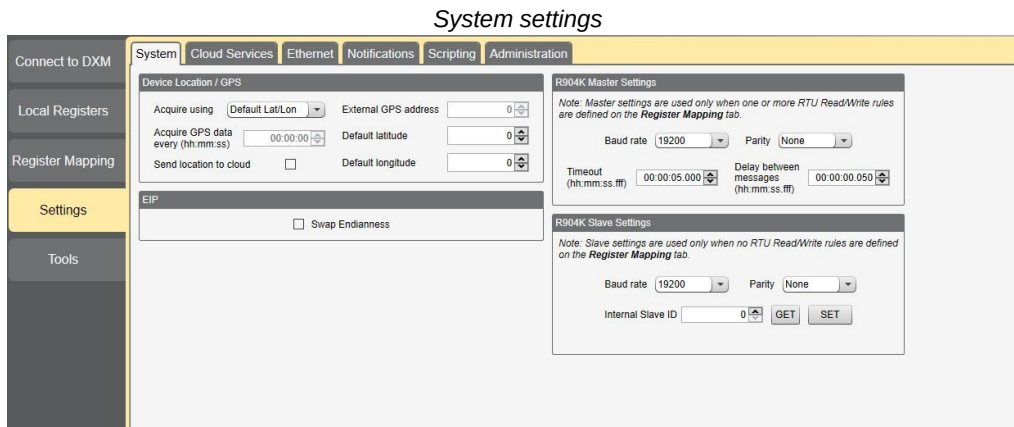

1. Go to **Settings** > **System** to define the port settings to be compatible with the connected devices.
 - a. Verify the **Baud rate** and **Parity** match that of the connected Modbus slave devices.
 - b. The timeout controls how long the DXMR90 waits before determining a command has failed to send. Set the timeout based on your specific application requirements.
 - c. The **Delay between messages** defines the minimum wait time between resending another command. Set the delay based on your specific application requirements.

The **Baud rate** is defined for both the Modbus master and slave; settings include 19200 (default), 1200, 2400, 9600, 38400, 57600, and 115200. The **Delay between messages** applies to the Modbus master port and sets the minimum wait time from the end of a Modbus transaction to the beginning of the next Modbus transaction. **Parity** is defined for both the Modbus master and slave; settings include None (default), odd, even, space, and mark. **Timeout** applies to the Modbus master port and covers the expected time for messages to be sent throughout the wireless network. For the DXM, the Timeout parameter is the maximum amount of time the DXM should wait after a request is sent until the response message is received from the Modbus slave device.

2. From the **Register Mapping** > **RTU** > **RTU Read** screen, click **Add Read Rule**.
3. Click the arrow next to the name to display the parameters.
4. Name your rule.
5. Select the slave ID.
6. Select how many registers to read, and the beginning register.
7. Define the register type, how often to read the register, and any other appropriate parameters.
8. If necessary, select the error condition. For this example, if the read function fails after three attempts, the read rule writes 12345 to the DXM local registers. Notice the list of local register names this read rule is using.

Example Read Rules Configuration

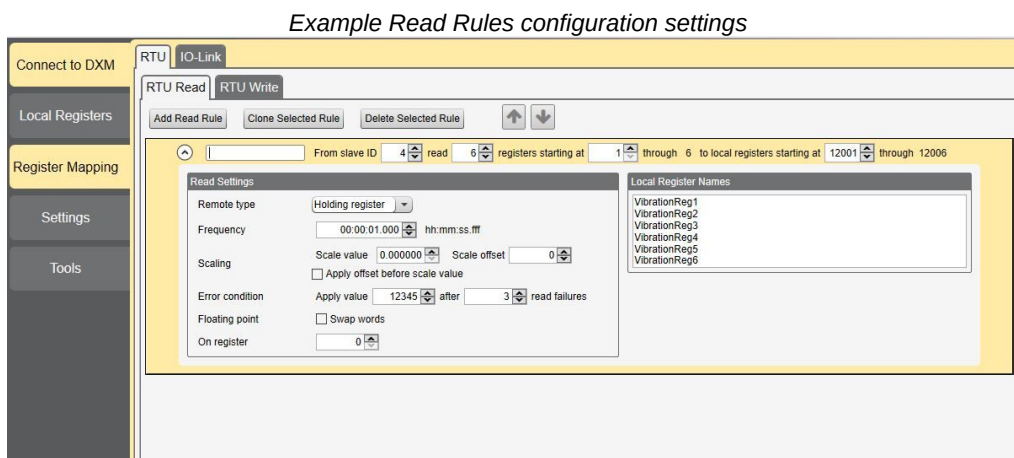

Blank page

Chapter Contents

Set the Controller to use Authentication	27
Register Flow and Configuration	28
EtherNet/IP™ Configuration	29
Commissioning and Connecting IO-Link Devices to a Rockwell PLC with Add-On Instructions.....	30
Push Retries.....	31

Chapter 5 Configuration Instructions

Set the Controller to use Authentication

The DXMR90-4K can be configured to send login and password credentials for every HTTP packet sent to the webserver. This provides another layer of security for the webserver data.

Configuration requires both the webserver and the DXMR90-4K to be given the same credentials for the login and password. The webserver authentication username and password are not stored in the XML configuration file and must be stored in the DXMR90-4K.

1. From within the DXM Configuration Software, go to the **Settings > Cloud Services** screen.
2. In the upper right, select **Show advanced settings**.
3. Define the username and password in the **Web Server Authentication** section of the screen.

Web Server Authentication screen

The first time you select **Require Authentication**, a pop-up box appears with additional instructions. Since the data is not stored in the XML configuration file, it is hidden from view of the DXM Configuration Software.

4. Click on **Send Authentication**.
The controller must be connected to the PC for this operation to succeed.
The data transmits directly to the DXMR90-4K's non-volatile memory. If successful, a pop-up window appears, asking to reboot the device.
5. Select **Yes** to reboot the device.

Set the Web Services to Use Authentication

1. At the Banner Cloud Data Services website, go to **Settings > Sites**.
2. To edit the site settings, click **Edit** on the line of the site name.

Settings > Sites screen of the Banner CDS website

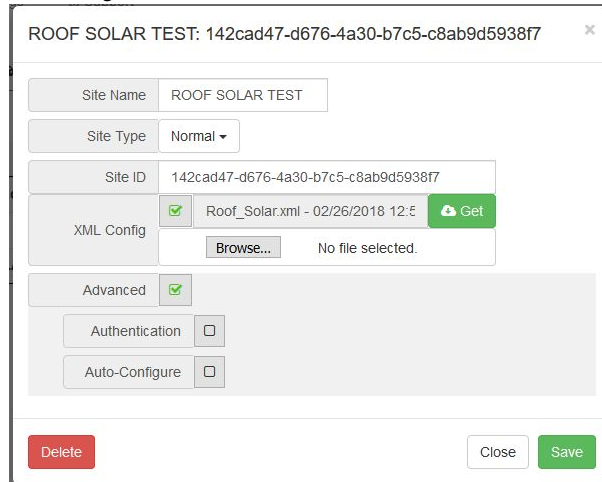

At the bottom of the pop-up window is a checkbox to enable authentication/validation.

3. Enter the same username and password as used in the DXM Configuration Software. The username and password do not need to be a defined user within the Banner Cloud Data Services website.

Controller Configuration Authentication

The DXMR90-4K can be programmed to allow changes to the configuration files only with proper authentication by setting up a password on the **Settings > Administration** screen in the DXM Configuration Software.

With the DXMR90-4K connected to the PC, click **Get Device Status**. The DXMR90-4K status displays next to the button.

Settings > Administration screen

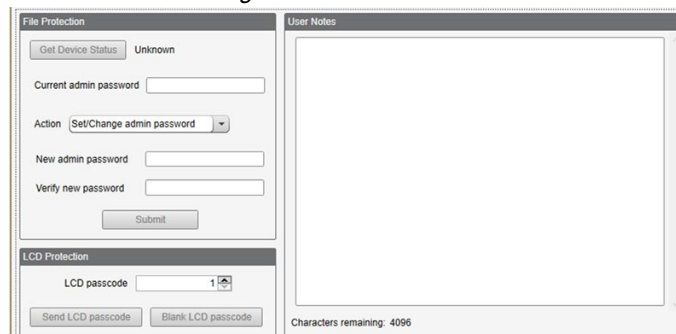

Use the DXM Configuration Software to:

- Set the Admin Password
- Change the Admin Password
- Remove the Admin Password

To change or remove an admin password, the current password must be supplied. The DXMR90-4K must be connected to the PC to change the administration password.

Register Flow and Configuration

The DXMR90-4K register data flow goes through the Local Registers, which are data storage elements that reside within the processor. Using the configuration software, the controller can be programmed to move register data from the Local Register pool to remote devices or the I/O base.

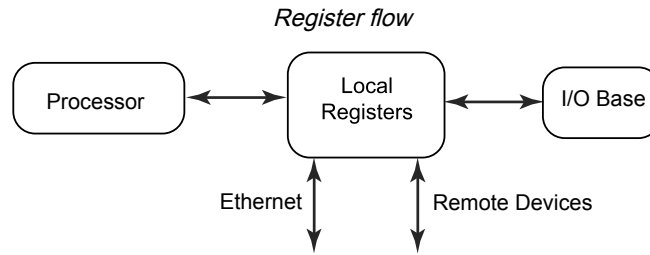

Basic Approach to Configuration

When programming an application in the DXMR90-4K, first plan the overall data structure of the Local Registers. The Local Registers are the main storage elements in the DXMR90-4K. Everything goes into or out of the Local Registers.

1. In the DXM Configuration Software, name the Local Registers to provide the beginning structure of the application.
2. Configure the read/write rules to move the data. The Read/Write rules are simple rules that move data between devices (Nodes, Modbus servers, sensors, etc) and the Local Registers.
3. Most applications require the ability to manipulate the Local Register data, not just move data around. Use the **Action rules** to make decisions or transform the data after the data is in the Local Registers. Action rules can apply many different functions to the Local Register data, including conditional statements, math operations, copy operations, or trending.
4. To perform scheduled events in Local Registers, go to the **Scheduler** screen in the DXM Configuration Software. These rules provide the ability to create register events by days of the week. The scheduler can also create events based on sunrise or sunset.

Troubleshooting a Configuration

View Local Registers using the **Local Registers** > **Local Registers in Use** screen of the configuration software.

When a configuration is running on the DXMR90-4K, viewing the Local Registers can help you to understand the application's operation. This utility can also access data from remote devices and the LED registers.

Saving and Loading Configuration Files

The DXM Configuration Software saves its configuration information in a XML file. Use the **File** menu to Save or Load configuration files.

Save the configuration file before attempting to upload the configuration to the DXMR90-4K. The DXM Configuration Software uploads the configuration file saved on the PC to the DXMR90-4K; it will not send the configuration loaded in the tool.

Uploading or Downloading Configuration Files

The DXMR90-4K requires a XML configuration file to become operational. To upload or download configuration files, connect a computer to the DXMR90-4K using the Ethernet port. Then use the **Upload Configuration to Device** or **Download Configuration from Device** under the **Device** menu.

EtherNet/IP™ Configuration

The DXMR90-4K can be configured to send/receive local register data to and from an EtherNet/IP™⁽¹⁾ host. EDS (Electronic Data Sheet) files allow users of the EtherNet/IP protocol to easily add a Banner DXM device to the PLC. Download the EDS files from the Banner website.

- DXM EDS Configuration File (for PLCs) (p/n [b_4205242](#))
- DXM EIP Config File for DXM Controller with Internal Gateway (Models: DXM1xx-BxR1, DXM1xx-BxR3, and DXM1xx-BxCxR1) (p/n [194730](#))

Configuring the Host PLC

On the host PLC, install the DXMR90-4K using an EDS file or by using the following parameters:

- Assembly1: Originator to DXM = Instance 112, 456 bytes (228 words)

⁽¹⁾ EtherNet/IP is a trademark of Rockwell Automation.

- Assembly2: DXM to Originator = Instance 100, 456 bytes (228 words)

The Originator is the host PLC system, and the DXM is the DXMR90-4K. The host system sees the DXMR90-4K as a generic device with the product name of Banner DXM (ProdType: 43 - Generic Device, ProdName: Banner DXM, Integer Type - INT).

IMPORTANT: Do not set the Requested Packet Interval (RPI) any faster than 150 ms.

Configuring the Controller

Use the configuration software to define the **Protocol conversion** for each local register to be **EIP Originator › DXM** or **EIP DXM › Originator** from the **Edit Register** or **Modify Multiple Register** screens.

Define a DXM local register as **EIP Originator › DXM** when the host PLC (Originator) will send data to the DXMR90-4K local register (DXM).

Define a DXM local register as **EIP DXM › Originator** when that register data will be sent from the DXMR90-4K (DXM) to the host PLC (Originator).

Data from an EIP controller in assembly instance 112 is data destined for the DXMR90-4K local registers. The PLC is normally configured for INT or UINT data transfer. This allows for a seamless transfer of data.

EIP Assembly Instance 112 (16-bit)			DXM Local Registers	
Adrs	Data		Adrs	Data
0	1122		1	1122
1	3344		2	3344
2	5566		3	5566
3	7788		4	7788
4	9900		5	9900

Data from the DXMR90-4K local registers is sent to the EIP controller using assembly instance 100. Each local register in the DXMR90-4K defined as **EIP DXM › Originator** is collected in numerical order and placed into the data buffer destined for assembly instance 100. DXM local registers are capable of 32-bits, but only the lower 2-bytes (16-bits) for each local register are transferred.

EIP Assembly Instance 100 (16-bit)			DXM Local Registers	
Adrs	Data		Adrs	Data
0	1122		11	1122
1	3344		12	3344
2	5566		13	5566
3	7788		14	7788
4	9900		15	9900

Commissioning and Connecting IO-Link Devices to a Rockwell PLC with Add-On Instructions

An Add-On-Instruction or AOI is a feature introduced by Rockwell Software in version 16 of RSLogix 5000 programming software. An AOI enables a user to develop and package PLC code in user-defined instructions that is reused throughout their program.

Banner has developed three types of IO-Link related Add On Instruction (AOI) files for use with the Logix Designer software package from Rockwell Automation.

Process Data AOIs (v2)—These files can be used alone, without the need for any other IO-Link AOIs. The job of a Process Data AOI is to intelligently parse out the Process Data word(s) into separate pieces of information. All that is required to make use of this AOI is an EtherNet/IP connection to the IO-Link Master and knowledge of where the Process Data registers are located for each port.

Parameter Data AOIs (v2.1)—These files require using an associated IO-Link Master AOI. The job of a Parameter Data AOI, when working in conjunction with the IO-Link Master AOI, is to provide quasi-realtime read/write access to all IO-Link parameter data in the sensor. Each Parameter Data AOI is specific to a given sensor.

IO-Link Master AOIs (v2.1)—These files require the use of one or more associated Parameter Data AOIs. The job of an IO-Link Master AOI is to translate the desired IO-Link read/write requests, made by the Parameter Data AOI, into the format a specific IO-Link Master requires. Each IO-Link Master AOI is custom-made for a given brand of IO-Link Master. Add and configure the relevant Banner IO-Link Master AOI in your ladder logic program first; then add and configure Banner IO-Link Device AOIs as desired, linking them to the Master AOI as shown in the relevant AOI documentation.

Instructions for using the DXMR90-4K AOI can be found on the DXMR90-4K product page on the Banner website.

Add-on instructions for different Banner IO-link devices can be downloaded on the Banner website. Included in the download, will be PDF instructions for how to use the files.

Example AOIs listed on the Banner Engineering product page for the Q4X Series Sensor

PLC SUPPORT FILES		DATE	TYPE	SIZE	
	Q4X IO-LINK AOIS	8 NOV 2022	AOI	16.3MB	
	THICKNESS MEASUREMENT AOI	6 AUG 2019	AOI	540K	
	Q4X SIEMENS FUNCTIONS	14 FEB 2022	SIEMENS FUNCTIONS	2.3MB	
	THICKNESS SIEMENS FUNCTION BLOCK	6 AUG 2019	SIEMENS FUNCTIONS	553K	

In the Logix Designer software, you can import the Add-On Instructions.

Import Add-On Instructions

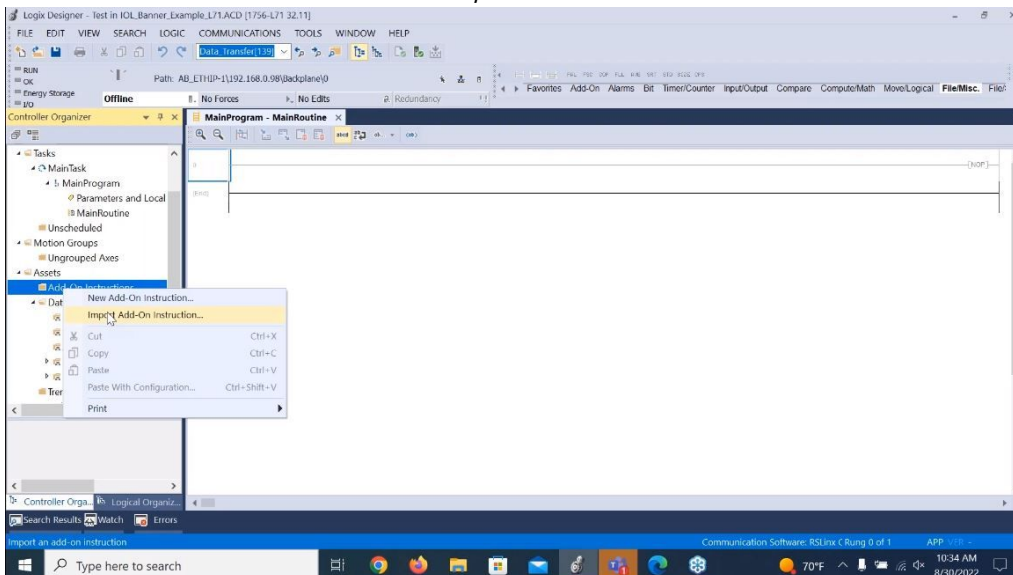

Push Retries

Ethernet—The DXMR90-4K can be configured to send register data packets to a webserver. When the Ethernet communications path is not operating, the DXMR90-4K retries the send procedure. With an Ethernet-based network connection, the DXMR90-4K retries a message five times. The five retry attempts immediately follow each other. After all attempts are exhausted, the register data packet is lost. At the next scheduled time, the DXMR90-4K attempts to send only the new data.

Any past data that the DXMR90 was unable to push is lost and cannot be recovered. Using SSL on Ethernet will have no retries.

Event/Action—Event-based pushes caused by Action rules sent using email follow the same process when failures occur, based on the network connection.

Email—There are no retries for emails that fail to be sent from the DXMR90-4K.

Chapter Contents

General Station Description Markup Language File	33
DXM PROFINET IO Data Model	33
Configure the DXM Controller for a PROFINET IO Connection	33
Slots and Modules for DXM PROFINET	34
Configuration Instructions	12

Chapter 6 PROFINET®

PROFINET is a data communications protocol for industrial automation and processes. PROFINET IO defines how controllers (IO controllers) and peripheral devices (IO devices) exchange data in real-time. PROFINET® is a registered trademark of PROFIBUS Nutzerorganisation e.V. and the standard is maintained by PROFIBUS & PROFINET International (PI), an organization headquartered in Karlsruhe, Germany.

Only the DXMR90, DXM700, DXM1000, and DXM1200 Controller models support PROFINET IO.

General Station Description Markup Language File

A PROFINET General Station Description (GSD) file is a description of an IO device provided by the device manufacturer in an XML format (GSDML.xml).

The GSD file is a standardized way of describing the device information to engineering tools and the IO controller and can work across a variety of tools as a standard set of device information.

DXM PROFINET IO Data Model

The PROFINET IO data model is based on the typical, expandable field device that has a backplane with slots. Modules have different functionalities.

Modules are plugged into slots. In the PROFINET IO data model, Slot 0, Subslot 1 is reserved for the Device Access Point (DAP) or network interface.

Configure the DXM Controller for a PROFINET IO Connection

To use PROFINET, follow these instructions.

1. Using the DXM Configuration Software, go to the **Settings > Ethernet** screen.
2. Select **Enable PROFINET**.
3. Save the configuration file and upload it to the DXM Controller (see "[Save and Upload the Configuration File](#)" on page 15).

After PROFINET is enabled, the IP address for the DXM Controller is controlled by the PROFINET host.

The PROFINET data type and data size to/from the DXM Controller is configurable. The PROFINET data is processed from the Local Register of the DXM Controller.

Configure the IO-Link ports in the XML according to the modules selected for each port.

Save and Upload the Configuration File

After making any changes to the configuration, you must save the configuration files to your computer, then upload it to the device.

Changes to the XML file are not automatically saved. Save your configuration file before exiting the tool and before sending the XML file to the device to avoid losing data. If you select **DXM > Send XML Configuration to DXM** before saving the configuration file, the software will prompt you to choose between saving the file or continuing without saving the file.

1. Save the XML configuration file to your hard drive by going to the **File > Save As** menu.
2. Go to the **DXM > Send XML Configuration to DXM** menu.

Status indicator bar

Connected 192.168.0.1	VibelQ_DXR90_V2.xml	Application Status	
Connected 192.168.0.1	VibelQ_DXR90_V2.xml	Application Status	
Not Connected	VibelQ_DXR90_V2.xml	Application Status	

- If the Application Status indicator is red, close and restart the DXM Configuration Tool, unplug and re-plug in the cable and reconnect the DXM to the software.
 - If the Application Status indicator is green, the file upload is complete.
 - If the Application Status indicator is gray and the green status bar is in motion, the file transfer is in progress.
- After the file transfer is complete, the device reboots and begins running the new configuration.

Slots and Modules for DXM PROFINET

There are ten slots to accommodate the DXM Controller data.

Slots for input and output values

Values	Maximum Data Size
Input values	1440 bytes
Output values	1440 bytes

Slot 1 - Input (DXM --> PLC)

Module ID	Submodule ID	Module	Size (bytes)	Register Start	Register End	Direction
0x44	0x01	Banner IO-Link Master Info	9	1	3	Input
				6	6	
				123	123	

It is important to note that the module placed in slot 2 corresponds to Port 1; the module placed in slot 3 corresponds to Port 2; the module placed in slot 4 corresponds to port 3. etc.

For the DXMR90-4K IO-Link Master device, slots 6 through 9 are unused.

If the IO-Link In/Out process data modules (all except digital input and output) are used, the attached IO-Link device **must have PDI and PDO size less than or equal to the number of data bytes allowed in the module. Data transfers will not be applied otherwise.** For example, plugging in the 16/16 byte module to a slot corresponding to a device that has 22 bytes of PDO results in an error. Process data sent from the PLC to DXM will not be applied.

Slots 2-9 (1 per IO-link port)

Module ID	Submodule ID	Module	Size (bytes)	Register Start	Register End	Direction
0x45	0x01	IO-Link In/Out 32/32 Byte + Status	36	x001	x017	Bidirectional
				x506	x507	
			46	x051	x067	
				x851	x859	
0x46	0x01	IO-Link In/Out 16/16 Byte + Status	20	x001	x009	Bidirectional
				x506	x507	
			30	x051	x059	
				x851	x859	
0x47	0x01	IO-Link In/Out 8/8 Byte + Status	12	x001	x005	Bidirectional

Continued on page 35

Continued from page 34

Module ID	Submodule ID	Module	Size (bytes)	Register Start	Register End	Direction
				x506	x507	
			22	x051	x055	
				x851	x859	
0x48	0x01	IO-Link In/Out 4/4 Byte + Status	8	x001	x003	Bidirectional
				x506	x507	
			18	x051	x053	
				x851	x859	
0x49	0x01	IO-Link In/Out 2/2 Byte + Status	6	x001	x002	Bidirectional
				x506	x507	
			16	x051	x052	
				x851	x859	
0x4A	0x01	IO-Link In/Out 1/1 Byte + Status	5	x001	x002	Bidirectional
				x506	x507	
			15	x051	x052	
				x851	x859	
0x4B	0x01	Digital Output	5	x051	x051	Output Module
				x851	x851	
				x853	x853	
				x858	x858	
0x4C	0x01	Digital Input	2	x001	x001	Bidirectional
			4	x051	x051	
				x851	x851	
				x853	x853	
				x858	x859	

Slot 10 (ISDU)

Module ID	Submodule ID	Module	Size (bytes)	Register Start	Register End	Direction
0x4D	0x01	ISDU 190 Byte + Status	196	351	442	Bidirectional
			196	200	291	
0x4E	0x01	ISDU 80 Byte + Status	86	351	396	
			86	200	245	

Example Configuration

Slot	Module	Description
Slot 1	Banner IO-Link Master Info	Vendor ID, Device ID, Number of Supported Channels, and Firmware Version information
Slot 2	IO-Link In/Out 32/32 Byte + Status	Get/send IO-Link PDI/PDO for IO-Link device on Port 1 with PD Size between 17 and 32 bytes
Slot 3	IO-Link In/Out 16/16 Byte + Status	Get/send IO-Link PDI/PDO for IO-Link device on Port 2 with PD Size between 9 and 16 bytes
Slot 4	IO-Link In/Out 2/2 Byte + Status	Get/send IO-Link PDI/PDO for IO-Link device on Port 3 with PD Size between 1 and 2 bytes

Continued on page 36

Continued from page 35

Example Configuration		
Slot	Module	Description
Slot 5	Digital Output	Use SIO Output mode on Port 4
Slot 10	ISDU 190 Byte + Status	ISDU read/write access for all ports in IO-Link mode

Configuration Instructions

Install the GSD File

Although these instructions are specific for the Siemens TIA Portal (v14) software, you may use these instructions as a basis for installing the GSD file into another controller.

1. Download the GSD file from www.bannerengineering.com.
2. Launch the Siemens TIA Portal (v14) software.
3. Click **Open existing project**.
4. Select a project and open it.
5. After the project is uploaded, click **Devices & networks**.

Devices and networks screen

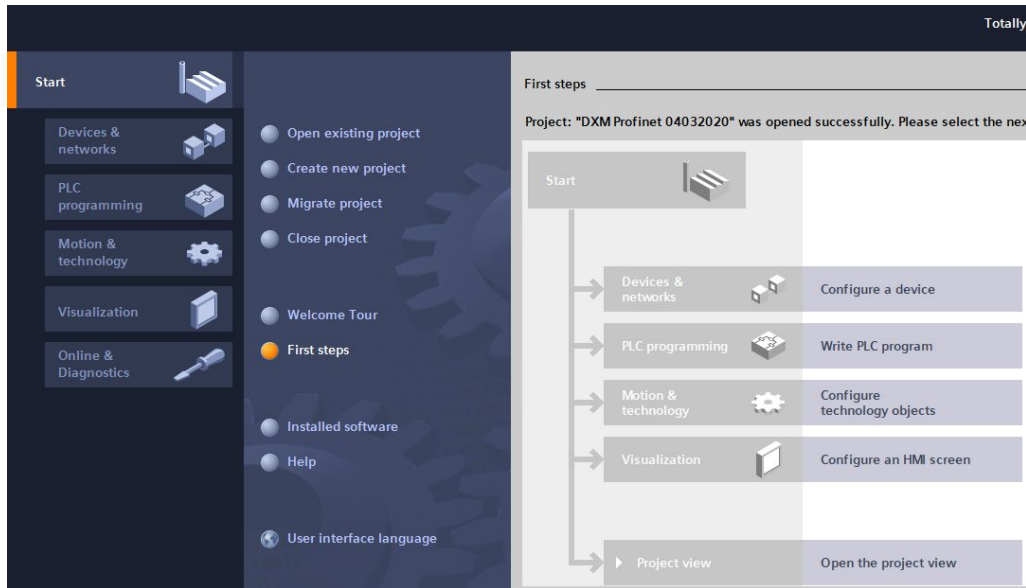

6. Click **Configure networks**.

Configure networks screen

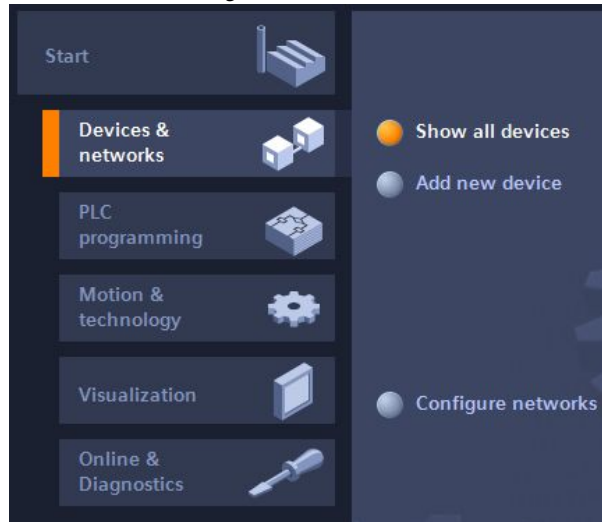

7. Click **Options** and select **Manage general station description file (GSD)**.
The **Install general station description file** window opens.
8. Click the **More options (...)** icon to the right of the **Source path** field and browse to the location the DXM GSD file was downloaded to.
9. Select the DXM GSD file.
10. Click **Install**.

Hardware catalog

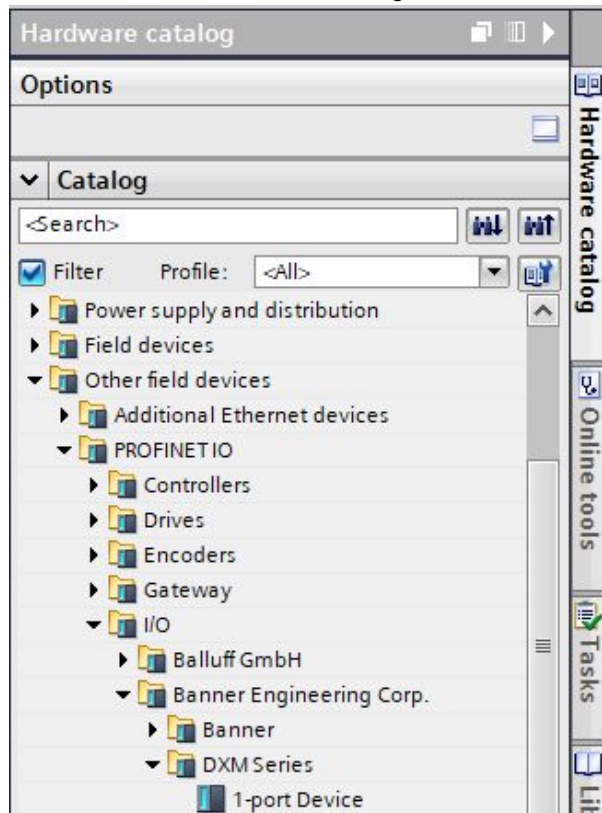

The system installs the DXM GSD file and places it in the **Hardware catalog**. In the example, the DXM GSD file is located under **Other field devices** > **PROFINET IO** > **Banner Engineering Corp.** > **Banner**.

If the DXM GSD file does not install properly, save the log and contact Banner Engineering Corp.

Change the Device IP Address

Follow these instructions to change the IP address of the DXM device using the Siemens TIA Portal (v14) software. Use these instructions as a basis if you are using another controller (PLC).

1. Launch the Siemens TIA Portal (v14) software.
2. Click **Open existing project**.
3. Select a project and open it.
4. Click **Devices & networks**.

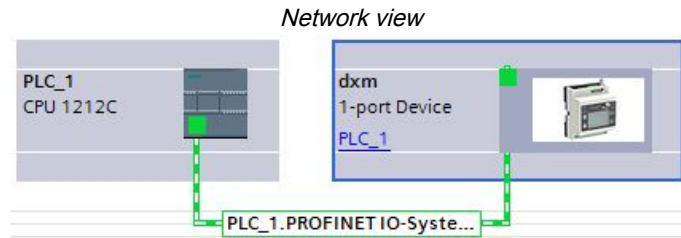

The **Network view** displays.

5. Double-click on the DXM icon to open the **Device view** screen.
6. Click on the DXM icon in the graphic area of the **Device view** screen.
The **Module properties** window displays and the module can now be configured.
7. Click **Properties**.
8. Click **General**.
9. Select **PROFINET Interface > Ethernet addresses**.

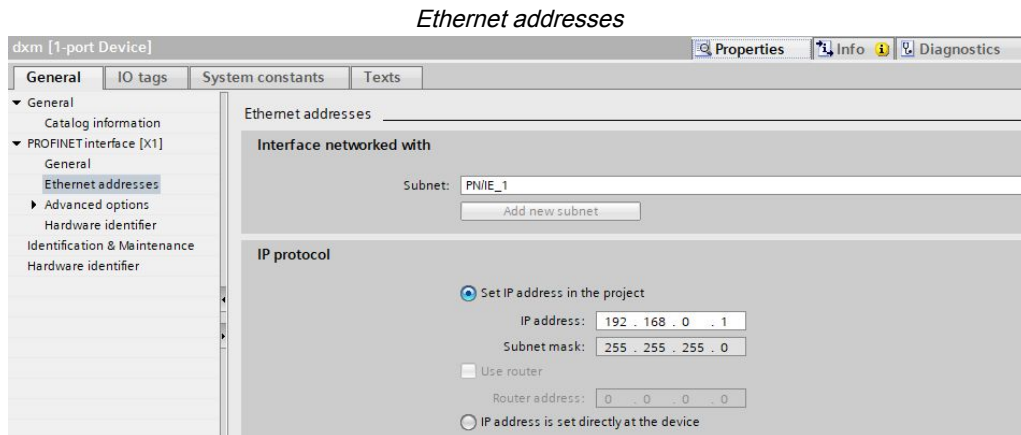

10. Select **Set IP address in the project**.
11. Enter the IP address.
12. Right-click on the device icon and select **Online & diagnostics**.

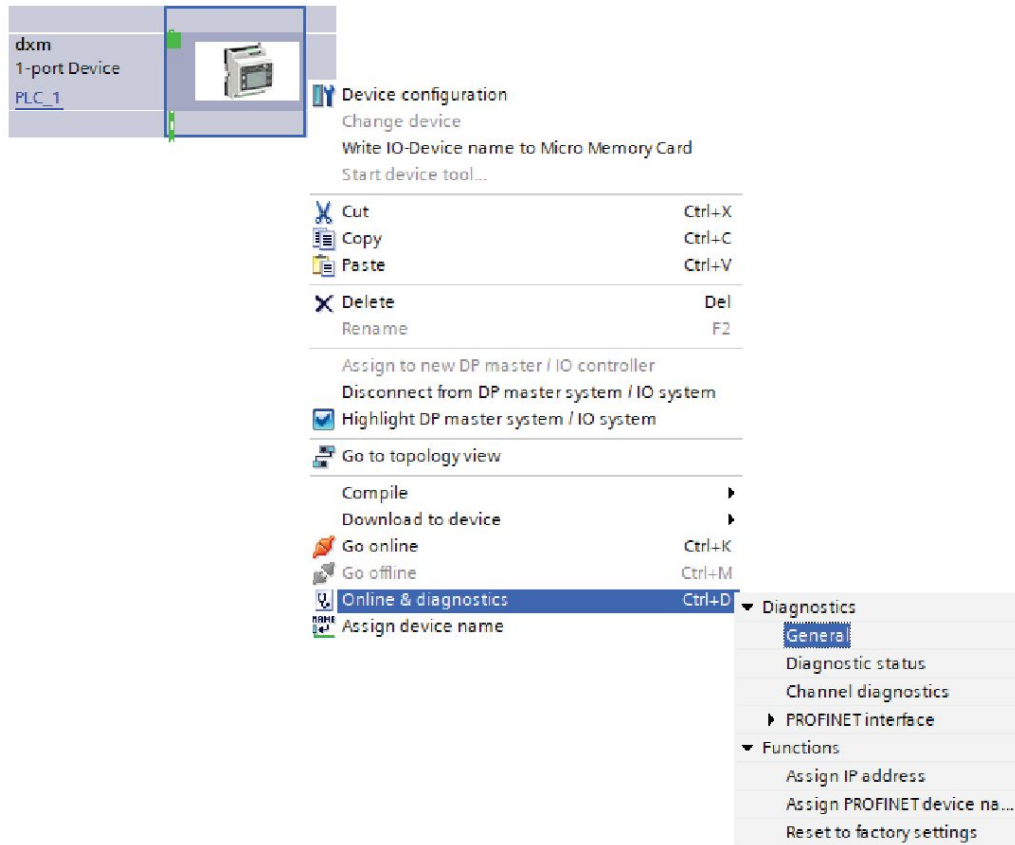
Online & diagnostics menu and screen

The **Online & diagnostics** windows displays.

13. Select **Assign IP address** under **Functions**.
14. Click **Accessible devices**.
The Select device window searches the network for available devices.
15. Determine the device to be adjusted via the MAC address and select it.
16. Click **Apply**.
The IP address for the device is updated.
17. Click **Assign IP address** to complete the step.
This step is completed for every device.

By default, each DXM shipped from the factory is assigned the IP address 192.168.0.1.

Immediately after the PROFINET protocol is enabled, the DXM has an IP address of 0.0.0.0. We recommend using the TIA Portal to give the DXM an IP address so that the address is saved in the unit. When the PLC powers up, this IP address is accessible. The PLC can change the IP address if it is configured to do so.

If the PLC assigns the DXM IP address (for example, using the Set IP address in the project option in Siemens TIA Portal), the DXM receives the specified address, but only after the program has been loaded into the PLC and is running. If the DXM is restarted after it was discovered and configured by the PLC, the DXM retains the IP address that was assigned to it using the LCD or software until after the PLC discovers the DXM and assigns it the specified address again. However, if this address is different than what is specified in the PLC, the DXM reverts to the address specified in the PLC after the PLC becomes active again.

These configuration options conform to the PROFINET standard.

Change the Device Name

Follow these instructions to change the name of the DXM using the Siemens TIA Portal (v14) software. Use these instructions as a basis if you are using another controller (PLC).

1. Open a project and click on **Devices & networks**.

The Network view displays.

2. Right-click on the DXM icon and select **Assign device name**.
The **Assign PROFINET device name** window displays. The software searches for devices of the same type.
3. Enter the desired name in the **PROFINET device name** field. Note that each name can be used only once.
4. Click **Assign name**.
The device now has a PROFINET name.

Chapter 7 Accessories for the DXMR90-4K

Power Supplies

PSD-24-4—DC Power Supply, Desktop style, 3.9 A, 24 V DC, Class 2, 4-pin M12/Euro-style quick disconnect (QD)

PSDINP-24-06—DC power supply, 0.63 Amps, 24 V DC, with DIN Rail Mount, Class I Division 2 (Groups A, B, C, D) Rated

PSDINP-24-13 —DC power supply, 1.3 Amps, 24 V DC, with DIN Rail Mount, Class I Division 2 (Groups A, B, C, D) Rated

PSDINP-24-25 — DC power supply, 2.5 Amps, 24 V DC, with DIN Rail Mount, Class I Division 2 (Groups A, B, C, D) Rated

PSW-24-1—DC power supply with multi-blade wall plug, 100–240 V AC 50/60 Hz input, 24 V DC 1 A output, UL Listed Class 2, 4-pin female M12 connector

PSWB-24-1—DC power supply with multi-blade wall plug, 100–240 V AC 50/60 Hz input, 24 V DC 1 A output, UL Listed Class 2, barrel jack connector

<p>SMBR90S</p> <ul style="list-style-type: none"> • Stainless steel bracket • 4x M4-07 pemnuts (B) • Includes 2x M4 stainless steel hex head screws and flat washers <p>Hole center spacing: A = 40, B = 20</p> <p>Hole size: A = \varnothing 5</p>	
--	--

4-Pin Threaded M12 Cordsets—Double Ended				
Model	Length	Style	Dimensions	Pinout
MQDEC-401SS	0.31 m (1 ft)	Male Straight/Female Straight		<p>Female</p>
MQDEC-403SS	0.91 m (2.99 ft)			
MQDEC-406SS	1.83 m (6 ft)			
MQDEC-412SS	3.66 m (12 ft)			
MQDEC-420SS	6.10 m (20 ft)			
MQDEC-430SS	9.14 m (30.2 ft)			
MQDEC-450SS	15.2 m (49.9 ft)	Male Right-Angle/Female Straight		<p>Male</p> <p>1 = Brown 2 = White 3 = Blue 4 = Black</p>
MQDEC-403RS	0.91 m (2.99 ft)			
MQDEC-406RS	1.83 m (6 ft)			
MQDEC-412RS	3.66 m (12 ft)			
MQDEC-420RS	6.10 m (20 ft)			
MQDEC-430RS	9.14 m (30.2 ft)			
MQDEC-450RS	15.2 m (49.9 ft)			

Continued on page 42

Continued from page 41

4-Pin Threaded M12 Cordsets—Double Ended				
Model	Length	Style	Dimensions	Pinout
MQDEC-403RR	0.9 m (2.9 ft)	Male Right-Angle/ Female Right-Angle		
MQDEC-406RR	1.8 m (5.9 ft)			
MQDEC-412RR	3.6 m (11.8 ft)			
MQDEC-420RR	6.1 m (20 ft)			

5-Pin Threaded M12 Cordsets—Single Ended				
Model	Length	Style	Dimensions	Pinout (Female)
MQDC1-501.5	0.5 m (1.5 ft)	Straight		
MQDC1-503	0.9 m (2.9 ft)			
MQDC1-506	2 m (6.5 ft)			
MQDC1-515	5 m (16.4 ft)			
MQDC1-530	9 m (29.5 ft)			
MQDC1-560	18 m (59 ft)			
MQDC1-506RA	2 m (6.5 ft)	Right-Angle		<p>1 = Brown 2 = White 3 = Blue 4 = Black 5 = Gray</p>
MQDC1-515RA	5 m (16.4 ft)			
MQDC1-530RA	9 m (29.5 ft)			
MQDC1-560RA	19 m (62.3 ft)			

4-pin M12 D-code to RJ45 Shielded Ethernet				
Model	Length	Style	Dimensions	Pinout (Male)
STP-M12D-406	1.83 m (6 ft)	Straight		<p>1 = White/Orange 2 = Orange 3 = White/Blue 6 = Blue</p>
STP-M12D-415	4.57 m (15 ft)			
STP-M12D-430	9.14 m (30 ft)			

Chapter Contents

Specifications for the DXMR90-4K..... 43
 File System and Archive Process 44
 Update Your DXM Processor Firmware Using the Configuration Software 44
 DXM Support Policy 44
 Contact Us..... 45
 Warnings 45
 Banner Engineering Corp Limited Warranty 46
 47

Chapter 8 Product Support and Maintenance

Specifications for the DXMR90-4K

Supply Voltage

18 V DC to 30 V DC

Supply Protection Circuitry

Protected against reverse polarity and transient voltages

Power Consumption

24 V DC at 100 mA + 200 mA/port = 900 mA maximum

Construction

Connector Body: PVC translucent black

Indicators

- Green/amber: Program status indicators
- Green/amber: Ethernet communications
- Red/green/blue on port 1: IO-Link Port 1 Status
- Red/green/blue on port 2: IO-Link Port 2 Status
- Red/green/blue on port 3: IO-Link Port 3 Status
- Red/green/blue on port 4: IO-Link Port 4 Status

Connections

- Five integral 5-pin M12 female quick disconnect
- One integral 4-pin M12 male quick disconnect
- One integral 5-pin M12 female D-Code quick disconnect

Application Note

When connecting external devices through the DXMR90-4K, it is important not to exceed the maximum current limitations of 3.5 Amps

Communication Hardware (RS-485)

Interface: 2-wire half-duplex RS-485
 Baud rates: 1.2K, 2.4K, 9.6k, 19.2k (default), 38.4k, 57.6K, or 115.2K
 Data format: 8 data bits, no parity, 1 stop bit

Communication Protocols

Modbus® RTU, PROFINET®, Modbus/TCP, EtherNet/IP™
 EtherNet/IP™ is a trademark of ODVA, Inc. Modbus® is a registered trademark of Schneider Electric USA, Inc. PROFINET® is a registered trademark of PROFIBUS Nutzerorganisation e.V.

Security Protocols

TLS, SSL, HTTPS

Digital Inputs (SIO [DI] Mode)

Input Current: 5 mA typical
 ON Voltage/Current: 15 V DC minimum/5 mA minimum
 OFF Voltage: 5 V DC maximum

Digital Outputs (SIO [DO] Mode)

On-Resistance: 120 mΩ typical, 250 mΩ maximum
 Current Limit: 0.7 A minimum, 1.0 A typical, 1.3 A maximum
 Off Leakage Current: -10 µA minimum, 10 µA maximum

IO-Link Baud Rates

COM1: 4.8 kbps
 COM2: 38.4 kbps
 COM3: 230.4 kbps

Operating Conditions

-40 °C to +70 °C (-40 °F to +158 °F)
 90% at +70 °C maximum relative humidity (non-condensing)

Storage Temperature

-40 °C to +80 °C (-40 °F to +176 °F)

Environmental Ratings

For Indoor Use Only
 IP65, IP67, NEMA 1, UL Type 1

Vibration and Mechanical Shock

Meets IEC 60068-2-6 requirements (Vibration: 10 Hz to 55 Hz, 1.0 mm amplitude, 5 minutes sweep, 30 minutes dwell)
 Meets IEC 60068-2-27 requirements (Shock: 30G 11 ms duration, half sine wave)

Certifications



Banner Engineering BV
 Park Lane, Culliganlaan 2F bus 3
 1831 Diegem, BELGIUM



Turck Banner LTD Blenheim House
 Blenheim Court
 Wickford, Essex SS11 8YT
 GREAT BRITAIN

Required Overcurrent Protection

For additional product support, go to www.bannerengineering.com.



WARNING: Electrical connections must be made by qualified personnel in accordance with local and national electrical codes and regulations.

Overcurrent protection is required to be provided by end product application per the supplied table.

Overcurrent protection may be provided with external fusing or via Current Limiting, Class 2 Power Supply.

Supply wiring leads < 24 AWG shall not be spliced.

Supply Wiring (AWG)	Required Overcurrent Protection (A)	Supply Wiring (AWG)	Required Overcurrent Protection (A)
20	5.0	26	1.0
22	3.0	28	0.8
24	1.0	30	0.5

File System and Archive Process

The DXM file system is in a serial EEPROM that stores non-volatile configuration information. The serial EEPROM stores basic data that is required to be non-volatile, including network configuration data, IP address, MAC address, network masks, firewall settings, and authentication information.

The controller XML configuration file created by the DXM Configuration Software is stored in EEPROM. The small section of non-volatile local registers is also stored in EEPROM.

Update Your DXM Processor Firmware Using the Configuration Software

To update your processor firmware using the DXM Configuration Software, follow these instructions.

- Using the DXM Configuration Software version 4 or later, connect to the DXMR90-4K via Ethernet. File loads to the DXMR90-4K will take several minutes.
- On the DXM Configuration Software, go to **Tools > Reprogram > Get Device Information** to verify the current firmware version.
You must load a different version with the same firmware number for the bootloader to operate. Download firmware files from the Banner website.

Example Device Information screen; every device's information will be different

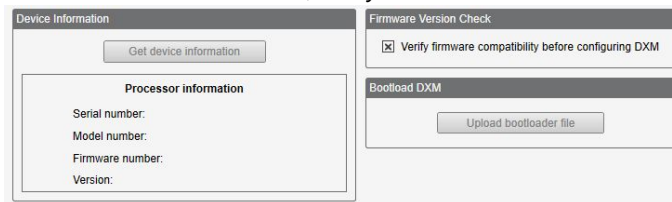

- Under **Tools > Reprogram**, click **Upload bootloader file** to select the firmware file to program.

After the file load is completed, reboot the device by selecting **DXM > Reboot DXM**.

To verify the firmware has been updated, go to **Tools > Reprogram > Get Device Information** and verify the new versions are listed.

DXM Support Policy

The DXM Wireless Controllers are industrial wireless controllers that facilitate Industrial Internet of Things (IIoT) applications. As a communications gateway, it interfaces local serial ports, local I/O ports, and local ISM radio devices to the Internet using either a cellular connection or a wired Ethernet network connection. In a continuing effort to provide the best operation for the DXM, stay connected with Banner Engineering Corp to hear about the latest updates through the Banner website. Create a login today to stay informed of all Banner product releases.

Firmware Updates

The DXM has been designed to be a robust and secure IOT device. To provide the most reliable and secure device possible, periodic firmware updates are released to enhance and expand the capabilities of the DXM. Firmware updates and description details are found on the Banner website. Customers with critical update requirements will get access to pre-released firmware from the factory.

Website Information

The Banner website is the main method of disseminating DXM information to customers. The data found on the website include:

- DXM instruction manuals
- Configuration manuals
- Firmware downloads
- Firmware release notes
- Errata data, any known issues with a release of firmware
- Possible work-around solutions for known issues
- DXM Solutions Guides

Feature Requests

Our customer is our most valuable resource to improve our DXM. If you have suggestions for improvements to the DXM or configuration tools, please contact Banner Engineering Corp.

Potential DXM Issues

Potential issues with the DXM are collected from Banner's support engineers to provide solutions. Users can get help from the website documentation or by calling Banner Engineering for support help. Solutions are as simple as configuration adjustments, work-around configuration solutions, or potential new firmware updates.

DXM Security

The DXM was designed to collect local wireless sensor data, local sensor data, provide simple control, and send the data to the cloud.

The DXM does not run a Linux or Windows based operating system but an embedded real-time operating system (RTOS) environment. As a proprietary operating system, the security aspects are easier to manage and minimize.

Security updates are released through the Banner Engineering Corp website (www.bannerengineering.com) and New Product Release Announcements (NPRA).

Contact Us

Banner Engineering Corp. headquarters is located at:
9714 Tenth Avenue North
Minneapolis, MN 55441, USA
Phone: + 1 888 373 6767

For worldwide locations and local representatives, visit www.bannerengineering.com.

Warnings

WARNING:



- **Do not use this device for personnel protection**
- Using this device for personnel protection could result in serious injury or death.
- This device does not include the self-checking redundant circuitry necessary to allow its use in personnel safety applications. A device failure or malfunction can cause either an energized (on) or de-energized (off) output condition.

IMPORTANT: Please download the complete DXMR90-4K IO-Link Master technical documentation, available in multiple languages, from www.bannerengineering.com for details on the proper use, applications, Warnings, and installation instructions of this device.

IMPORTANT: Por favor descargue desde www.bannerengineering.com toda la documentación técnica de los DXMR90-4K IO-Link Master, disponibles en múltiples idiomas, para detalles del uso adecuado, aplicaciones, advertencias, y las instrucciones de instalación de estos dispositivos.

IMPORTANT: Veuillez télécharger la documentation technique complète des DXMR90-4K IO-Link Master sur notre site www.bannerengineering.com pour les détails sur leur utilisation correcte, les applications, les notes de sécurité et les instructions de montage.

Install and properly ground a qualified surge suppressor when installing a remote antenna system. Remote antenna configurations installed without surge suppressors invalidate the manufacturer's warranty. Keep the ground wire as short as possible and make all ground connections to a single-point ground system to ensure no ground loops are created. No surge suppressor can absorb all lightning strikes; do not touch the Sure Cross® device or any equipment connected to the Sure Cross device during a thunderstorm.

Exporting Sure Cross® Radios. It is our intent to fully comply with all national and regional regulations regarding radio frequency emissions. **Customers who want to re-export this product to a country other than that to which it was sold must ensure the device is approved in the destination country.** The Sure Cross wireless products were certified for use in these countries using the antenna that ships with the product. When using other antennas, verify you are not exceeding the transmit power levels allowed by local governing agencies. This device has been designed to operate with the antennas listed on Banner Engineering's website and having a maximum gain of 9 dBm. Antennas not included in this list or having a gain greater than 9 dBm are strictly prohibited for use with this device. The required antenna impedance is 50 ohms. To reduce potential radio interference to other users, the antenna type and its gain should be so chosen such that the equivalent isotropically radiated power (EIRP) is not more than that permitted for successful communication. Consult with Banner Engineering Corp. if the destination country is not on this list.

IMPORTANT:

- **Never operate a 1 Watt radio without connecting an antenna**
- Operating 1 Watt radios without an antenna connected will damage the radio circuitry.
- To avoid damaging the radio circuitry, never apply power to a Sure Cross® Performance or Sure Cross MultiHop (1 Watt) radio without an antenna connected.

IMPORTANT:

- **Electrostatic discharge (ESD) sensitive device**
- ESD can damage the device. Damage from inappropriate handling is not covered by warranty.
- Use proper handling procedures to prevent ESD damage. Proper handling procedures include leaving devices in their anti-static packaging until ready for use; wearing anti-static wrist straps; and assembling units on a grounded, static-dissipative surface.

Banner Engineering Corp Limited Warranty

Banner Engineering Corp. warrants its products to be free from defects in material and workmanship for one year following the date of shipment. Banner Engineering Corp. will repair or replace, free of charge, any product of its manufacture which, at the time it is returned to the factory, is found to have been defective during the warranty period. This warranty does not cover damage or liability for misuse, abuse, or the improper application or installation of the Banner product.

THIS LIMITED WARRANTY IS EXCLUSIVE AND IN LIEU OF ALL OTHER WARRANTIES WHETHER EXPRESS OR IMPLIED (INCLUDING, WITHOUT LIMITATION, ANY WARRANTY OF MERCHANTABILITY OR FITNESS FOR A PARTICU-

LAR PURPOSE), AND WHETHER ARISING UNDER COURSE OF PERFORMANCE, COURSE OF DEALING OR TRADE USAGE.

This Warranty is exclusive and limited to repair or, at the discretion of Banner Engineering Corp., replacement. **IN NO EVENT SHALL BANNER ENGINEERING CORP. BE LIABLE TO BUYER OR ANY OTHER PERSON OR ENTITY FOR ANY EXTRA COSTS, EXPENSES, LOSSES, LOSS OF PROFITS, OR ANY INCIDENTAL, CONSEQUENTIAL OR SPECIAL DAMAGES RESULTING FROM ANY PRODUCT DEFECT OR FROM THE USE OR INABILITY TO USE THE PRODUCT, WHETHER ARISING IN CONTRACT OR WARRANTY, STATUTE, TORT, STRICT LIABILITY, NEGLIGENCE, OR OTHERWISE.**

Banner Engineering Corp. reserves the right to change, modify or improve the design of the product without assuming any obligations or liabilities relating to any product previously manufactured by Banner Engineering Corp. Any misuse, abuse, or improper application or installation of this product or use of the product for personal protection applications when the product is identified as not intended for such purposes will void the product warranty. Any modifications to this product without prior express approval by Banner Engineering Corp will void the product warranties. All specifications published in this document are subject to change; Banner reserves the right to modify product specifications or update documentation at any time. Specifications and product information in English supersede that which is provided in any other language. For the most recent version of any documentation, refer to: www.bannerengineering.com.

For patent information, see www.bannerengineering.com/patents.

Document title: DXMR90-4K IO-Link Master Instruction Manual

Part number: 229492

Revision: B

Original Instructions

© Banner Engineering Corp. All rights reserved.



 [LinkedIn](#)

 [Twitter](#)

 [Facebook](#)

