



# Barcode Reading Basics

A barcode is a visual expression of data designed specifically to be read by machines. They store information such as model number, serial number, or product history. Barcodes are used across industries to track products throughout the entire supply chain.



The “traditional” barcode, 1D or linear, is made up of parallel black lines and white spaces of various widths. Product data is stored within the black bars and white spaces. 1D barcodes have a long history in many industries.

### Common 1D Barcodes & Industries that Utilize Them

<b>INTERLEAVED 2 of 5</b>  076354431647 Industrial	<b>EAN-13 / UPC-A</b>  0 12345 67890 5 US Retail
<b>CODE 128</b>  Banner Material Handling	

### Composition of a 1D Barcode

The diagram illustrates the structure of a 1D barcode. It shows a sequence of vertical bars of varying widths. Labels include: 'Start code' at the beginning, 'Bar' for the main data bars, 'Check digit' at the end, and 'Stop code' at the very end. Below the bars, the numbers '012345' are shown as the 'Human Readable Code'. 'Module Width' is indicated as the width of a single bar, and 'Quiet zones' are the blank spaces at the beginning and end of the barcode.

2D barcodes are becoming increasingly popular in factory automation as the need to store more data increases. A 2D barcode contains data stacked both horizontally and vertically, greatly increasing the possible characters stored in the code as well as the density and complexity of information.

### Common 2D Barcodes & Industries that Utilize Them

<b>DataMatrix</b>  Automotive Electronics USPS	<b>QR Code</b>  Automotive Commercial Marketing
--	--

### Composition of a 2D Barcode

The diagram illustrates the structure of a 2D barcode. It shows a square grid of small squares. Labels include: 'Cell' for a single square in the grid, 'Clocking pattern' for the border of the grid, 'Module Width' for the width of a single cell, 'Finder or "L" pattern' for the corner markers, and 'Quiet zone' for the blank area around the barcode.

# Barcode Reading in Factory Automation



## Track and Trace

Barcodes are used to track packaged products through the entire supply chain. They contain important product information that must be verified at multiple points on the line. In the event of a recall, barcodes can be used to quickly identify affected products.

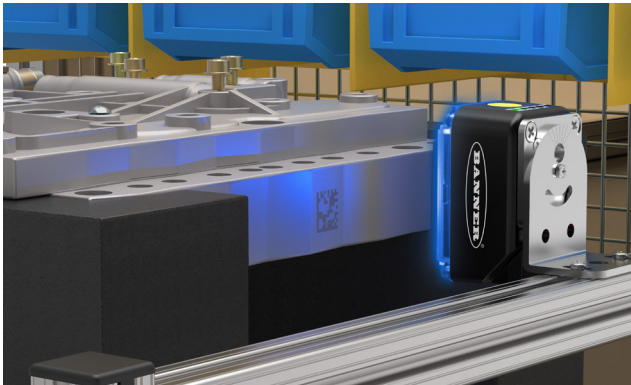

## DPM Code Reading

Direct Part Marks (DPM) are barcodes that are etched or printed directly onto the surface of a part instead of affixed by a label. The benefit of these codes is that they cannot be easily removed, obscured, or damaged so they last as long as the part itself. However, DPM codes can be extremely challenging to read due to poor contrast, so finding a DPM code reading solution is essential for reliable identification.



## Frequent Product Changeover

Product changeover is common on the manufacturing floor and having a flexible barcode reader that can be adjusted quickly is critical to reduce downtime.



## Identification and Inspection

It is a common in factory automation to inspect parts for quality while also tracking them at the same time. Vision inspection tools and identification capabilities can be combined in one device for simplified installation. Not only is the presence and position of components verified, but the barcode can also be used to track the part through the entire production process.

# Choosing a Barcode Reader

Start with the ABR 3000

- Ultra compact housing
- Problem solving features
- Multiple models to choose from



If the following are needed:

- Simplified touchscreen for programming and monitoring
- Variety of integrated LED light options available
- Interchangeable lenses, including C-mount



If the following are needed:

- Autofocus availability
- Faster barcode reading
- Longer range or larger field of view
- Master/slave functionality
- Difficult DPM barcode reading



If the following are needed:

- Identification and Inspection in one device
- Longest range or largest field-of-view
- Higher resolution, up to 5MP
- Faster barcode reading





ABR 3000



ABR 7000



iVu BCR



VE BCR

<b>Lens Options</b>		Factory installed, fully adjustable manual focus	Factory Installed, fully adjustable manual focus or autofocus	Interchangeable microvideo C-mount	C-mount
<b>Maximum Resolution</b>		1.2 MP	2 MP	0.3 MP	5 MP
<b>Maximum Acquisition Speed</b>		57 fps	60 fps	60 fps	60 fps
<b>1D Performance</b> (Code 128 - 20 mil)	<b>Maximum Reading Distance (mm)</b>	443	1185	2258	2747
	<b>Field of View (mm) at Maximum Reading Distance</b>	337 x 259	532 x 401	127 x 81	439 x 347
	<b>Maximum Decode Rate*</b>	25/second	50/second	35/second	52/second
<b>2D Performance</b> (Data Matrix - 20 mil)	<b>Maximum Reading Distance (mm)</b>	285	874	2258	2747
	<b>Field of View (mm) at Maximum Reading Distance</b>	219 x 168	394 x 297	127 x 81	439 x 347
	<b>Maximum Decode Rate*</b>	23/second	37/second	29/second	38/second
<b>Lighting</b>					External Only
<b>Size (L x W x H)</b>		45 x 30 x 24 mm	54 x 42 x 95 mm	81 x 52 x 93 mm	67 x 41 x 88 mm
<b>IP Rating</b>		IP65	IP67	IP67	IP67
<b>Special Features</b>		Polarized	Polarized, Advanced DPM, Master/Slave	Built-in Display	Vision Inspection
<b>Programming</b>					
<b>Image Viewing</b>					
<b>Communication Type</b>		USB 2.0, EtherNet/IP, Modbus/TCP, SLMP, PROFINET compatible, RS-232, RS-422	EtherNet/IP, Modbus/TCP, SLMP, PROFINET compatible, RS-232, RS-422	EtherNet/IP, PROFINET, Modbus/TCP, RS-232	EtherNet/IP, PROFINET Modbus/TCP, RS-232
<b>Ethernet Speed</b>		100 Mbps	100 Mbps	100 Mbps	1000 Mbps

\* Max Decode Rate = At full resolution

KEY

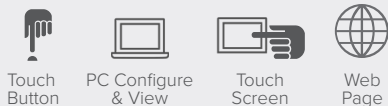



# ABR 3000 Series

## Ultracompact Design, Powerful Capabilities

- Powerful decoding capability to read even difficult 1D and 2D codes
- Ultra-compact metal housing for industrial environments
- Quick configuration with push buttons or software interface
- Available in multiple resolutions and with USB or Ethernet communications
- Integrated LED lighting and easy focus adjustment in one package for maximum application flexibility
- Green "good-read" feedback spotlight and beeper for easy monitoring
- Embedded webserver interface for monitoring images and statistics over any network

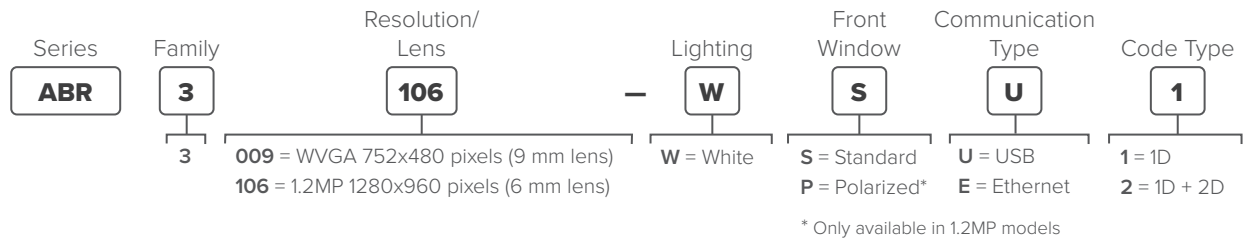

1D and 2D Reading Range by Model

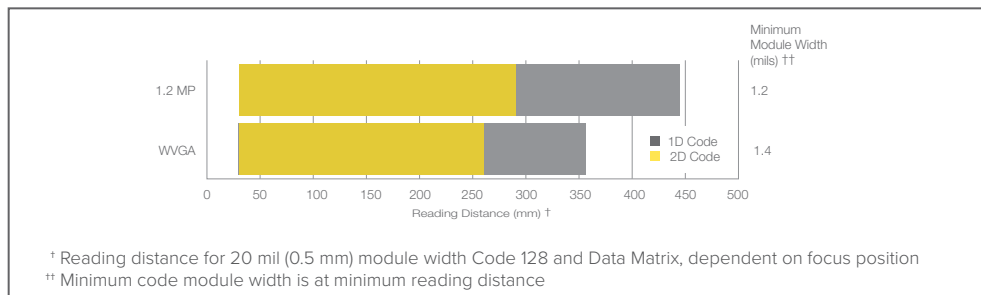

Ethernet models for communicating on the factory floor



USB communication models for tight industrial spaces



Rear view

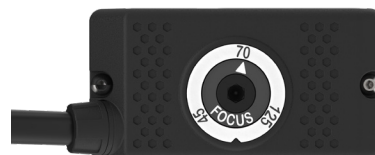

Rear view



## Tracking Products through Packaging

### Challenges

- Inconsistent quality of barcodes printed on glossy, shiny, or reflective packaging material
- Multiple product labels with barcodes printed in different orientations
- Limited space available to deploy barcode reader

### Solution

- Polarized ABR 3000 with robust decoding capability to read damaged, deformed, and overprinted codes on reflective surfaces
- Ability to read multiple 1D or 2D codes in any orientation
- Complete, all-in-one solution in an ultra-compact housing



## Reliable Detection of Small 2D Codes on Vials

### Challenges

- 2D codes store lot codes, formulation and expiration dates
- Presence and accuracy of codes must be verified for product recalls/quality assurance
- Limited space requires a reader with small housing and adjustable focus

### Solution

- Compact housing and adjustable focus of ABR 3000 enables flexible deployment in limited space
- USB communication interfaces with laboratory equipment
- Detects missing or incorrect codes and sends an output alarm



# ABR 7000 Series

## Power and Versatility to Solve Any Application

- Reliably reads the most difficult 1D and 2D barcodes
- Compact, all-in-one solution for industrial environments
- High-resolution imager and fast processing time to solve tough applications
- Autofocus available for faster setup and product line changes
- Superior integrated lighting for long-range use, low-contrast codes, and direct part marking (DPM) applications

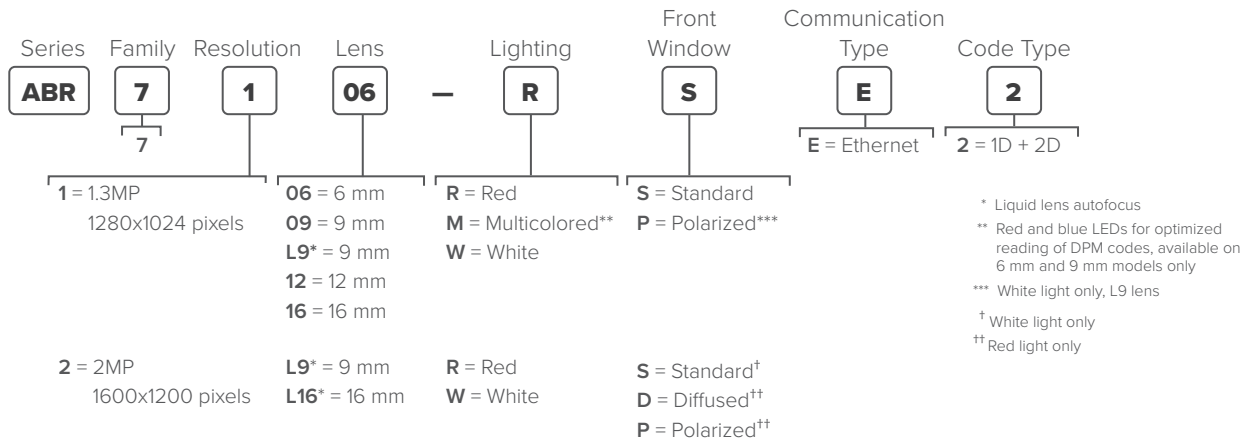

1D and 2D Reading Range by Model

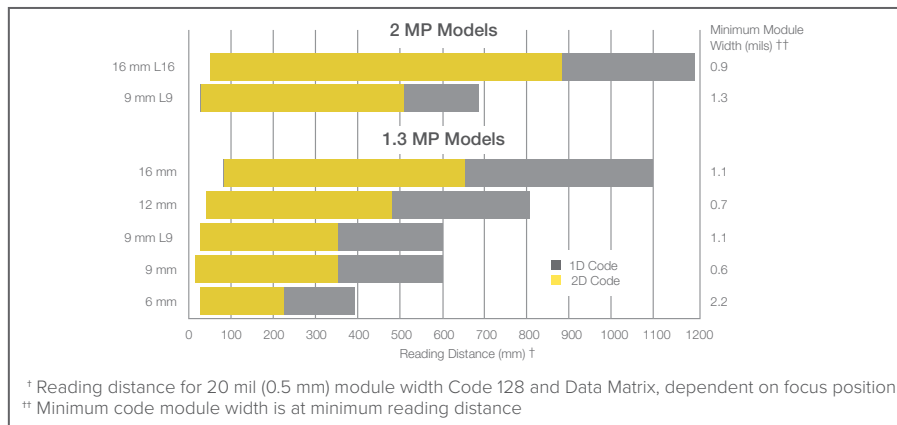

Multiple light colors available



Multicolored LEDs for bright-field and dark-field illumination



Bright, uniform LED lighting



Rotatable QD for tight spaces





## Packages of Varying Height with Multiple 1D and 2D Barcodes

### Challenges

- Multiple 1D and 2D barcodes printed on each label
- Barcode position and orientation varies with the location of each package on the conveyor
- Box height varies with each line changeover

### Solution

- ABR 7000 capable of reading multiple 1D and 2D barcodes in a single inspection
- Wide field-of-view enables inspections over a large area
- Autofocus lens easily adapt to changes in box size when the line changes over



## Small DPM Codes on Electronic Components

### Challenges

- 2D codes are directly marked on electronic components
- Contains dense information on the component, such as serial number
- DPM codes are low-contrast and thus more difficult to read
- Must read the multiple component codes with high accuracy

### Solution

- ABR 7000 features 2 MP for small, challenging DPM codes
- Polarized windows reduce glare from shiny materials
- Customizable bright field and dark field light configurations ensure higher contrast for reliable code reads
- Autofocus allows for product line changeover without manually readjusting on the device



# iVu BCR Series

## Powerful 1D and 2D Barcode Readers

- Touchscreen for the simplest on the fly programming and monitoring
- Reads multiple 1D and 2D barcodes in any orientation with one device
- Multiple integrated light options for maximum contrast
- Interchangeable lenses for ultimate application flexibility
- Rugged IP67 housing for factory environments
- Also available in grayscale and color vision inspection models

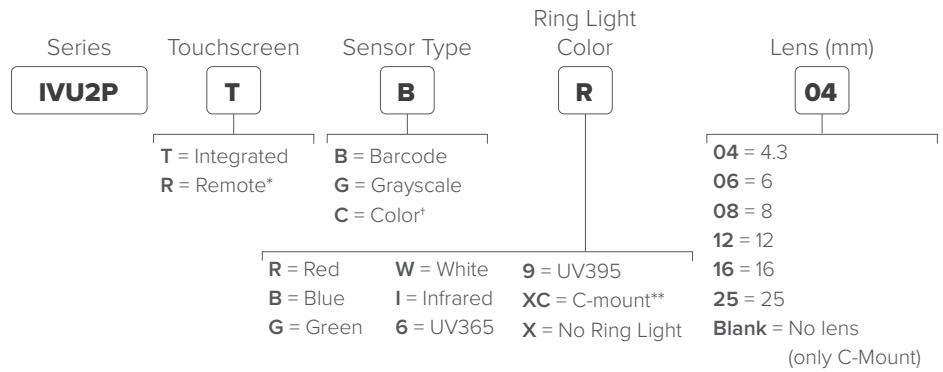

\* Remote touchscreen or PC is required for set up and viewing of Remote Touchscreen sensors  
 \*\* Requires C-mount lens  
 † Color sensor only available in white, C-mount or no ring light

Integrated touchscreen for configuration and monitoring on the factory floor

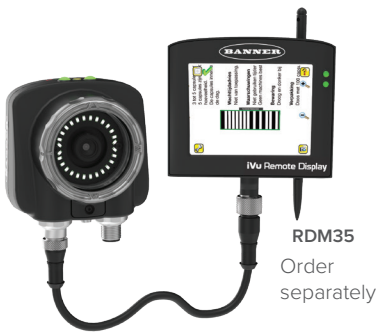

Remote touchscreen model available for configuration and monitoring in hard to reach spaces



PC software for remote configuration and monitoring of multiple barcode readers



## Barcode Reading in Robotic Cell

### Challenge

- Reading barcodes on boxes placed by a robot that vary in position
- Product changeover requires frequent updates to barcode reader settings
- No access to adjust settings on the reader within the work cell due to safety concerns
- Robots in work cells should not be interrupted to maintain the highest possible throughput

### Solution

- iVu BCR with remote display compatibility is mounted within the work cell
- The remote display is mounted 16 m away from the iVu BCR, allowing for changes to settings and programs without entering the work cell
- Runtime editing allows for limited downtime: changes can be made immediately without requiring the inspection to be stopped



## Barcode Reading for Invisible Ink

### Challenges

- Barcodes printed with clear ink must be read to verify product information and ensure quality
- Clear ink is low in contrast and thus difficult to detect
- Lights must be added to the solution to create contrast for accurate reading

### Solution

- iVu BCR is coupled with a UV ring light to create contrast for an all-in-one solution
- Touch screen interface and menu-driven software tools make it easy to configure and troubleshoot
- IP67-rated for use in environments that require cleaning



# VE Series

## Compact, Durable, and Versatile Smart Camera

- Easy-to-use Vision Manager Software provides a number of tools and capabilities that enable VE Series Smart Cameras to solve a wide range of vision and identification applications
- Available in multiple resolutions all with the same powerful inspection and/or identification capabilities
- Runtime editing allows for real-time changes to be made to reduce costly downtime
- Factory communications (EtherNet/IP, Modbus/TCP, PROFINET, and Serial RS-232) for integration on the manufacturing floor
- Robust IP67 housing with built in display for updating sensor settings or facilitating product changeover

Select a camera resolution

Choose lens based on application needs



Optional filters create additional contrast

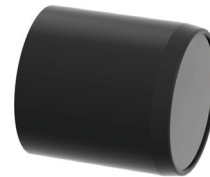

IP67 lens covers or ring lights available for additional protection

Family

**VE**

Resolution

**202**

200 = WVGA, 752 x 480 pixels  
 201 = 1.3 MP, 1280 x 1024 pixels  
 202 = 2 MP, 1600 x 1200 pixels  
 205 = 5 MP, 2592 x 2048 pixels

Imager

**G1**

G1 = Grayscale

Device Type\*

**A**

A = Vision  
 B = ID  
 C = Vision + ID

\* Vision models offer full suite of vision inspection capabilities, Identification (ID) models offer barcode reading capability. Vision + ID models offer full inspection and identification capabilities. See product specifications for full tool listing.

### Solutions for:



#### Identification

- Track and Trace as parts transition through the supply chain
- Package verification for tracking, sorting



#### Presence/Absence

- Count vials in a tray
- Verify correct labeling



#### Orientation/Position

- Verify the orientation of an IC chip
- Send part location to a pick-and-place robot



#### Flaw Detection

- Calculate the eccentricity of pizza crust
- Identify burn marks on a nonwoven web



#### Measuring

- Measure critical dimensions of a stamped part
- Measure bottle cap height

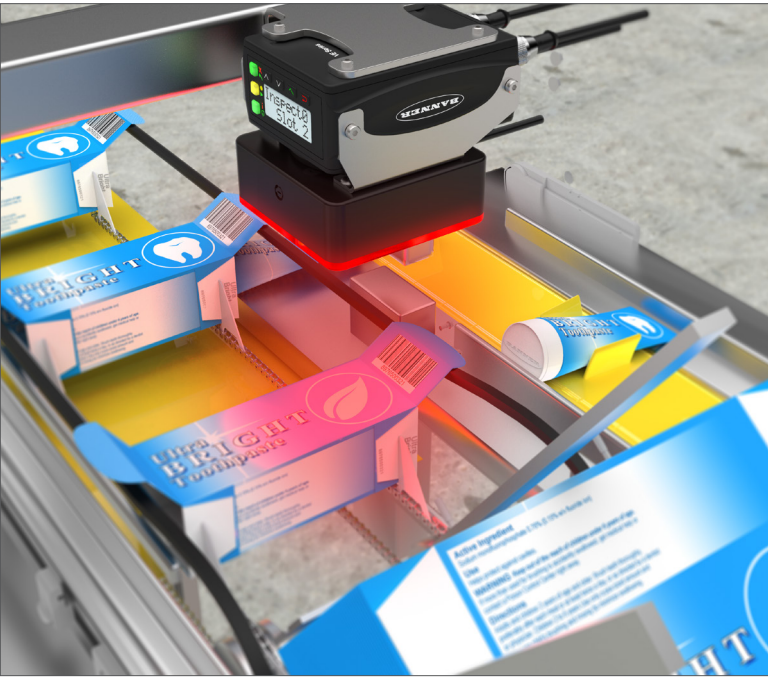

## Barcode Reading and Package Verification

### Challenge

- Tubes of toothpaste must be placed in cartons
- A logo on the tube indicates the type of toothpaste in the box
- Frequent product changeover, printing mistakes, and other factors can result in mispackaging

### Solution

- VE Smart Camera reads the barcode to check that it matches the correct data for the tube being filled
- Match Tool inspects and verifies the product logo
- Product changeover can be performed automatically over Ethernet, or manually with the configuration software or built-in display



Match  
Tool



Barcode  
Tool

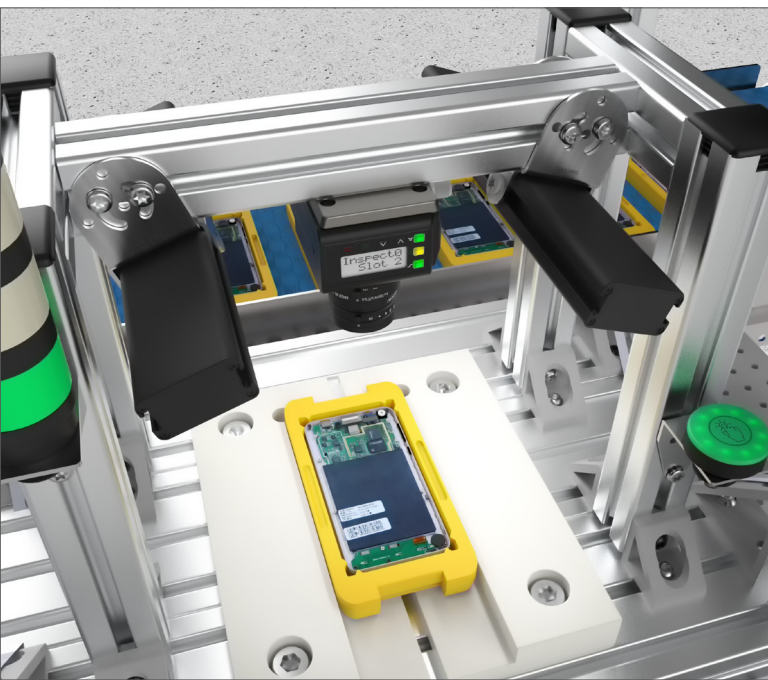

## Assembly Inspection and Tracking

### Challenge

- Cell phones are comprised of many small electric parts
- Components must be verified for presence and correct installation
- Components can also be stamped with barcodes that contain additional information
- Products must be verified for traceability throughout the production process

### Solution

- 5 MP VE Smart Camera allows for higher-resolution inspection and identification
- Vision tools in the camera detect the presence and position of components
- Barcode reading capabilities ensure the assembly is tracked through production



Barcode  
Tool

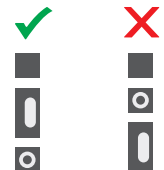

Match  
Tool

# Accessories

## Cordsets for Use with ABR Models

### For Use with ABR Ethernet Models

Power (Required)  
17-pin M12 female shielded (for power, serial and IO)



**MQDC2S-1706**  
2 m (6.5 ft)  
**MQDC2S-1715**  
5 m (15 ft)  
**MQDC2S-1730**  
9 m (30 ft)

4-pin M12 D-code to RJ45 Ethernet Communication Cordsets (Required for ethernet communication and PC programming)

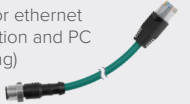

**STP-M12D-406**  
2 m (6.5 ft)  
**STP-M12D-415**  
5 m (15 ft)  
**STP-M12D-430**  
9 m (30 ft)

### For Use with ABR USB Models

Power and USB Communication only

17-pin M12 female to USB



**MQDEC-1703SS-USB**

OR

Power, USB Communication, IO and Serial Communication

17-pin M12 female shielded (for power, serial and IO)



**MQDC2S-1706**  
2 m (6.5 ft)  
**MQDC2S-1715**  
5 m (15 ft)  
**MQDC2S-1730**  
9 m (30 ft)

Splitter cable. 17-pin M12 female trunk with one 17-pin M12 male branch and one USB branch

**CSB-M121701USB02M121702**



## Cordsets for Use with iVu Models

Power (Required)

12-pin M12/Euro-Style with Shield  
Straight connector models listed; for right-angle models, add RA to the model number (example, MQDC2S-1215RA)



**MQDC2S-1206**  
2 m (6.5')  
**MQDC2S-1215**  
5 m (15')  
**MQDC2S-1230**  
9 m (30')

Communication Cordsets (Required for Ethernet communication and PC programming)



**IVUC-E-406**  
2 m (6.5')  
**IVUC-E-415**  
5 m (15')  
**IVUC-E-430**  
9 m (30')  
**IVUC-E-450**  
12 m (50')  
**IVUC-E-475**  
23 m (75')

RJ45 to 4-Pin Pico QD

USB

Used to update firmware and access sensor files



**PSG-4M-4005-USB**  
0.15 m (0.5')  
**PSG-4M-401-USB**  
0.3 m (1')  
**PSG-4M-403-USB**  
0.9 m (3')

4-pin pico straight connector models listed

## Cordsets for Use with VE Models

Power (Required)

12-pin M12/Euro-Style with Shield  
Straight connector models listed; for right-angle models, add RA to the model number (example, MQDC2S-1215RA)



**MQDC2S-1206**  
2 m (6.5')  
**MQDC2S-1215**  
5 m (15')  
**MQDC2S-1230**  
9 m (30')

Communication Cordsets (Required for Programming)



**STP-M12-806**  
1.83 m (6 ft)  
**STP-M12-815**  
4.57 m (15 ft)  
**STP-M12-830**  
9.14 m (30 ft)

RJ45 Ethernet to 8-Pin Threaded M12/Euro-Style (Cat5e Shielded)

Adapter Cordset (optional)

8-pin male M12 to 4-pin M12 D-code female (optional Ethernet communication cable)



**STP-8M12-4M12D**  
0.5 m (1.6 ft)

## Use with ABR Models

### Memory Module TCNM-ACMK-100

Provides backup and restore capability when used with connection box

### Connection Box TCNM-ACBB1

Provide simplified wiring and connection for ABR readers



### For Use with TCNM-ACBB1 Connection Box

17-pin M12 female to DB25 (replaces MQDC2S-17xx)

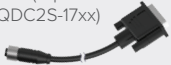

**MQDEC-1703SS-DB25**  
0.9 m (3 ft)

17-pin female to 17-pin male shielded (optional extension cable)



**MQDEC-1706SS**  
2 m (6.5 ft)  
**MQDEC-1715SS**  
5 m (15 ft)  
**MQDEC-1730SS**  
9 m (30 ft)

## Use with iVu Models

### Remote Display



**RDM35**  
Remote programming and monitoring display



**SMBRDM35**  
Docking station for machine mountable remote display

Machine Mountable Remote Display (Required for use of RDM35 remote display)



Double-ended 8-pin M12/Euro-Style. Straight connector models listed; for right-angle, add RA to the model number (example, IVURDM-QD-803RA)

**IVURDM-QD-803**  
1 m (3')  
**IVURDM-QD-806**  
2 m (6')  
**IVURDM-QD-815**  
5 m (15')

## Use with VE Models

### Sealed Ring Lights

IP67 lights that are powered and controlled by camera (work with most lenses)



### Borosilicate Glass Window

Blue	<b>LEDBRV75BM</b>
Green	<b>LEDGRV75BM</b>
Infrared	<b>LEDIRV75BM</b>
Red	<b>LEDRRV75BM</b>
White	<b>LEDWRV75BM</b>

### Polycarbonate Window

Blue	<b>LEDBRV75PM</b>
Green	<b>LEDGRV75PM</b>
Infrared	<b>LEDIRV75PM</b>
Red	<b>LEDRRV75PM</b>
White	<b>LEDWRV75PM</b>

## Use with iVu Models

### Microvideo Lenses

Used for standard models. Additional interchangeable lenses available for application flexibility



Description	Model
4.3 mm	LMF04
6 mm	LMF06
8 mm	LMF08
12 mm	LMF12
16 mm	LMF16
25 mm	LMF25

### Filter Kits†

Optional accessory used to create additional contrast

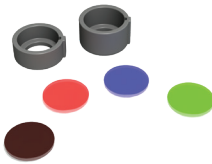

Description	Model
Red	FLTMR2
Blue	FLTMB
Green	FLTMG
Infrared	FLTMI*

\* Infrared pass filters are preinstalled on infrared ring light models.

† Filter kits include 1 color and two sizes of filter holders.

### C-mount Lenses (required for C-mount models)



Focal Length	Model	Focal Length	Model
6 mm	LCF06LEVMP	25 mm	LCF25LEVMP
8 mm	LCF08LEVMP	35 mm	LCF35LEVMP
12 mm	LCF12LEVMP	50 mm	LCF50LEVMP
16 mm	LCF16LEVMP	75 mm	LCF75LEVMP

### C-Mount Lens Covers

Provides IP67 rating for C-Mount sensor



Description	Model
50 mm	IVUSLC50-P
75 mm	IVUSLC75-P

### Brackets



**SMBIVURAL**  
Stainless steel left  
mount right-angle  
bracket



**SMBIVURAR**  
Stainless steel right  
mount right-angle  
bracket



**SMBIVUU**  
Stainless steel  
U-shaped swivel  
bracket

## Use with VE Models

### Megapixel C-mount Lenses

for use with WVGA, 1.3 MP, or 2 MP cameras



Focal Length	Model	Focal Length	Model
6 mm	LCF06LEVMP	25 mm	LCF25LEVMP
8 mm	LCF08LEVMP	35 mm	LCF35LEVMP
12 mm	LCF12LEVMP	50 mm	LCF50LEVMP
16 mm	LCF16LEVMP	75 mm	LCF75LEVMP

### 1" Format C-Mount Lenses

for use with 5 MP cameras



Focal Length	Model	Focal Length	Model
6 mm	LCF06LK1F	25 mm	LCF25LK1F
8 mm	LCF08LK1F	35 mm	LCF35LK1F
12 mm	LCF12LK1F	50 mm	LCF50LK1F
16 mm	LCF16LK1F	75 mm	LCF75LK1F

### Sealed Lens Covers

Painted aluminum covers for IP67 rating (work with most lenses)

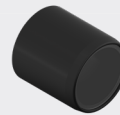

	Borosilicate Glass Window	Polycarbonate Window
60 mm	VELC60-BG	VELC60-PC
85 mm	VELC85-BG	VELC85-PC

### Bandpass Filters

for use with Megapixel C-mount Lenses\*

Type	Model	Type	Model
Blue	FLTB470-27	Red	FLTR635-27
Green	FLTG525-27	Dark Red	FLTR660-27
Infrared	FLTI850-27	Linear Polarizer	FLTPR032-27

\* For use with 8 to 35 mm focal lengths. Contact the factory for additional options.

### Brackets



**SMBVERA**  
Right-angle bracket



**SMBVEMP**  
Mounting plate with  
M8x1.25, 10-32, and  
1/2-20 adapter holes



## Who is Banner?

Every 3.5 seconds, a Banner sensor is installed somewhere in the world. Banner solves problems for most of the manufacturing companies in the Fortune 500, as well as the startups changing industry with leading-edge production.

Banner technology supports manufacturing of the cars you drive, the food you eat, the medicine you take and virtually every product in your daily life. Whatever the industry, Banner offers solutions to automate production, improve efficiency and manufacture to the highest standard of quality.

## Manufacturing Specialists

With over 30,000 products, Banner is a leading source for manufacturing needs. We offer award-winning sensors, wireless solutions, vision sensors and lighting, machine safety, indicator lights and LED lighting.

## Application Solution Experts

Our field sales engineers are the most highly-trained and experienced professionals in the industry. They can rapidly analyze an application to help you find the best solution.

## Global Presence

Banner offers worldwide sales and support through a network of more than 3,000 professionals ready to help you no matter where you are located.

## Unique Solutions

Banner's growing product line includes thousands of standard products. However, if you have an application requiring a unique solution or direct integration of a Banner product, contact one of Banner's Application Engineers to learn about our rapid customization and ability to deliver special product variations.

Talk with an app engineer.  
Get product specs.  
Order now.

