

## Features

Sure Cross® Wireless Q45 Sensors combine the best of Banner's flexible Q45 sensor family with its reliable, field-proven, Sure Cross wireless architecture to solve new classes of applications limited only by the user's imagination. Containing a variety of sensor models, a radio, and an internal battery supply, this product line is truly plug-and-play.

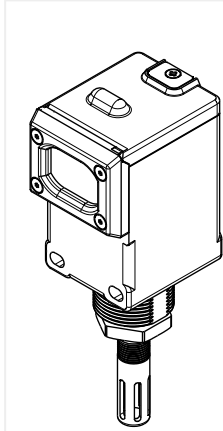

The Wireless Q45THA All-in-One Temperature and Humidity Sensor Node combines a temperature and humidity probe with the reliable, field-proven, Sure Cross wireless architecture into one package, eliminating the need for ordering multiple components and reducing the physical size of the device. The industrial grade, battery-powered device can be used to wirelessly transmit temperature and humidity values to a wireless controller or Gateway for remote monitoring of critical systems.

### Benefits:

- Measures temperature and relative humidity
- Houses the sensor element in a robust case
- Adapter available for compressed air line temperature and humidity monitoring
- No additional sensor wiring
- Ideal for monitoring:
  - Refrigerators or chillers
  - Warehouses
  - Cleanrooms
  - Incubators
  - Storage rooms
  - Distribution Centers

## Quick Start Guide

Continue reading the datasheet for more detailed instructions.

1. Set the DIP switches.
2. Install the battery.  
The radio powers on automatically.
3. Bind the Q45 to its Gateway (DXM Controller or DX80 Performance Gateway) and assign a node ID to the Q45.
4. Mount the Q45.
5. Collect the data with the DXM Controller or Gateway from Input 1 through 3 (relative humidity, temperature °C, and temperature °F, respectively).
6. Scale the data.  
The measured temperature = (Register Data + 20). The relative humidity data does not require scaling.
7. Use the scaled data in the DXM Controller/Gateway to monitor the application, set triggers or alarms, and send data to PLC/HMI/Cloud platform for historical collection and visualization.

## Q45THA Models

Model	Radio Frequency	Inputs
DX80N9Q45THA	900 MHz ISM Band	Temperature and relative humidity (%)
DX80N2Q45THA	2.4 GHz ISM Band	

To order an integrated battery model without the battery, add **NB** to the model number. For example, **DX80N9Q45THA NB**.

## Overview

For the first five minutes after power is applied, the Node operates in fast sample mode, sampling and sending data every two seconds. After five minutes, the Node defaults to five-minute sample intervals. To activate fast sample mode, single-click the binding button. The amber LED is ON solid during the fast sample mode. To exit fast sample mode, click the binding button five times.

## Storage Mode

While in **storage mode**, the device's radio does not operate, to conserve the battery. To put any device into storage mode, press and hold the binding button for five seconds. The device is in storage mode when the LEDs stop blinking. To wake the device, press and hold the binding button (inside the housing on the radio board) for five seconds.



## Configuration Instructions

### Button and LEDs

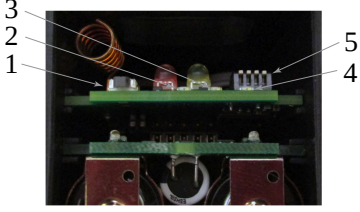
	1	Binding button
	2	Red LED (flashing) indicates a radio link error with the Gateway.
	3	Green LED (flashing) indicates a good radio link with the Gateway.
	4	Amber LED is not used.
	5	DIP switches

### DIP Switches

After making any changes to any DIP switch position, reboot the Q45 by triple-clicking the binding button, waiting a second, then double-clicking the binding button.

The DIP switches are in the OFF position, by default. To turn a DIP switch on, push the switch toward the battery pack. DIP switches one through four are numbered from left to right. The factory default sample and report rate is 5 minutes.

	DIP Switches							
	1	2	3	4	5	6	7	8
900 MHz transmit power level: 1 Watt (30 dBm)	OFF *							
900 MHz transmit power level: 250 mW (24 dBm), DX80 compatibility mode	ON							
Reserved		OFF *						
Reserved			OFF *					
Reserved				OFF *				
Reserved					OFF *			
Modbus or software configured (overrides DIP switches)						OFF *	OFF *	OFF *
Sample/report rate of 15 minutes						OFF	OFF	ON
Sample/report rate of 5 minutes						OFF	ON	OFF
Sample/report rate of 64 seconds						OFF	ON	ON
Reserved						ON	OFF	OFF
Reserved						ON	OFF	ON
Reserved						ON	ON	OFF
Reserved						ON	ON	ON

Refer to the [Configuring for Sample on Demand](#) technical note for details on sampling on demand and using a host system.

### Transmit Power Levels

The 900 MHz radios transmit at 1 Watt (30 dBm) or 250 mW (24 dBm). The 250 mW mode reduces the radio's range but improves the battery life in short-range applications. For 2.4 GHz models, this DIP switch is disabled. The transmit power for 2.4 GHz is fixed at about 65 mW EIRP (18 dBm).

### Sample and Report Rates

The sample interval, or rate, defines how often the Sure Cross device samples the input. For battery-powered applications, setting a slower rate extends the battery life.

The report rate defines how often the Node communicates the I/O status to the Gateway. For battery-powered applications, setting the report rate to a slower rate extends the battery life.

### Apply Power to the Q45

Follow these instructions to install or replace the lithium "AA" cell batteries.

As with all batteries, these are fire, explosion, and severe burn hazards. Do not burn or expose them to high temperatures. Do not recharge, crush, disassemble, or expose the contents to water. Properly dispose of used batteries according to local regulations by taking it to a hazardous waste collection site, an e-waste disposal center, or another facility qualified to accept lithium batteries.

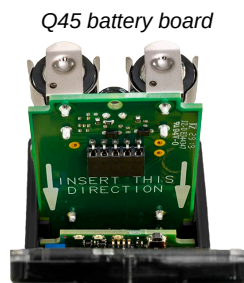

1. Loosen the clamp plate with a small Phillips screwdriver and lift the cover.
2. Slide the battery board out of the Q45 housing.
3. If applicable, remove the discharged batteries.
4. Install the new batteries.  
Use Banner's **BWA-BATT-006** replacement batteries or equivalent 3.6 V AA lithium batteries, such as Xeno's XL-60F.
5. Verify the battery's positive and negative terminals align to the positive and negative terminals of the battery holder mounted within the case.  
CAUTION: There is a risk of explosion if the battery is replaced incorrectly.
6. Slide the board containing the new batteries back into the Q45 housing.
7. Close the cover and gently tighten the clamp plate with the small Phillips screwdriver.

## Bind to the Gateway and Assign the Node Address

Before beginning the binding procedure, apply power to all the devices. Separate the devices by two meters when running the binding procedure. Put only one Gateway into binding at a time to prevent binding to the wrong Gateway.

1. On the Gateway: Enter binding mode.
  - For housed DX80 Gateways, triple-click button 2 on the Gateway. Both LEDs flash red.
  - For Gateway board modules, triple-click the button. The green and red LED flashes.
2. Assign the Q45 a Node address using the Gateway's rotary dials. Use the left rotary dial for the left digit and the right rotary dial for the right digit. For example, to assign your Q45 to Node 10, set the Gateway's left dial to 1 and the right dial to 0. Valid Node addresses are 01 through 47.
3. On the Q45: Loosen the clamp plate on the top of the Q45 and lift the cover.
4. Enter binding mode on the Q45 by triple-clicking the Q45's button.  
The red and green LEDs flash alternately and the sensor searches for a Gateway in binding mode. After the Q45 is bound, the LEDs stay solid momentarily, then they flash together four times. The Q45 exits binding mode.
5. Label the sensor with the Q45's Node address number for future reference.
6. Repeat steps 2 through 5 for as many Q45s as are needed for your network.
7. On the Gateway: After binding all Q45s, exit binding mode.
  - For housed DX80 Gateways, double-click button 2.
  - For board-level DX80 Gateways, double-click the button.

For Gateways with single-line LCDs: After binding your Q45 to the Gateway, make note of the binding code displayed under the Gateway's \*DVCFG menu, XADR submenu on the LCD. Knowing the binding code prevents having to re-bind all Q45s if your Gateway is ever replaced.

## Bind to a DXM and Assign the Node Address

Before beginning the binding procedure, apply power to all the devices. Separate the radios by two meters when running the binding procedure. Put only one DXM into binding mode at a time to prevent the Q45 from binding to the wrong Gateway.

1. On the DXM: Use the arrow keys to select the **ISM Radio** menu on the LCD and click **ENTER**.
2. Highlight the **Binding** menu and click **ENTER**.
3. Use the arrow keys to select the Node address to bind the Q45 to.
4. On the Q45: Loosen the top clamp plate and lift the cover.
5. Enter binding mode by triple-clicking the binding button.

The red and green LEDs flash alternately and the sensor searches for a Gateway in binding mode. After the Node binds, the LEDs stay solid momentarily, then they flash together four times. The Node exits binding mode.

6. Label the sensor with the Node address number for future reference.
7. On the DXM: Click **BACK** to exit binding for that specific Node address.
8. Repeat steps 3 through 7 and change the Node address for as many Q45s as are needed for your network.
9. On the DXM: After you have finished forming your network, click **BACK** until you reach the main menu.

## Modbus Holding Registers

I/O #	Modbus Holding Register		I/O Type	I/O Range		Holding Register Representation	
	Gateway	Any Node		Min.	Max.	Min.	Max.
1	1	1 + (Node# × 16)	Relative Humidity (%RH)	0	100.00	0	10000
2	2	2 + (Node# × 16)	Temperature °C	-1638.3	1638.4	-32768	32767
3	3	3 + (Node# × 16)	Temperature °F	-1638.3	1638.4	-32768	32767
		...					
7	7	7 + (Node# × 16)	Reserved				
8	8	8 + (Node# × 16)	Device Message				
		...					
15	15	15 + (Node# × 16)	Control Message				
16	16	16 + (Node# × 16)	Reserved				

The measured temperature = (Modbus register value) ÷ 20.

## Installing the BWA-FTH-001 Adapter

Use the **BWA-FTH-001** NPT adapter to monitor temperature and humidity across compressed air lines with the Q45THA All-in-One Temperature and Humidity Sensor Node. Do not use the adapter and probe assembly to monitor liquid temperature.

**IMPORTANT:** Do not contaminate the black threads or any portion of the sensing devices to avoid damaging the probes and giving erroneous measurements. An airtight seal is required between the M12×1 connection of the Q45THA and the NPT adapter to ensure a proper temperature and humidity measurement.

*Installing the BWA-FTH-001 adapter*

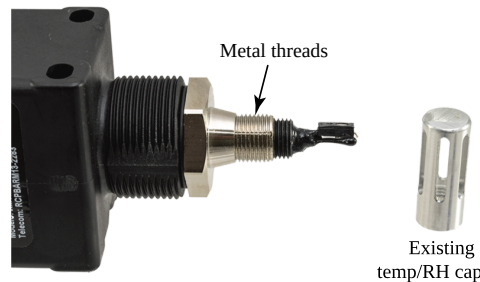

1. Remove the existing temperature-humidity cap at the base of the Q45THA Sensor Node.
2. Apply thread sealant to the metal threaded portion of the temperature and humidity sensor. Banner recommends using a non-hardening, high-pressure-rated pipe thread sealant such as Rectorseal T PLUS 2 or an equivalent.
3. Carefully thread the BWA-FTH-001 adapter onto the Q45THA Sensor Node.

*The BWA-FTH-001 adapter installed*

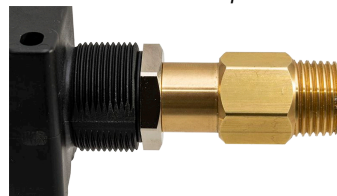

## Specifications

### Specifications for the Performance Radio with Internal Antenna

#### Radio Range

900 MHz, 1 Watt: Up to 3.2 km (2 miles) with line of sight (internal antenna)

2.4 GHz, 65 mW: Up to 1000 m (3280 ft) with line of sight (internal antenna)

Range depends on the environment and decreases significantly without line of sight. Always verify your wireless network's range by performing a Site Survey.

#### Radio Transmit Power

900 MHz, 1 Watt: 30 dBm (1 W) conducted (up to 36 dBm EIRP)

2.4 GHz, 65 mW: 18 dBm (65 mW) conducted, less than or equal to 20 dBm (100 mW) EIRP

#### Antenna Minimum Separation Distance

900 MHz, 150 mW and 250 mW: 2 m (6 ft)

900 MHz, 1 Watt: 4.57 m (15 ft)

2.4 GHz, 65 mW: 0.3 m (1 ft)

#### Spread Spectrum Technology

FHSS (Frequency Hopping Spread Spectrum)

#### Link Timeout (Performance)

Gateway: Configurable via User Configuration Software

Node: Defined by Gateway

#### 900 MHz Compliance (SX7023 Radio Module)

Radio module is indicated by the product label marking

Contains FCC ID: UE3SX7023EXT: FCC Part 15, Subpart C, 15.247

Contains IC: 7044A-SX7023EXT

#### 900 MHz Compliance (RM1809 Radio Module)

Radio module is indicated by the product label marking  
Contains FCC ID: UE3RM1809: FCC Part 15, Subpart C, 15.247

Contains IC: 7044A-RM1809

IFT: RCPBARM13-2283



#### 2.4 GHz Compliance (DX80-2400 Radio Module)

Radio module is indicated by the product label marking

Contains FCC ID: UE300DX80-2400: FCC Part 15, Subpart C, 15.247

Radio Equipment Directive (RED) 2014/53/EU

Contains IC: 7044A-DX8024

ANATEL: 15966-21-04042



#### 2.4 GHz Compliance (SX243 Radio Module)

Radio module is indicated by the product label marking

Contains FCC ID: UE3SX243: FCC Part 15, Subpart C, 15.247

Radio Equipment Directive (RED) 2014/53/EU

ETSI/EN: EN 300 328 V2.2.2 (2019-07) [RED HarmStds]

Contains IC: 7044A-SX243

ANATEL: 03737-22-04042



### Specifications for the Wireless Q45THA Sensor Node

#### Temperature

Measuring Range:  $-40\text{ }^{\circ}\text{C}$  to  $+85\text{ }^{\circ}\text{C}$  ( $-40\text{ }^{\circ}\text{F}$  to  $+185\text{ }^{\circ}\text{F}$ )

Operating the devices at the maximum operating conditions for extended periods can shorten the life of the device.

Resolution:  $0.1\text{ }^{\circ}\text{C}$

#### Accuracy

$-40\text{ }^{\circ}\text{C}$  to  $0\text{ }^{\circ}\text{C}$ :  $\pm 0.6\text{ }^{\circ}\text{C}$

$0\text{ }^{\circ}\text{C}$  to  $60\text{ }^{\circ}\text{C}$ :  $\pm 0.4\text{ }^{\circ}\text{C}$

$+60\text{ }^{\circ}\text{C}$  to  $+85\text{ }^{\circ}\text{C}$ :  $\pm 1.2\text{ }^{\circ}\text{C}$

#### Humidity

Measuring Range: 0 to 100% relative humidity (RH)

Resolution: 0.1% relative humidity

#### Accuracy:

$\pm 2\%$  at  $25\text{ }^{\circ}\text{C}$

$\pm 3\%$  at  $0\text{ }^{\circ}\text{C}$  to  $70\text{ }^{\circ}\text{C}$  and 10–90% RH

$\pm 7\%$  at  $0\text{ }^{\circ}\text{C}$  to  $70\text{ }^{\circ}\text{C}$  and 0–10% or 90–100% RH

#### Default Sensing Interval

5 minutes

#### Typical Battery Life

See chart

#### Indicators

Red and green LEDs (radio function)

#### Construction

Molded reinforced thermoplastic polyester housing, orange-sealed transparent Lexan® cover, molded acrylic lenses, and stainless steel hardware. Designed to withstand 1200 psi washdown.

#### Certifications



Banner Engineering BV  
Park Lane, Culliganlaan 2F bus 3  
1831 Diegem, BELGIUM



Turck Banner LTD Blenheim House  
Blenheim Court  
Wickford, Essex SS11 8YT  
GREAT BRITAIN

(CE/UKCA approval only applies to 2.4 GHz models)

### Q45 Environmental Specifications

#### Operating Conditions

-40 °C to +70 °C (-40 °F to +158 °F); 90% at +50 °C maximum relative humidity (non-condensing)  
 Radiated Immunity: 10 V/m (EN 61000-4-3)

**Environmental Rating**  
 NEMA 6P  
 IP67

Operating the devices at the maximum operating conditions for extended periods can shorten the life of the device.

## Q45THA Dimensions

All measurements are listed in millimeters, unless noted otherwise.

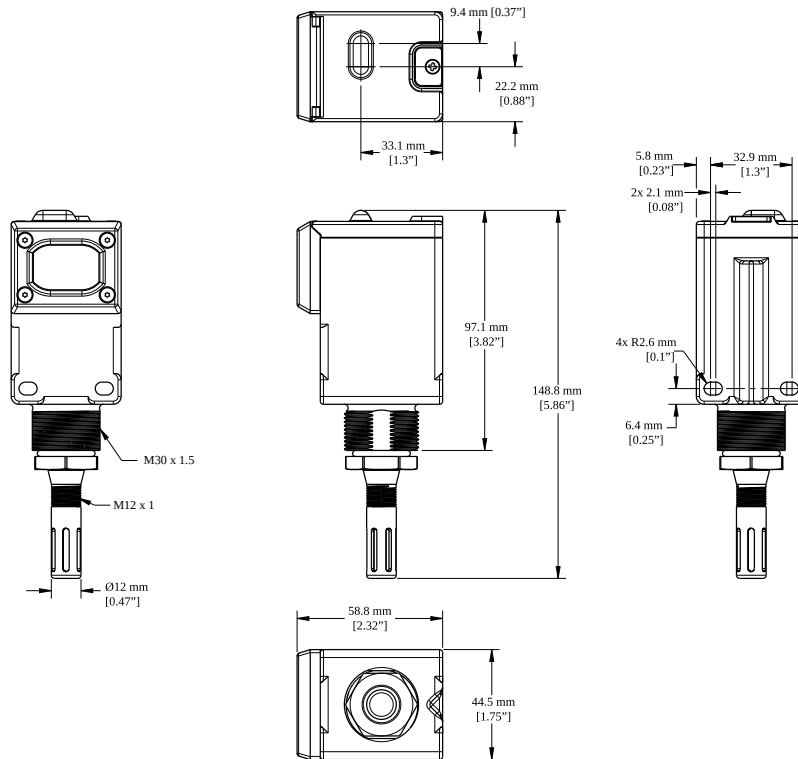

## Battery Life for the Q45THA

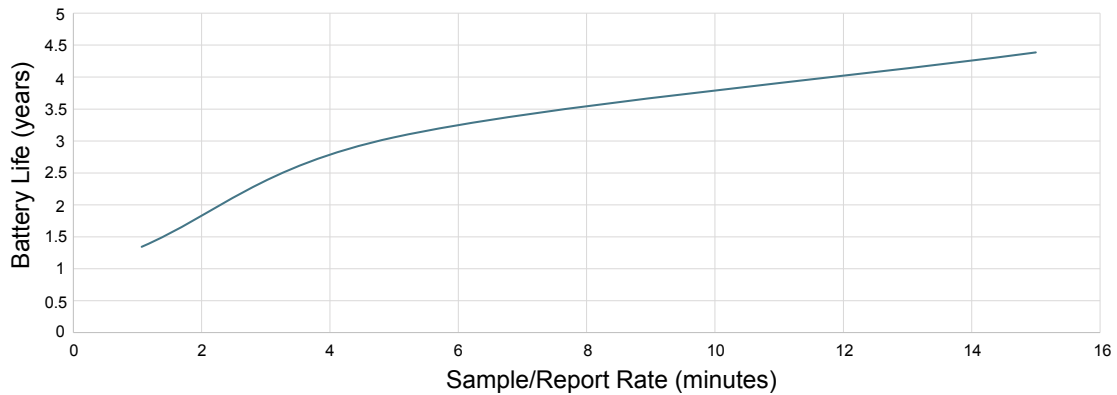

## Q45THA and TA Accessories

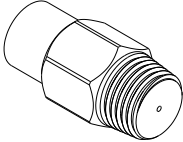
<p><b>BWA-BATT-006</b></p> <ul style="list-style-type: none"> <li>• 3.6 V Lithium AA cell</li> <li>• Two batteries</li> </ul>	
<p><b>BWA-FTH-001</b></p> <ul style="list-style-type: none"> <li>• M12 × 1 mm female to 1/2-inch NPT male adapter</li> <li>• Brass</li> </ul>	

## Temperature-Humidity Filter Caps

<p><b>FTH-FIL-001</b></p> <ul style="list-style-type: none"> <li>• Aluminum grill filter cap</li> <li>• Factory default, ships with the M12FT*Q and Q45 All-in-One sensors</li> </ul>		<p><b>FTH-FIL-002</b></p> <ul style="list-style-type: none"> <li>• Stainless steel</li> <li>• Sintered to 40-micrometer porosity (for high dust environments.)</li> </ul>	
---	---	---	---

## Warnings

**Exporting Sure Cross® Radios.** It is our intent to fully comply with all national and regional regulations regarding radio frequency emissions. **Customers who want to re-export this product to a country other than that to which it was sold must ensure the device is approved in the destination country.** The Sure Cross wireless products were certified for use in these countries using the antenna that ships with the product. When using other antennas, verify you are not exceeding the transmit power levels allowed by local governing agencies. This device has been designed to operate with the antennas listed on Banner Engineering's website and having a maximum gain of 9 dBm. Antennas not included in this list or having a gain greater than 9 dBm are strictly prohibited for use with this device. The required antenna impedance is 50 ohms. To reduce potential radio interference to other users, the antenna type and its gain should be so chosen such that the equivalent isotropically radiated power (EIRP) is not more than that permitted for successful communication. Consult with Banner Engineering Corp. if the destination country is not on this list.

**IMPORTANT:** Please download the complete Wireless Q45THA All-in-One Temperature and Humidity Sensor Node technical documentation, available in multiple languages, from [www.bannerengineering.com](http://www.bannerengineering.com) for details on the proper use, applications, Warnings, and installation instructions of this device.

**IMPORTANT:** Por favor descargue desde [www.bannerengineering.com](http://www.bannerengineering.com) toda la documentación técnica de los Wireless Q45THA All-in-One Temperature and Humidity Sensor Node, disponibles en múltiples idiomas, para detalles del uso adecuado, aplicaciones, advertencias, y las instrucciones de instalación de estos dispositivos.

**IMPORTANT:** Veuillez télécharger la documentation technique complète des Wireless Q45THA All-in-One Temperature and Humidity Sensor Node sur notre site [www.bannerengineering.com](http://www.bannerengineering.com) pour les détails sur leur utilisation correcte, les applications, les notes de sécurité et les instructions de montage.

### WARNING:



- **Do not use this device for personnel protection**
- Using this device for personnel protection could result in serious injury or death.
- This device does not include the self-checking redundant circuitry necessary to allow its use in personnel safety applications. A device failure or malfunction can cause either an energized (on) or de-energized (off) output condition.

### IMPORTANT:

- **Electrostatic discharge (ESD) sensitive device**
- ESD can damage the device. Damage from inappropriate handling is not covered by warranty.
- Use proper handling procedures to prevent ESD damage. Proper handling procedures include leaving devices in their anti-static packaging until ready for use; wearing anti-static wrist straps; and assembling units on a grounded, static-dissipative surface.

## Banner Engineering Corp Limited Warranty

Banner Engineering Corp. warrants its products to be free from defects in material and workmanship for one year following the date of shipment. Banner Engineering Corp. will repair or replace, free of charge, any product of its manufacture which, at the time it is returned to the factory, is found to have been defective during the warranty period. This warranty does not cover damage or liability for misuse, abuse, or the improper application or installation of the Banner product.

**THIS LIMITED WARRANTY IS EXCLUSIVE AND IN LIEU OF ALL OTHER WARRANTIES WHETHER EXPRESS OR IMPLIED (INCLUDING, WITHOUT LIMITATION, ANY WARRANTY OF MERCHANTABILITY OR FITNESS FOR A PARTICULAR PURPOSE), AND WHETHER ARISING UNDER COURSE OF PERFORMANCE, COURSE OF DEALING OR TRADE USAGE.**

This Warranty is exclusive and limited to repair or, at the discretion of Banner Engineering Corp., replacement. **IN NO EVENT SHALL BANNER ENGINEERING CORP. BE LIABLE TO BUYER OR ANY OTHER PERSON OR ENTITY FOR ANY EXTRA COSTS, EXPENSES, LOSSES, LOSS OF PROFITS, OR ANY INCIDENTAL, CONSEQUENTIAL OR SPECIAL DAMAGES RESULTING FROM ANY PRODUCT DEFECT OR FROM THE USE OR INABILITY TO USE THE PRODUCT, WHETHER ARISING IN CONTRACT OR WARRANTY, STATUTE, TORT, STRICT LIABILITY, NEGLIGENCE, OR OTHERWISE.**

Banner Engineering Corp. reserves the right to change, modify or improve the design of the product without assuming any obligations or liabilities relating to any product previously manufactured by Banner Engineering Corp. Any misuse, abuse, or improper application or installation of this product or use of the product for personal protection applications when the product is identified as not intended for such purposes will void the product warranty. Any modifications to this product without prior express approval by Banner Engineering Corp will void the product warranties. All specifications published in this document are subject to change; Banner reserves the right to modify product specifications or update documentation at any time. Specifications and product information in English supersede that which is provided in any other language. For the most recent version of any documentation, refer to: [www.bannerengineering.com](http://www.bannerengineering.com).

For patent information, see [www.bannerengineering.com/patents](http://www.bannerengineering.com/patents).

## Notas Adicionales

Información México: La operación de este equipo está sujeta a las siguientes dos condiciones: 1) es posible que este equipo o dispositivo no cause interferencia perjudicial y 2) este equipo debe aceptar cualquier interferencia, incluyendo la que pueda causar su operación no deseada.

Banner es una marca registrada de Banner Engineering Corp. y podrán ser utilizadas de manera indistinta para referirse al fabricante. "Este equipo ha sido diseñado para operar con las antenas tipo Omnidireccional para una ganancia máxima de antena de 6 dBd y Yagi para una ganancia máxima de antena 10 dBd que en seguida se enlistan. También se incluyen aquellas con aprobación ATEX tipo Omnidireccional siempre que no excedan una ganancia máxima de antena de 6dBd. El uso con este equipo de antenas no incluidas en esta lista o que tengan una ganancia mayor que 6 dBd en tipo omnidireccional y 10 dBd en tipo Yagi, quedan prohibidas. La impedancia requerida de la antena es de 50 ohms."

### Approved Antennas

- BWA-902-C**--Antena, Omni 902-928 MHz, 2 dBd, junta de caucho, RP-SMA Macho
- BWA-905-C**--Antena, Omni 902-928 MHz, 5 dBd, junta de caucho, RP-SMA Macho
- BWA-906-A**--Antena, Omni 902-928 MHz, 6 dBd, fibra de vidrio, 1800mm, N Hembra
- BWA-9Y10-A**--Antena, Yagi, 900 MHz, 10 dBd, N Hembra

## Mexican Importer

Banner Engineering de México, S. de R.L. de C.V. | David Alfaro Siqueiros 103 Piso 2 Valle oriente | San Pedro Garza Garcia Nuevo León, C. P. 66269

81 8363.2714