

T18 Series Sensors (DC Voltage)



Datasheet



- Featuring EZ-BEAM® technology for reliable sensing without the need for adjustments (most models)
- “T” style plastic housing with 18 mm threaded lens mount
- Models available in opposed, retroreflective, diffuse, and fixed-field modes
- Completely epoxy-encapsulated to provide superior durability, even in harsh sensing environments rated to IP69K
- Innovative dual-indicator system for simple sensor performance monitoring
- Advanced diagnostics to warn of marginal sensing conditions or output overload
- 10 to 30 V dc; choose SPDT (complementary) NPN or PNP outputs (150 mA maximum, each)



WARNING: Not To Be Used for Personnel Protection

Never use this device as a sensing device for personnel protection. Doing so could lead to serious injury or death. This device does not include the self-checking redundant circuitry necessary to allow its use in personnel safety applications. A sensor failure or malfunction can cause either an energized or de-energized sensor output condition.

Models

Models ¹	Sensing Mode	Range	LED	Output
T186E	Opposed	20 m (66 ft)	Infrared, 950 nm	-
T18SN6R				NPN
T18SP6R				PNP
T18SN6L	Retroreflective with Gain Control	2 m (79 in) ²		NPN
T18SP6L	PNP			
T18SN6LP	Polarized Retroreflective	500 mm (20 in)		Visible Red, 680 nm
T18SP6LP			PNP	
T18SN6D	Diffuse with Gain Control	500 mm (20 in)	Infrared, 880 nm	NPN
T18SP6D				PNP
T18SN6FF25	Fixed Field	25 mm (1 in) Cutoff		NPN
T18SP6FF25				PNP
T18SN6FF50		50 mm (2 in) Cutoff		NPN
T18SP6FF50				PNP
T18SN6FF100		100 mm (4 in) Cutoff		NPN
T18SP6FF100				PNP

¹ Standard 2 m (6.5 ft) cable models are listed.

- To order the 9 m (30 ft) cable models, add suffix W/30 (for example, T186E W/30).
- To order the 4-pin M12/Euro-style QD models, add suffix Q (for example, T186EQ). A model with a QD connector requires a mating cable.

² Use polarized models when shiny objects will be sensed.



Fixed-Field Mode Overview

T18 Sensors self-contained fixed-field sensors are small, powerful, infrared diffuse mode sensors with far-limit cutoff (a type of background suppression). Their high excess gain and fixed-field technology allow them to detect objects of low reflectivity, while ignoring background surfaces.

The cutoff distance is fixed. Backgrounds and background objects must always be placed beyond the cutoff distance.

The T18FF compares the reflections of its emitted light beam (E) from an object back to the sensor's two differently aimed detectors, R1 and R2. If the near detector (R1) light signal is stronger than the far detector (R2) light signal (see object A, closer than the cutoff distance), the sensor responds to the object. If the far detector (R2) light signal is stronger than the near detector (R1) light signal (see object B, beyond the cutoff distance), the sensor ignores the object.

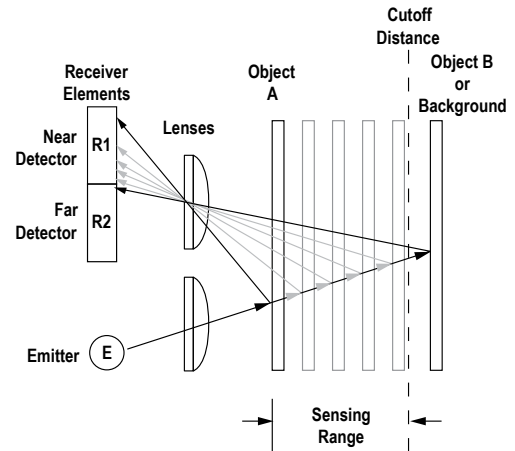

Object is sensed if amount of light at R1 is greater than the amount of light at R2

Figure 1. Fixed-field concept

The cutoff distance for model T18FF sensors is fixed at 25, 50 or 100 millimeters (1 in, 2 in, or 4 in). Objects lying beyond the cutoff distance usually are ignored, even if they are highly reflective. However, it is possible to falsely detect a background object, under certain conditions (see Background Reflectivity and Placement).

In the drawings and discussion on these pages, the letters E, R1, and R2 identify how the sensor's three optical elements (Emitter "E", Near Detector "R1", and Far Detector "R2") line up across the face of the sensor. The location of these elements defines the sensing axis (see Figure 2 on page 2). The sensing axis becomes important in certain situations, such as those illustrated in Figure 5 on page 3 and Figure 6 on page 3.

Sensor Setup

Sensing Reliability

As a general rule, the most reliable sensing of an object approaching from the side occurs when the line of approach is parallel to the sensing axis.

For highest sensitivity, position the target object for sensing at or near the point of maximum excess gain. The excess gain curves for these products are shown. Maximum excess gain for the 25 mm models occurs at a lens-to-object distance of about 7 mm; for 50 mm models, at about 10 mm; and for the 100 mm models, at about 20 mm. Sensing at or near this distance will make maximum use of each sensor's available sensing power. The background must be placed beyond the cutoff distance. (Note that the reflectivity of the background surface also may affect the cutoff distance.) Following these two guidelines will improve sensing reliability.

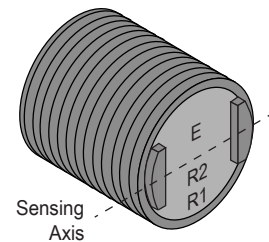

Figure 2. Fixed-field sensing axis

Background Reflectivity and Placement

Avoid mirror-like backgrounds that produce specular reflections. False sensor response will occur if a background surface reflects the sensor's light more strongly to the near detector, or "sensing" detector (R1), than to the far detector, or "cutoff" detector (R2). The result is a false ON condition (see Figure 3 on page 3). To cure this problem, use a diffusely reflective (matte) background, or angle either the sensor or the background (in any plane) so the background does not reflect light back to the sensor (see Figure 4 on page 3). Position the background as far beyond the cutoff distance as possible.

An object beyond the cutoff distance, either stationary (and when positioned as shown in [Figure 5](#) on page 3), or moving past the face of the sensor in a direction perpendicular to the sensing axis, can cause unwanted triggering of the sensor if more light is reflected to the near detector than to the far detector. The problem is easily remedied by rotating the sensor 90° ([Figure 6](#) on page 3). The object then reflects the R1 and R2 fields equally, resulting in no false triggering. A better solution, if possible, may be to reposition the object or the sensor.

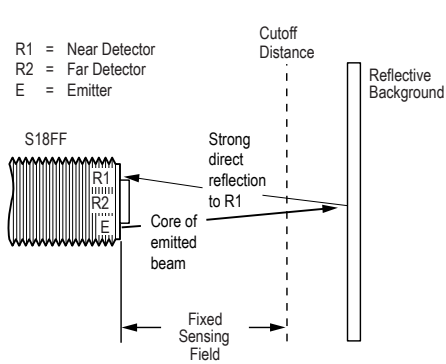

Figure 3. Reflective Background - Problem

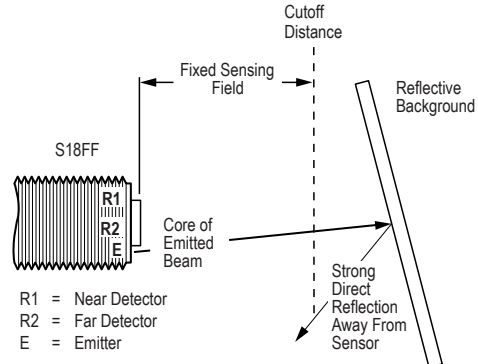

Figure 4. Reflective Background - Solution

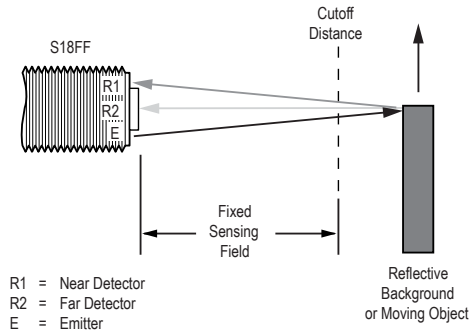

Figure 5. Object Beyond Cutoff - Problem

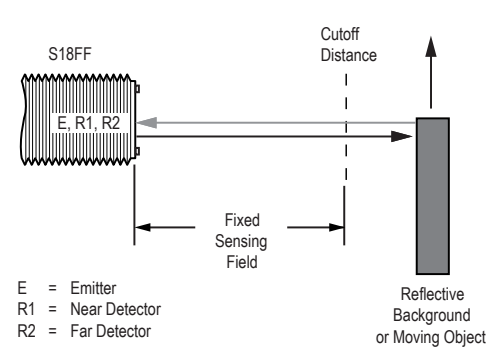

Figure 6. Object Beyond Cutoff - Solution

A reflective background object in this position or moving across the sensor face in this axis and direction may cause false sensor response.

A reflective background object in this position or moving across the sensor face in this axis will be ignored.

Color Sensitivity

The effects of object reflectivity on cutoff distance, though small, may be important for some applications. It is expected that at any given cutoff setting, the actual cutoff distance for lower reflectance targets will be slightly shorter than for higher reflectance targets (see *Performance Curves*). This behavior is known as color sensitivity.

For example, an excess gain of 1 for an object that reflects 1/10 as much light as the 90% white card is represented by the horizontal graph line at excess gain = 10. An object of this reflectivity results in a far limit cutoff of approximately 20 mm (0.8 inches), for the 25 mm (1 inch) cutoff model for example; thus 20 mm represents the cutoff for this sensor and target.

These excess gain curves were generated using a white test card of 90% reflectance. Objects with reflectivity of less than 90% reflect less light back to the sensor, and thus require proportionately more excess gain in order to be sensed with the same reliability as more reflective objects. When sensing an object of very low reflectivity, it may be especially important to sense it at or near the distance of maximum excess gain.

Specifications

Supply Voltage and Current

10 to 30 V dc (10% maximum ripple)

Supply current (exclusive of load current):

Emitters, non-polarized retroreflective, retroreflective, diffuse models: 25 mA

Receivers: 20 mA

Polarized retroreflective models: 30 mA

Fixed-field models: 35 mA

Supply Protection Circuitry

Protected against reverse polarity and transient voltages

Output Configuration

SPDT solid-state dc switch; Choose NPN (current sinking) or PNP (current sourcing) models

Light Operate: N.O. output conducts when sensor sees its own (or the emitter's) modulated light

Dark Operate: N.C. output conducts when the sensor sees dark; the N.C. (normally closed) output may be wired as a normally open marginal signal alarm output, depending upon wiring to power supply (U.S. patent 5087838)

Output Rating

150 mA maximum (each) in standard wiring. When wired for alarm output, the total load may not exceed 150 mA.

OFF-state leakage current: < 1 microamp at 30 V dc

ON-state saturation voltage: < 1 V at 10 mA dc; < 1.5 V at 150 mA dc

Output Protection Circuitry

Protected against false pulse on power-up and continuous overload or short circuit of outputs

Environmental Rating

Leakproof design rated NEMA 6P and IEC IP67 per IEC 60529

IP69K per DIN40050 for quick disconnect and cable models when the cables are protected from direct spray

Operating Conditions

-40 °C to +70 °C (-40 °F to +158 °F)

90% at +50 °C maximum relative humidity (non-condensing)

Vibration and Mechanical Shock

All models meet Mil. Std. 202F requirements. Method 201A (Vibration; frequency 10 Hz to 60 Hz, max., double amplitude 0.06 inch acceleration 10G). Method 213B conditions H&I.

Shock: 75G with unit operating; 100G for non-operation

Certifications



All models, except T186E are UL approved.

Output Response Time

Opposed mode models: 3 ms ON, 1.5 ms OFF

Retroreflective, fixed-field, and diffuse mode models: 3 ms ON and OFF
NOTE: 100 ms delay on power-up; outputs do not conduct during this time.

Repeatability

Opposed mode models: 375 µs

Retroreflective, fixed-field, and diffuse mode models: 750 µs

Repeatability and response are independent of signal strength.

Adjustments

Non-polarized retroreflective and diffuse models (only) have a single-turn rear-panel sensitivity control (turn clockwise to increase gain)

Indicators

Two LEDs (green and amber):

Green on: power to sensor is on

Green flashing: output is overloaded

Amber on: N.O. output is conducting

Amber flashing: excess gain marginal (1 to 1.5x) in light condition

Construction

Housing: PBT polyester housing

Lens: polycarbonate (opposed-mode) or acrylic (other models)

Connections

2 m (6.5 ft) integral cable; 9 m (30 ft) integral cable; or 4-pin M12/ Euro-style quick-disconnect fitting

Required Overcurrent Protection



WARNING: Electrical connections must be made by qualified personnel in accordance with local and national electrical codes and regulations.

Overcurrent protection is required to be provided by end product application per the supplied table.

Overcurrent protection may be provided with external fusing or via Current Limiting, Class 2 Power Supply.

Supply wiring leads < 24 AWG shall not be spliced.

For additional product support, go to <http://www.bannerengineering.com>.

Supply Wiring (AWG)	Required Overcurrent Protection (Amps)
20	5.0
22	3.0
24	2.0
26	1.0
28	0.8
30	0.5

Dimensions

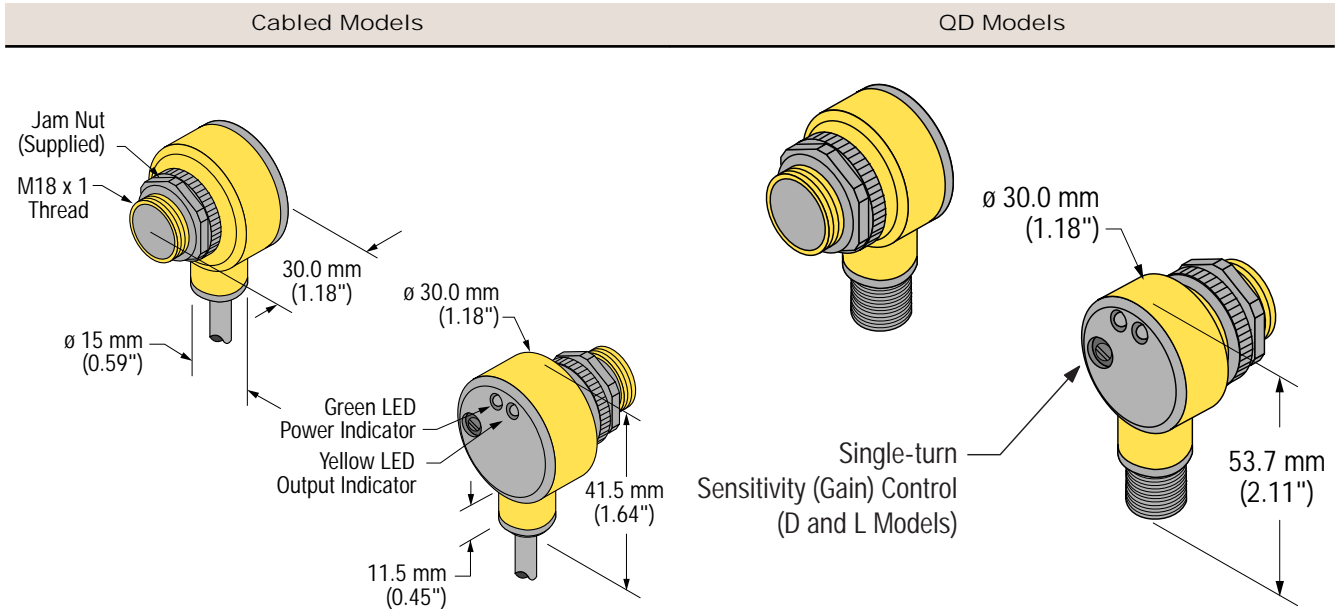

Performance Curves

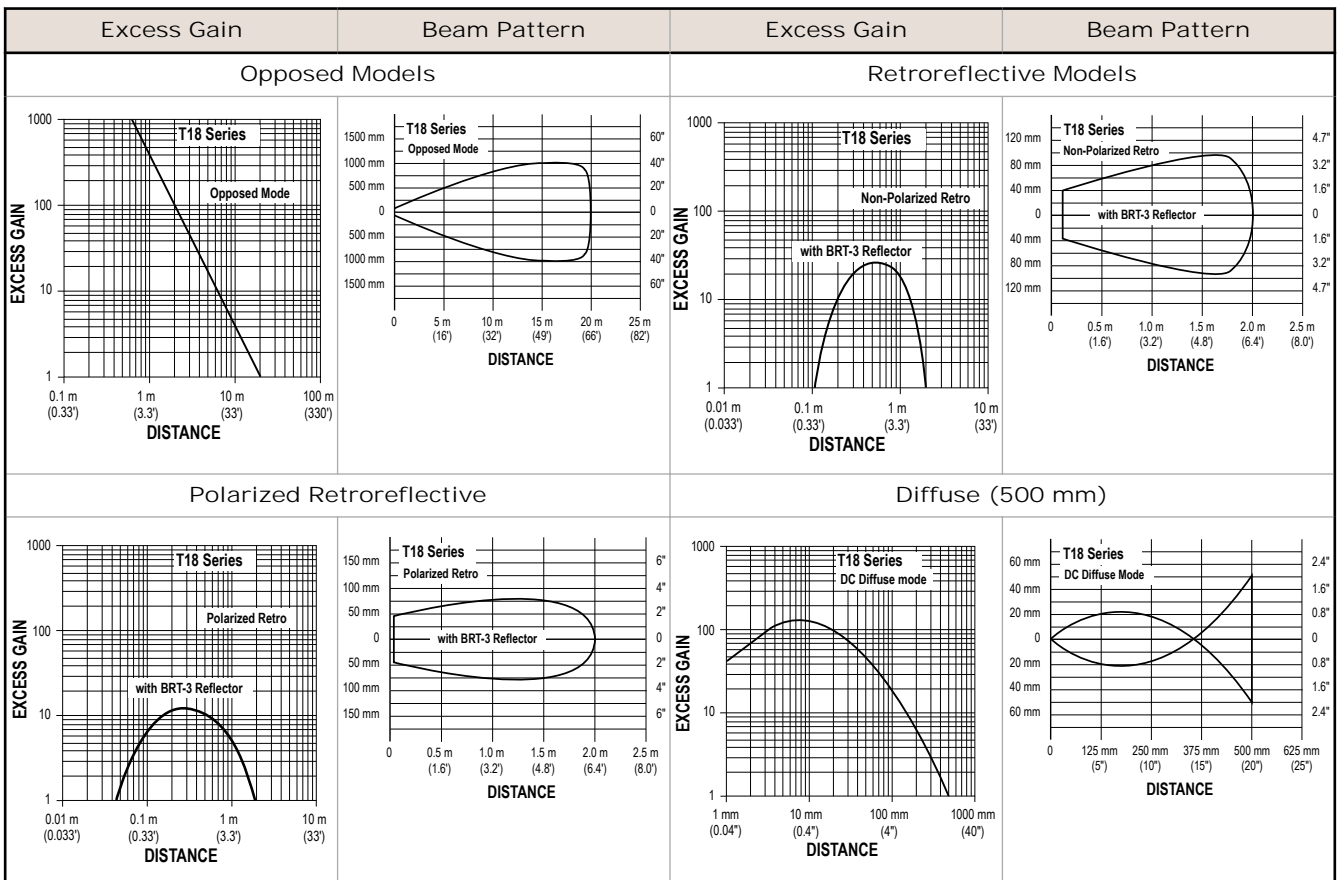

For the polarized retroreflective and retroreflective models, the performance is based on a model BRT-3 retroreflector (3 in diameter). The actual sensing range may be more or less than specified, depending on the efficiency and reflective area of the retroreflector used.

For the diffuse models, the performance is based on a 90% reflectance white test card.

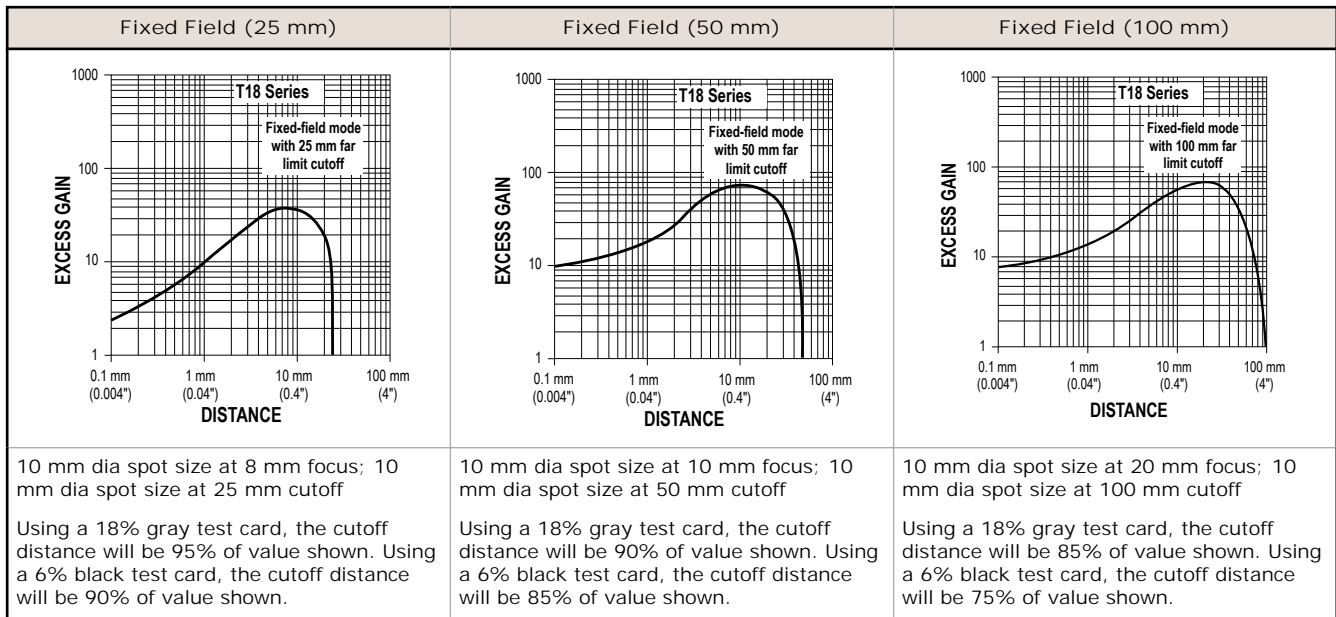

For the fixed field models, the performance is based on a 90% reflectance white test card. Focus and spot sizes are typical.

Wiring Diagrams

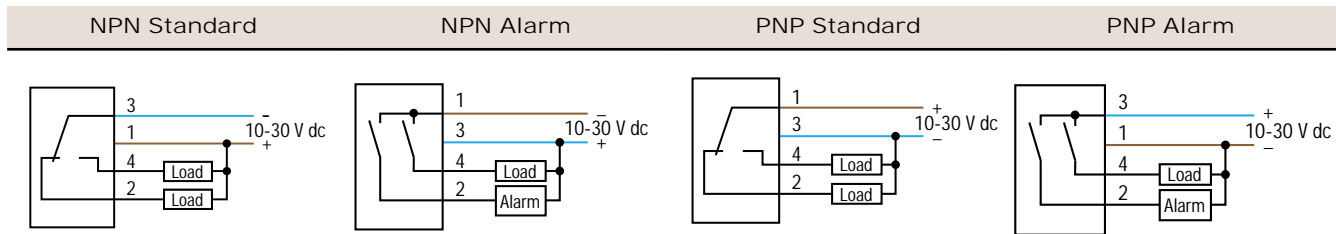
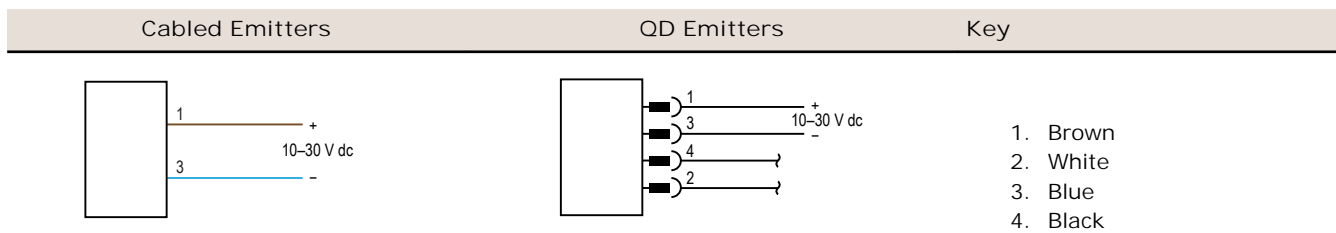

Wiring for the quick disconnect (QD) models is functionally identical.

Accessories

4-Pin Threaded M12/Euro-Style Cordsets				
Model	Length	Style	Dimensions	Pinout (Female)
MQDC-406	1.83 m (6 ft)	Straight		
MQDC-415	4.57 m (15 ft)			
MQDC-430	9.14 m (30 ft)			
MQDC-450	15.2 m (50 ft)			

- 1 = Brown
- 2 = White
- 3 = Blue
- 4 = Black

4-Pin Threaded M12/Euro-Style Cordsets				
Model	Length	Style	Dimensions	Pinout (Female)
MQDC-406RA	1.83 m (6 ft)	Right-Angle		
MQDC-415RA	4.57 m (15 ft)			
MQDC-430RA	9.14 m (30 ft)			
MQDC-450RA	15.2 m (50 ft)			

Banner Engineering Corp. Limited Warranty

Banner Engineering Corp. warrants its products to be free from defects in material and workmanship for one year following the date of shipment. Banner Engineering Corp. will repair or replace, free of charge, any product of its manufacture which, at the time it is returned to the factory, is found to have been defective during the warranty period. This warranty does not cover damage or liability for misuse, abuse, or the improper application or installation of the Banner product.

THIS LIMITED WARRANTY IS EXCLUSIVE AND IN LIEU OF ALL OTHER WARRANTIES WHETHER EXPRESS OR IMPLIED (INCLUDING, WITHOUT LIMITATION, ANY WARRANTY OF MERCHANTABILITY OR FITNESS FOR A PARTICULAR PURPOSE), AND WHETHER ARISING UNDER COURSE OF PERFORMANCE, COURSE OF DEALING OR TRADE USAGE.

This Warranty is exclusive and limited to repair or, at the discretion of Banner Engineering Corp., replacement. IN NO EVENT SHALL BANNER ENGINEERING CORP. BE LIABLE TO BUYER OR ANY OTHER PERSON OR ENTITY FOR ANY EXTRA COSTS, EXPENSES, LOSSES, LOSS OF PROFITS, OR ANY INCIDENTAL, CONSEQUENTIAL OR SPECIAL DAMAGES RESULTING FROM ANY PRODUCT DEFECT OR FROM THE USE OR INABILITY TO USE THE PRODUCT, WHETHER ARISING IN CONTRACT OR WARRANTY, STATUTE, TORT, STRICT LIABILITY, NEGLIGENCE, OR OTHERWISE.

Banner Engineering Corp. reserves the right to change, modify or improve the design of the product without assuming any obligations or liabilities relating to any product previously manufactured by Banner Engineering Corp. Any misuse, abuse, or improper application or installation of this product or use of the product for personal protection applications when the product is identified as not intended for such purposes will void the product warranty. Any modifications to this product without prior express approval by Banner Engineering Corp will void the product warranties. All specifications published in this document are subject to change; Banner reserves the right to modify product specifications or update documentation at any time. For the most recent version of any documentation, refer to: www.bannerengineering.com.