

Instruction Manual

Expert Wide-Beam Retroreflective Sensor



- Wide beam retroreflective sensor for reliable leading edge detection of irregular shaped objects or pallets
- Visible red beam for simple alignment and bright LEDs for visual indication
- Up to 4 meter range for mounting flexibility
- Two sensitivity levels for detection of challenging targets such as shrink wrapped pallets, small objects and film or perforated packaging
- Easy set-up, adjustment and LO/DO selectable via single push button
- 250 Hz switching frequency for high speed production lines
- IP67 and IP69 with ECOLAB® certification for washdown applications



WARNING:

- **Do not use this device for personnel protection**
- Using this device for personnel protection could result in serious injury or death.
- This device does not include the self-checking redundant circuitry necessary to allow its use in personnel safety applications. A device failure or malfunction can cause either an energized (on) or de-energized (off) output condition.

Models

Model	Range	Input	Output	Connection
Q76E-VP-ZLVC-Q5	0.4 m to 4.0 m (1.3 ft to 13.1 ft) ¹	10 V dc to 30 V DC	Complementary PNP	200 mm (7.5 in) PUR cable with a 4-pin M12/Euro-style male quick disconnect
Q76E-VP-ZLVC-Q8				Integral 4-pin M12/Euro-style male quick disconnect
Q76E-VP-ZLVC-2M				2 m (6.5 ft) unterminated 4-wire PVC cable
Q76E-VN-ZLVC-Q5			Complementary NPN	200 mm (7.5 in) PUR cable with a 4-pin M12/Euro-style male quick disconnect
Q76E-VN-ZLVC-Q8				Integral 4-pin M12/Euro-style male quick disconnect
Q76E-VN-ZLVC-2M				2 m (6.5 ft) unterminated 4-wire PVC cable
Q76E-KP-ZLVC-Q5			1 PNP/NPN Light Operate with IO-Link; 1 PNP Dark Operate	200 mm (7.5 in) PUR cable with a 4-pin M12/Euro-style male quick disconnect

¹ Range with a BRT-92X92CB reflector.



Features and Indicators

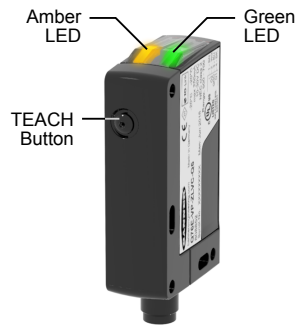

Figure 1. Q76 Features

LED Status		Sensor Status
Green LED	Amber LED	
Green on	Off	Ready
Green on	Amber on	Light path clear (Light Operate mode only)
Green flashing	Amber flashing	TEACH in process

Installation

Sensor Orientation

Optimize sensor performance with correct sensor-to-target orientation.

The small gap in the sensing beam allows precise alignment of the sensor with the object to be detected or with the reflector. Install the sensor so that the object to be detected moves horizontally to the sensor.

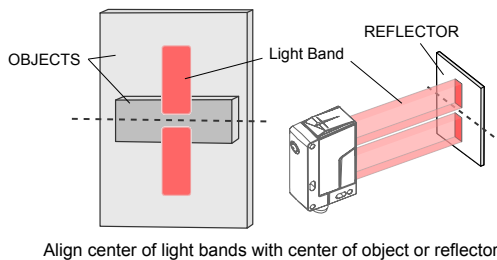

Figure 2. Beam Alignment

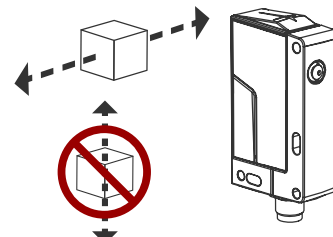

Figure 3. Sensing Beam Alignment

The reflector opposite the sensor must have a complete reflective surface that is at least 50 mm (2 in) wide and 30 mm (1.2 in) tall.

Mount the Sensor

1. If a bracket is needed, mount the sensor onto the bracket.
2. Mount the sensor (or the sensor and the bracket) to the machine or equipment at the desired location. Do not tighten the mounting screws at this time.
3. Check the sensor alignment.
4. Tighten the mounting screws to secure the sensor (or the sensor and the bracket) in the aligned position.

Wiring

Quick disconnect wiring diagrams are functionally identical.

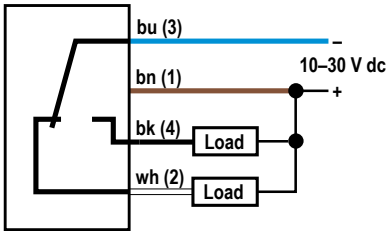

Figure 4. Complimentary NPN

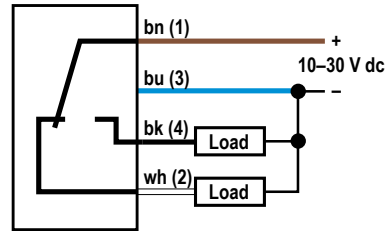

Figure 5. Complimentary PNP

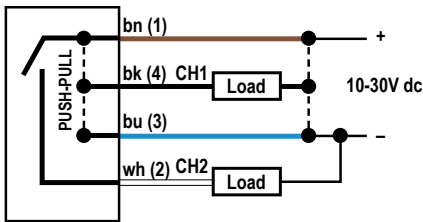
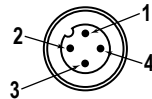

Figure 6. IO-Link



4-pin M12/Euro-style Models (Male)

- 1 = Brown
- 2 = White
- 3 = Blue
- 4 = Black

Configure the Sensor

Use the button to set the sensor sensitivity or switching behavior.



Important: Configure the sensor before the first use. The sensor is factory-set to the maximum operating range.

Sensitivity Setting	Max Range 100x100 reflector	Max Range 40x60 reflector	Minimum Object Detection Size
Standard	4.0 m	3.0 m	19 mm
Increased	4.0 m	3.0 m	12 mm
Increased with Fine Adjustment	4.0 m	3.0 m	8 mm

TEACH Sensor Sensitivity

Use the following procedure to set the sensor sensitivity as Standard or Increased.

Configure the sensor before it is used for the first time. The default setting is the maximum operating range.

- Standard sensitivity—the sensor switches when 28% of the sensing beam is covered by the object to be detected. Standard sensitivity is suitable for detection of opaque objects.
 - Increased sensitivity—the sensor switches when 18% of the sensing beam is covered by the object to be detected. Increased sensitivity is suitable for detection of containers with openings and transparent objects.
1. Make sure that the sensing beam is aligned with the center of the object and reflector.
 2. Clear the path to the reflector.
 3. Configure the sensitivity.

Sensitivity	Action	Result
Standard	Press and hold the TEACH button 2 to 7 seconds until both the green and the amber LEDs flash synchronously, then release the TEACH button.	TEACH Accepted Both LEDs remain on.
Increased	Press and hold the TEACH button 7 to 12 seconds until both the green and the amber LEDs flash alternately, then release the TEACH button.	TEACH Not Accepted The amber LED flashes. Repeat the Teach procedure.

The sensitivity is set and the sensor is ready for use.

TEACH Sensitivity Fine Adjustment

Use the following procedure to adjust the sensor sensitivity in small steps using the teach button during normal operation.

Sensitivity	Action	Result
Increase Sensitivity (reduce switching threshold)	Press and release the TEACH button (2 to 200 ms).	Sensitivity is increased slightly and the switching threshold is reduced slightly. The sensor confirms the button press by flashing both LEDs one time.
Reduce Sensitivity (increase switching threshold)	Press and hold the TEACH button 200 ms to 2 seconds, then release the TEACH button.	Sensitivity is reduced slightly and the switching threshold is increased slightly. The sensor confirms the button press by flashing both LEDs one time.

If the upper or lower end of the adjustment range is reached, both LEDs flash at a much higher frequency.

Select Light Operate/Dark Operate

Use the following procedure to change the sensor operation to light operate or dark operate for the desired application.

Action	Result
Press and hold the TEACH button for more than 12 seconds until the green LED flashes.	The amber LED indicates the current switching output setting with the beam clear. <ul style="list-style-type: none"> LED On = Output 1 light operate, Output 2 dark operate LED Off = Output 1 dark operate, Output 2 light operate
Release the TEACH button.	The change is complete.

Specifications

Sensing Range

0.4 m to 4.0 m (1.3 ft to 13.1 ft) with 100 × 100 mm reflector, BRT-92X92CB

Sensing Beam

Visible red LED, 620 nm

Operating Voltage

10 to 30 V DC, ≤15% residual ripple

Supply Protection Circuitry

Protected against reverse polarity and transient voltages

Output Protection Circuitry

Protected against output short-circuit, continuous overload, and false pulse on power-up

Output Configuration

Discrete output models

Solid-state complementary (SPDT): NPN or PNP (current sinking or sourcing), depending on model

IO-Link model

Channel 1 (Q1): IO-Link, Push/pull

Channel 2 (Q2): PNP (current sourcing) Dark Operate

Response Time

2 ms

Switching Frequency

250 Hz

Resolution

19 mm standard sensitivity
12 mm increased sensitivity
8 mm when increased sensitivity is manual adjusted

Delay at Start Up

<300 ms

Connection

Q5 models: 200 mm (7.5 in) PUR cable with a 4-pin M12/Euro-style quick disconnect

Q8 models: Integral M12/Euro-style quick disconnect

2M models: 2 m (6.5 ft) unterminated 4-wire PVC cable

Construction

Housing: PC-PBT

Lens cover: PMMA

Operating Conditions

Operating Temperature: -40 °C to +60 °C (-40 °F to +140 °F)

Storage Temperature: -40 °C to +70 °C (-40 °F to +158 °F)

Environmental Rating

IEC IP67, IEC IP69

Certifications



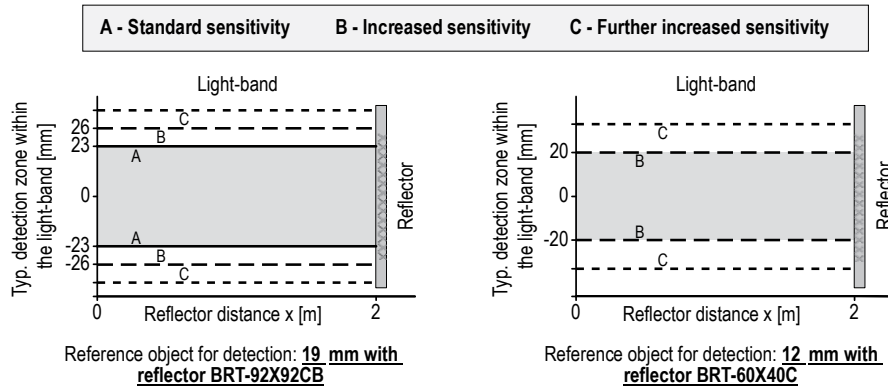
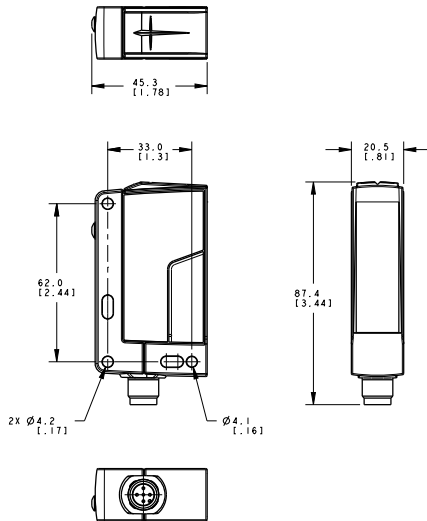

Figure 7. Sensitivity Diagrams

Dimensions

All measurements are listed in millimeters [inches], unless noted otherwise.

QD Models



Cable Models

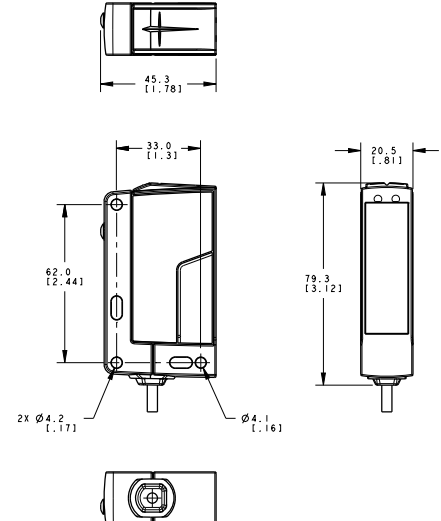

Accessories

Cordsets

4-Pin Threaded M12/Euro-Style Cordsets—Single Ended				
Model	Length	Style	Dimensions	Pinout (Female)
MQDC-406	2 m (6.56 ft)	Straight		
MQDC-415	5 m (16.4 ft)			
MQDC-430	9 m (29.5 ft)			
MQDC-450	15 m (49.2 ft)			

1 = Brown
2 = White
3 = Blue
4 = Black

4-Pin Threaded M12/Euro-Style Cordsets—Single Ended				
Model	Length	Style	Dimensions	Pinout (Female)
MQDC-406RA	2 m (6.56 ft)	Right-Angle		
MQDC-415RA	5 m (16.4 ft)			
MQDC-430RA	9 m (29.5 ft)			
MQDC-450RA	15 m (49.2 ft)			

Brackets

SMBQ76A

- Right-angle mounting bracket
- 14-ga Stainless Steel
- ± 12 degree tilt adjustment
- Clearance for M4 (#8) hardware

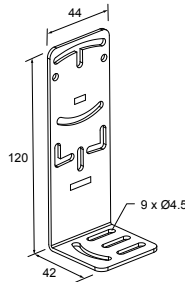

SMBQ76FAM12

- Swivel bracket with tilt and pan movement for precision adjustment
- Easy sensor mounting to extruded rail T-slots
- No bolt included. Mounts directly to 12 mm (1/2 in) rods

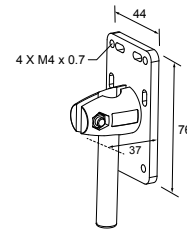

Reflectors

BRT-92X92CB

- Square, acrylic target with black mounting base
- Reflectivity Factor: 3.0
- Max. Temperature: +50 °C (+122 °F)
- Optional brackets are available
- Approximate size: 92 mm x 92 mm

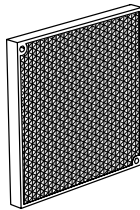

BRT-60X40C

- Rectangular, acrylic target
- Reflectivity Factor: 1.4
- Temperature: -20 °C to +60 °C (-4 °F to +140 °F)
- Optional brackets are available
- Approximate size: 40 mm x 60 mm

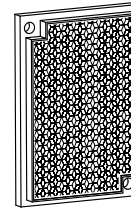

Banner Engineering Corp. Limited Warranty

Banner Engineering Corp. warrants its products to be free from defects in material and workmanship for one year following the date of shipment. Banner Engineering Corp. will repair or replace, free of charge, any product of its manufacture which, at the time it is returned to the factory, is found to have been defective during the warranty period. This warranty does not cover damage or liability for misuse, abuse, or the improper application or installation of the Banner product.

THIS LIMITED WARRANTY IS EXCLUSIVE AND IN LIEU OF ALL OTHER WARRANTIES WHETHER EXPRESS OR IMPLIED (INCLUDING, WITHOUT LIMITATION, ANY WARRANTY OF MERCHANTABILITY OR FITNESS FOR A PARTICULAR PURPOSE), AND WHETHER ARISING UNDER COURSE OF PERFORMANCE, COURSE OF DEALING OR TRADE USAGE.

This Warranty is exclusive and limited to repair or, at the discretion of Banner Engineering Corp., replacement. **IN NO EVENT SHALL BANNER ENGINEERING CORP. BE LIABLE TO BUYER OR ANY OTHER PERSON OR ENTITY FOR ANY EXTRA COSTS, EXPENSES, LOSSES, LOSS OF PROFITS, OR ANY INCIDENTAL, CONSEQUENTIAL OR SPECIAL DAMAGES RESULTING FROM ANY PRODUCT DEFECT OR FROM THE USE OR INABILITY TO USE THE PRODUCT, WHETHER ARISING IN CONTRACT OR WARRANTY, STATUTE, TORT, STRICT LIABILITY, NEGLIGENCE, OR OTHERWISE.**

Banner Engineering Corp. reserves the right to change, modify or improve the design of the product without assuming any obligations or liabilities relating to any product previously manufactured by Banner Engineering Corp. Any misuse, abuse, or improper application or installation of this product or use of the product for personal protection applications when the product is identified as not intended for such purposes will void the product warranty. Any modifications to this product without prior express approval by Banner Engineering Corp will void the product warranties. All specifications published in this document are subject to change; Banner reserves the right to modify product specifications or update documentation at any time. Specifications and product information in English supersede that which is provided in any other language. For the most recent version of any documentation, refer to: www.bannerengineering.com.

For patent information, see www.bannerengineering.com/patents.



more sensors, more solutions