

PVS28 Parts Verification Sensors



Visual Operator Guidance with Touchless Activation For Fast and Reliable Picking and Fulfillment Applications

- Provides optical sensing and intuitive indication in one device
- No controller needed — devices are completely self-contained
- Resistant to ambient light, EMI, and RFI interference
- Standard and additional colors plus animations available using Banner's Pro Editor software
- Available in 100 and 225 mm array lengths for small and large bins



Multicolor Operator Guidance

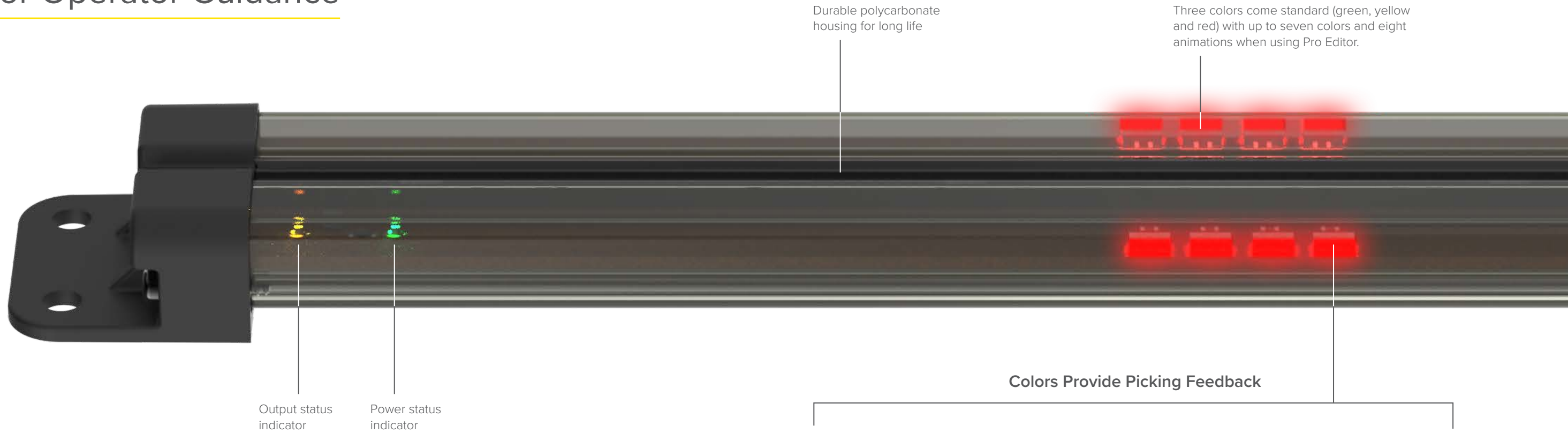

Colors Provide Picking Feedback

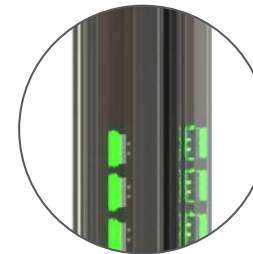

Guidance

The indicators turn green to quickly guide the operator to the correct part.

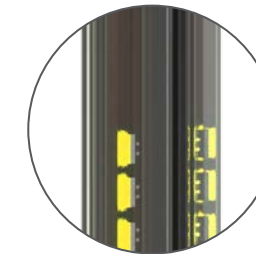

Correct Pick

The picker gets a yellow confirmation when picking from the correct bin.

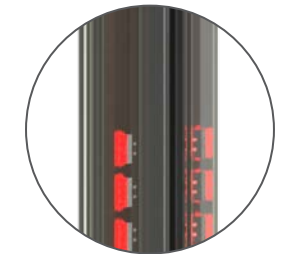

Mistake

A red mispick warning light notifies the operator when reaching into the wrong bin.

PRO Animations

Steady

Flash

Two Color Flash

50/50

Chase

50/50 Rotate

Intensity Sweep

Color Sweep

Colors:

- Green
- Red
- White
- Blue
- Cyan
- Yellow
- Magenta

Indication for Manual Bin Picking

Challenge

- Intensive training needed for employees
- Incorrectly picked items caused problems downstream
- An automated, intuitive solution was needed to guide pickers to the correct bins

Solution

- Intuitively guides the picker to the correct bin
- Picker is notified when reaching into the wrong bin
- Visual feedback for when the correct part has been picked
- Increases accuracy and decreases pick time



PVS28 Parts Verification Sensors

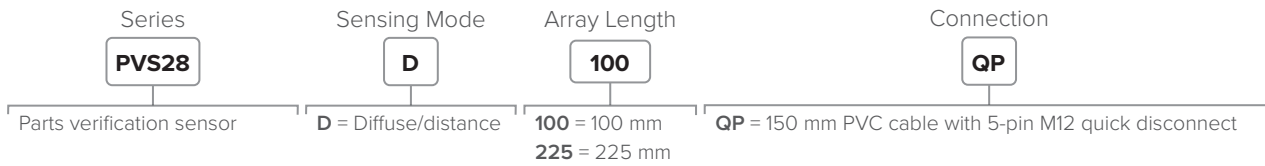

Specifications

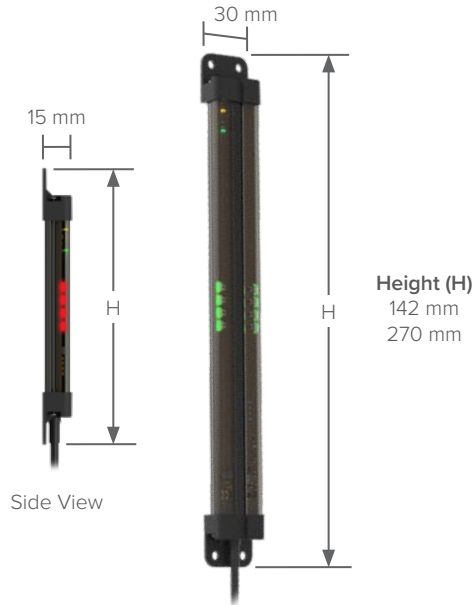

Supply Voltage	10 to 30 V DC
Range	Diffuse mode: 20–500 mm Retroreflective mode: 20–1000 mm
Response Time	Object Mode/Diffuse Mode Switching Frequency: 4 Hz Discrete Output Response: 120 ms Retroreflective Mode Switching Frequency: 2 Hz Discrete Output Response: 240 ms
Sensor Array and Beam Spacing	100 mm model: 2 sensors, 50 mm 225 mm model: 4 sensors, 60 mm
Construction	Housing: Polycarbonate End caps: ABS
Operating Conditions	–20 to +50 °C
Environmental Rating	IP54
Certifications	CE, UL LISTED, UK CA

Accessories



Pro Editor Accessories



4-Pin
MQDC-406
2 m (6.5')
MQDC-415
5 m (15')
MQDC-430
9 m (30')

5-Pin
MQDC1-506
2 m (6.5')
MQDC1-515
5 m (15')
MQDC1-530
9 m (30')

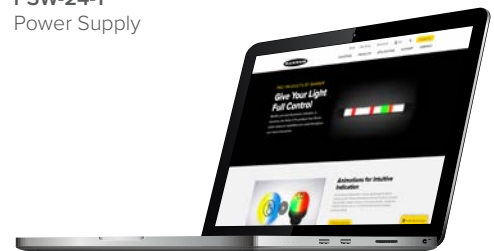

[Click here](#) for more information about Pro products



Banner Engineering Corp.

9714 10th Avenue North • Minneapolis, MN 55441 • 1-888-373-6767 • www.bannerengineering.com