

# DF-G3 Long Range Expert Dual Display Fiber Amplifier with Dual Discrete Outputs and IO Link

## Instruction Manual

Original Instructions  
193604 Rev. D  
20 March 2019  
© Banner Engineering Corp. All rights reserved



193604

# Contents

<b>1 Product Description</b>	<b>3</b>
1.1 Models	3
1.2 Overview	3
1.3 Top Panel Interface	4
<b>2 Installation Instructions</b>	<b>5</b>
2.1 Mounting Instructions	5
2.2 Installing the Fibers	5
2.3 Fiber Adapters	6
2.4 Wiring Diagrams	6
<b>3 Operating Instructions</b>	<b>7</b>
3.1 Run Mode	7
3.2 Program Mode	7
3.2.1 Output Selection	9
3.2.2 TEACH Selection	9
3.2.3 Response Speed	9
3.2.4 Offset Percent	10
3.2.5 Auto Thresholds	10
3.2.6 Delays/Timers	11
3.2.7 Sensitivity Selection	11
3.2.8 Display Readout	11
3.2.9 Gain Selection	11
3.2.10 Factory Defaults	11
3.3 Remote Input	12
3.4 Sync Master/Slave	12
3.5 Adjust Mode	12
3.5.1 TEACH Procedures	13
3.5.2 Troubleshooting	22
<b>4 IO-Link Interface</b>	<b>24</b>
<b>5 Specifications</b>	<b>25</b>
5.1 Excess Gain Curves	26
5.2 Beam Patterns	28
5.3 Dimensions	30
<b>6 Accessories</b>	<b>31</b>
6.1 Quick-Disconnect Cordsets—Single Output Models	31
<b>7 Banner Engineering Corp. Limited Warranty</b>	<b>33</b>

# 1 Product Description

*Advanced Sensor with Dual Displays for use with Plastic and Glass Fiber Optic Assemblies*

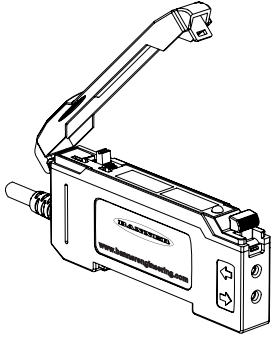

- World-class long-range sensing capability, more than 3 m (10 ft) with opposed mode fibers
- Models with high visibility red or extreme high-power infrared sensing beams available
- Cross-talk avoidance function allows seven inspections in dense sensing point applications
- Energy efficient light resistance enables stable detection in industrial lighting environments
- High power amplifier with small core fibers enables precise position sensing of small components
- Easy to read dual digital displays show both signal level and threshold simultaneously
- Lever action fiber clamp provides stable, reliable and trouble-free fiber clamping
- Simple user interface ensures easy sensor set-up and programming through displays and switches/buttons or remote input teach wire
- Expert TEACH and SET methods ensure optimal gain and threshold for all applications, especially for high speed or low contrast applications
- User has full control over all operating parameters: threshold, Light Operate or Dark Operate, output timing functions, gain level, and response speed
- Thermally stable electronics shortens start-up time and maintains signal stability during operation
- ECO (economy) display reduces amplifier power consumption by 25%
- Sleek 10 mm wide housing mounts to 35 mm DIN rail



## WARNING:

- **Do not use this device for personnel protection**
- Using this device for personnel protection could result in serious injury or death.
- This device does not include the self-checking redundant circuitry necessary to allow its use in personnel safety applications. A device failure or malfunction can cause either an energized (on) or de-energized (off) output condition.

## 1.1 Models

Models <sup>1</sup>	Sensing Beam Color	Reference Sensing Range <sup>2</sup>	Channel 1	Channel 2	Connector
DF-G3-KD-2M	Visible Red	3000 mm	IO-Link, push/pull output	PNP only output, or input	2 m (6.5 ft) cable, 4-wire
DF-G3IR-KD-2M	Infrared, 850 nm	6000 mm			

## 1.2 Overview

The DF-G3 is an easy-to-use, DIN-rail-mountable fiber optic sensor offering world-class long-range sensing capability. It provides high-performance sensing in long range or precise position sensing applications.

- <sup>1</sup>
- To order the 150 mm (6 in) PVC cable model with a 4-pin M8/Pico-style quick disconnect, replace the suffix "2M" with "Q3" in the model number. For example, DF-G3-KD-Q3.
  - To order the 150 mm (6 in) PVC cable model with a 4-pin M12/Euro-style quick disconnect, replace the suffix "2M" with "Q5" in the model number. For example, DF-G3-KD-Q5.
  - To order the 4-pin M8/Pico-style integral quick disconnect model, replace the suffix "2M" with "Q7" in the model number. For example, DF-G3-KD-Q7.
  - Models with a quick disconnect require a mating cordset.

- <sup>2</sup> Excess gain = 1, Long Range response speed, opposed mode sensing. PIT46U plastic fiber used for visible LED models, IT.83.3ST5M6 glass fiber used for IR model.

The sensor's compact housing has dual digital displays (Red/Green) and a bright output LED for easy programming and status monitoring during operation. The sensor features a push-pull primary output which supports IO-link communication, and a multi-function secondary independent PNP output which can be configured as an input for advanced sensor configuration and remote teach.

The DF-G3 features improved temperature compensation compared with previous fiber optic sensors. An accessory clamp is available to secure a bank of connected sensors together on a DIN rail (see Accessories).



Figure 1. DF-G3 IO Link Model Features

1. Output LED
2. CH1/CH2 Switch
3. RUN/PRG/ADJ Mode Switch
4. Lever Action Fiber Clamp
5. Red Signal Level
6. Green Threshold
7. +/-SET/- Rocker Button

## 1.3 Top Panel Interface

Opening the dust cover provides access to the top panel interface. The top panel interface consists of the RUN/PRG/ADJ mode switch, CH1/CH2 switch, +/-SET/- rocker button, dual red/green digital displays, and output LED.



### RUN/PRG/ADJ Mode Switch

The RUN/PRG/ADJ mode switch puts the sensor in RUN, PRG (Program), or ADJ (Adjust) mode.

- RUN mode allows the sensor to operate normally and prevents unintentional programming changes via the +/-SET/- rocker button.
- PRG mode allows the sensor to be programmed through the display-driven programming menus (see [Program Mode](#) on page 7)
- ADJ mode allows the user to perform Expert TEACH/SET methods and Manual Adjust (see Adjust Mode).

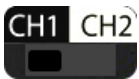

### CH1/CH2 Switch (Dual Output Mode)

The CH1/CH2 switch selects which output's parameters can be accessed and changed in the interface of the display.

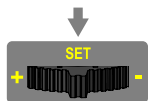

### +/-SET/- Rocker Button

The +/-SET/- rocker button is a 3-way button. The +/- positions are engaged by rocking the button left/right. The SET position is engaged by clicking down the button while the rocker is in the middle position. All three button positions are used during PRG mode to navigate the display-driven programming menu. During ADJ mode, SET is used to perform TEACH/SET methods and +/- are used to manually adjust the threshold(s). The rocker button is disabled during RUN mode, except when using Window SET.



### Red/Green Digital Displays

During RUN and ADJ modes, the Red display shows the signal level, and the Green display shows the threshold or the total counts. During PRG mode, both displays are used to navigate the display-driven programming menu.



### Dual Output LEDs

The output LEDs provide a visible indication when the associated output is active (conducting).

- 1 represents the Channel 1 output
- 2 represents the Channel 2 output

## 2 Installation Instructions

### 2.1 Mounting Instructions

#### Mount on a DIN Rail

1. Hook the DIN rail clip on the bottom of the DF-G3 over the edge of the DIN rail (1).
2. Push the DF-G3 up on the DIN rail (1).
3. Pivot the DF-G3 onto the DIN rail, pressing until it snaps into place (2).

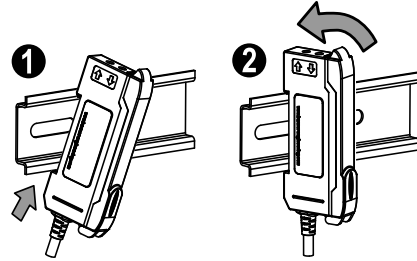

#### Mount to the Accessory Bracket (SA-DIN-BRACKET)

1. Position the DF-G3 in the SA-DIN-BRACKET.
2. Insert the supplied M3 screws.
3. Tighten the screws.

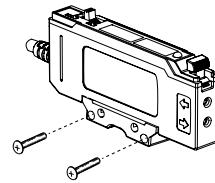

#### Remove from a DIN rail

1. Push the DF-G3 up on the DIN rail (1).
2. Pivot the DF-G3 away from the DIN rail and remove it (2).

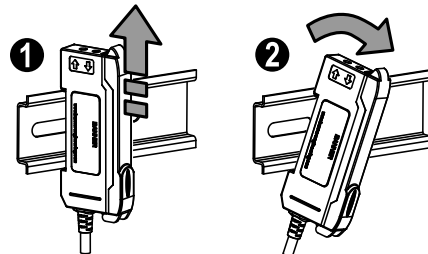

### 2.2 Installing the Fibers

Follow these steps to install glass or plastic fibers.

1. Open the dust cover.
2. Move the fiber clamp forward to unlock it.
3. Insert the fiber(s) into the fiber port(s) until they stop.
4. Move the fiber clamp backward to lock the fiber(s).
5. Close the dust cover.

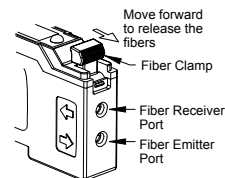

**Note:** For optimum performance of IR models, if applicable, glass fibers must be used.

## 2.3 Fiber Adapters



**Note:** If a thin fiber with less than 2.2 mm outer diameter is used, install the fiber adapter provided with the fiber assembly to ensure a reliable fit in the fiber holder. Align the fibers to the end of the adapters. Banner includes the adapters with all fiber assemblies.

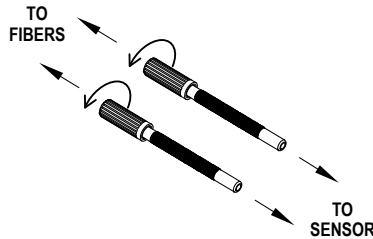

Fiber Outer Diameter (mm)	Adapter Color
Ø 1.0	Black
Ø 1.3	Red
Ø 2.2	No adapter needed

When connecting coaxial-type fiber assemblies to the amplifier, install the single-core (center) fiber to the Transmitter port, and the multi-core (outer) fiber to the Receiver port. This will result in the most reliable detection.

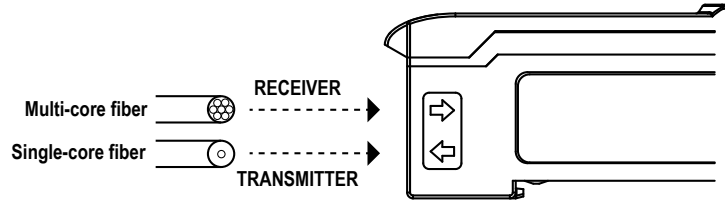

## 2.4 Wiring Diagrams

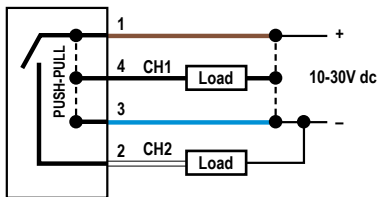

Figure 2. Channel 1 as a Push-Pull discrete output, Channel 2 as PNP discrete output

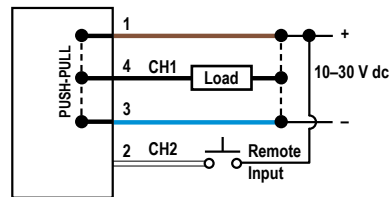

Figure 3. Channel 1 as a Push-Pull discrete output, Channel 2 as remote input

**Key**  
 1 = Brown  
 2 = White  
 3 = Blue  
 4 = Black



**Note:** Open lead wires must be connected to a terminal block.



**Note:** The Channel 2 wire function is user-selectable. The default is independent Light Operate (LO) PNP output. See the Remote Input section for details regarding use as remote input or the Sync Master/Slave section for use as a synchronization output.

## 3 Operating Instructions

### 3.1 Run Mode

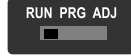

---

Run mode allows the sensor to operate normally and prevents unintentional programming changes. The +/-SET/- rocker button is disabled during RUN mode, except when using Window SET.

### 3.2 Program Mode



---

Program (PRG) mode allows the following settings to be programmed in the DF-G3.

**CH 1 Factory Default Settings:**

Setting	Factory Default
Out SEL1	LO
tch SEL1	2-pt tch
rESP SPd	2 mS
OFSt Pct1	10 Pct
Auto thr1	oFF
dLY SEL1	oFF
SEnS SEL1	Std
diSP rEAd	diSP 1234
GAin SEL	Auto

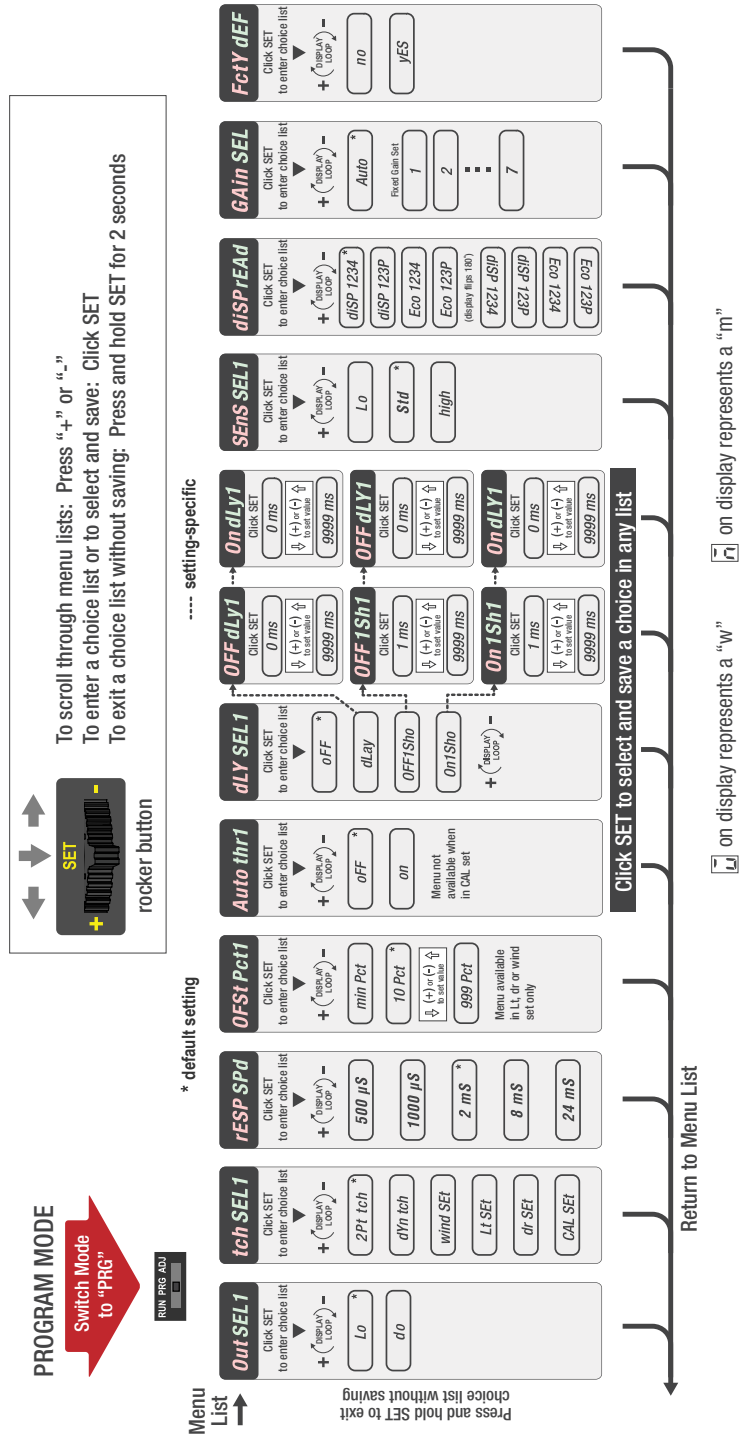

Figure 4. CH 1 Program Mode Chart



CH 2 Factory Default Settings:

Setting	Factory Default
Out SEL2	LO
tch SEL2	2-pt tch
OFSt Pct2	10 Pct
Auto thr2	oFF
dLY SEL2	oFF
SEnS SEL2	Std

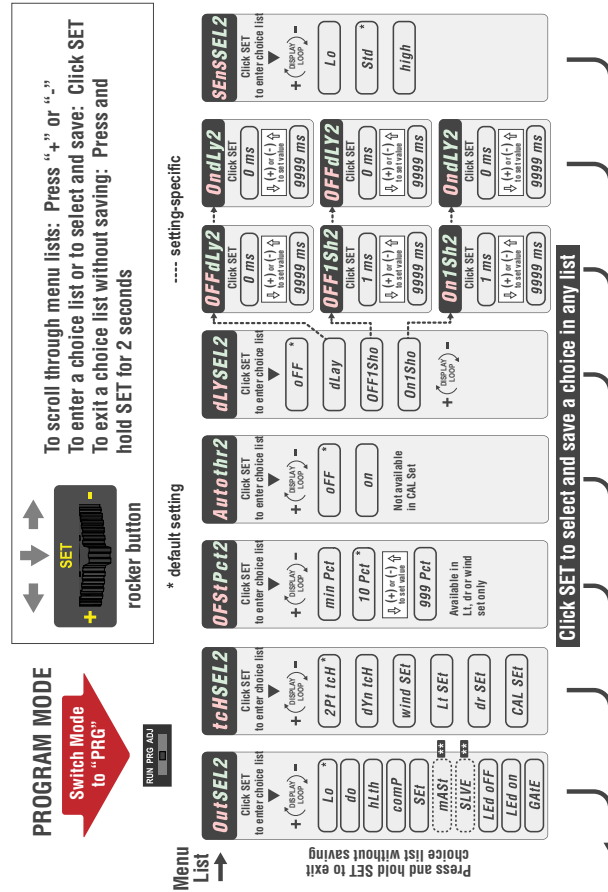

Figure 5. CH 2 Program Mode Chart

### 3.2.1 Output Selection Out SEL1

Both CH1 and CH2 can be programmed for either light operate (LO) or dark operate (DO). The Channel 2 menu includes additional options: Health (Health Mode Alarm), Comp (Complementary Programming), Set (sets Channel 2 wire as a remote input), Mast (selects this unit as the master and then allows you to enter the total number of slaves there will be), Slave (selects this unit as a slave and then allows you to enter this slave address), LED off, LED on and Gate.

### 3.2.2 TEACH Selection tch SEL1

The DF-G3 can be programmed for one of the following TEACH/SET methods:

- Two-Point TEACH
- Dynamic TEACH
- Window SET
- Light SET
- Dark SET
- Calibration SET



**Note:** A TEACH Selection must be selected by programming before TEACH/SET methods can be used.

### 3.2.3 Response Speed RESP SPD

The DF-G3 can be programmed for one of the following Response Speeds:

Description	Response Speed	Repetition Period	Repeatability	Cross-Talk Avoidance	Energy Efficient Light Resistance	Maximum Range, Red <sup>3</sup>	Maximum Range, IR850 <sup>4</sup>
High Speed	500 $\mu$ s	100 $\mu$ s	100 $\mu$ s	No	No	1200 mm	2400 mm
Fast	1000 $\mu$ s	100 $\mu$ s	150 $\mu$ s	Yes	No	1500 mm	3000 mm
Standard	2 ms	100 $\mu$ s	180 $\mu$ s	Yes	Yes	1500 mm	3000 mm
Long Range	8 ms	100 $\mu$ s	180 $\mu$ s	Yes	Yes	1950 mm	3900 mm
Extra Long Range	24 ms	100 $\mu$ s	180 $\mu$ s	Yes	Yes	3000 mm	6000 mm

### 3.2.4 Offset Percent

The Offset Percent is used during the Window, Light, or Dark SET methods. The threshold(s) are positioned a programmable % offset from the taught condition.

The allowable offset percent range varies based on the teach method and sensitivity settings as shown below:

Teach Method	Response Speed	Sensitivity	Offset % Range
Window Set, Light Set	500 $\mu$ s, 1000 $\mu$ s, 2 ms, 8 ms, 24 ms	High	1 to 99%
		Standard	2 to 98%
		Low	5 to 95%
Dark Set	500 $\mu$ s, 1000 $\mu$ s, 2 ms, 8 ms, 24 ms	High	1 to 999%
		Standard	2 to 999%
		Low	5 to 999%

### 3.2.5 Auto Thresholds

Auto Thresholds can be programmed to be ON/OFF. The Auto Thresholds algorithm continuously tracks slow changes in the taught condition(s), and optimizes the threshold(s) to provide for reliable sensing. For Two-Point and Dynamic TEACH, the algorithm optimizes the threshold to be centered between the light and dark conditions. For Window, Light, and Dark SET, the algorithm optimizes the threshold(s) to maintain the programmed Offset Percent from the taught condition.

- After programming Auto Thresholds to ON, it is highly recommended to re-perform the TEACH/SET method
- Manual Adjustments are disabled when Auto Thresholds are ON
- Auto Thresholds are automatically disabled in Calibration SET (see [Calibration SET](#) on page 21)
- Severe contamination/changes in the taught condition can prevent the Auto Thresholds algorithm from optimizing the threshold(s). If this occurs, the DF-G3 enters a **Threshold Alert** or **Threshold Error** state. See [Troubleshooting](#) on page 22 for more explanation.

<sup>3</sup> Excess gain = 1 (high sensitivity), opposed mode sensing. PIT46U plastic fiber used for visible LED models.

<sup>4</sup> Excess gain = 1 (high sensitivity), opposed mode sensing. IT.83.3ST5M6 glass fiber used for IR models.

### 3.2.6 Delays/Timers OFF dLY1 OFF 1Sh1 On dLY1 On dLY1

ON/OFF Delays and ON/OFF One-Shot timers can be programmed independently for both CH1 and CH2 for a time period between 1 - 9999 ms (a value of 0 disables the delay/timer). *Figure 6* on page 11 defines how the delays/timers affect the output behavior.

Some combinations of delays/timers are not allowed. The DF-G3 programming menu automatically disables invalid combinations of delays/timers. The following table shows the allowable combinations of delays/timers:

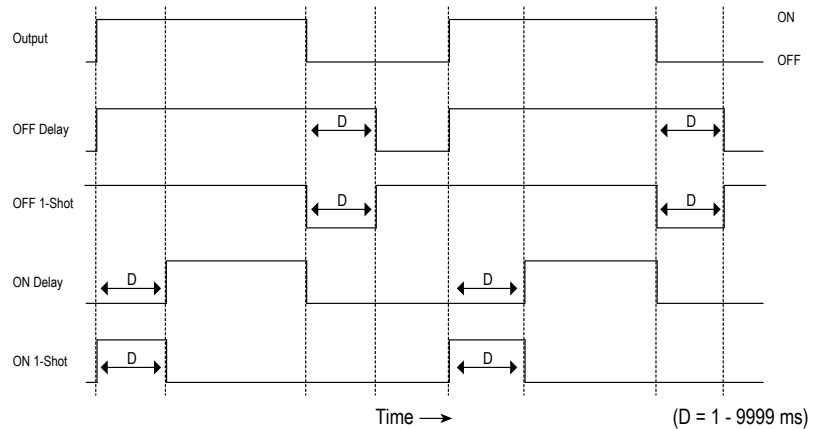

Figure 6. DF-G3 Delays/Timers

	OFF Delay	OFF One-Shot Timer	ON Delay	ON One-Shot Timer
<b>OFF Delay</b>	-	OK	OK	N/A
<b>OFF One-Shot Timer</b>	OK	-	N/A	N/A
<b>ON Delay</b>	OK	N/A	-	OK
<b>ON One-Shot Timer</b>	N/A	N/A	OK	-

### 3.2.7 Sensitivity Selection SEn SEL1

The Sensitivity Selection can be programmed independently for CH1 and CH2. Use this setting to increase (lo) or decrease (high) the switch-point hysteresis from the default (std) setting.

- high—High sensitivity. Use this setting for low contrast sensing
- Std—Standard sensitivity
- Lo—Low sensitivity. Use this setting to stabilize the output in high vibration applications

### 3.2.8 Display Readout dISP rEAd

The readout of the digital displays can be programmed for the following options:

- Signal/Threshold readout - Numeric (1234) or % (123P)
- ECO mode - Enabled or Disabled (ECO mode dims the displays to reduce current consumption)
- Display Orientation - Normal (1234) or Flipped (ɹƎƆ1)

### 3.2.9 Gain Selection GAIn SEL

The DF-G3 can operate in Auto Gain mode or the Gain can be fixed to be in Gain GAIn SEL. In Auto Gain, the DF-G3 optimizes the gain during a TEACH/SET method for the presented condition(s). While viewing the fixed gains in the Gain Selection choice list, the DF-G3 will automatically switch to the selected gain and display the measured signal on the Red display. This allows for easy and quick evaluation of the fixed gain mode.

### 3.2.10 Factory Defaults FACTY dEF

The Factory Defaults menu allows the DF-G3 to be easily restored back to original factory default settings (see **Factory Default Settings** in Program Mode).

### 3.3 Remote Input

Use the input wire to program the sensor remotely. To program the sensor using the input wire, remote input must be enabled (inPT SEL = SEt). The remote input provides limited programming options (see the figure below). Pulse the remote input according to the figures and the instructions provided in this manual.

**Note:** For NPN models, the remote input pulses are active low as shown in the following figures. For PNP models, the remote input pulses are active high and are inverted from the following figures.

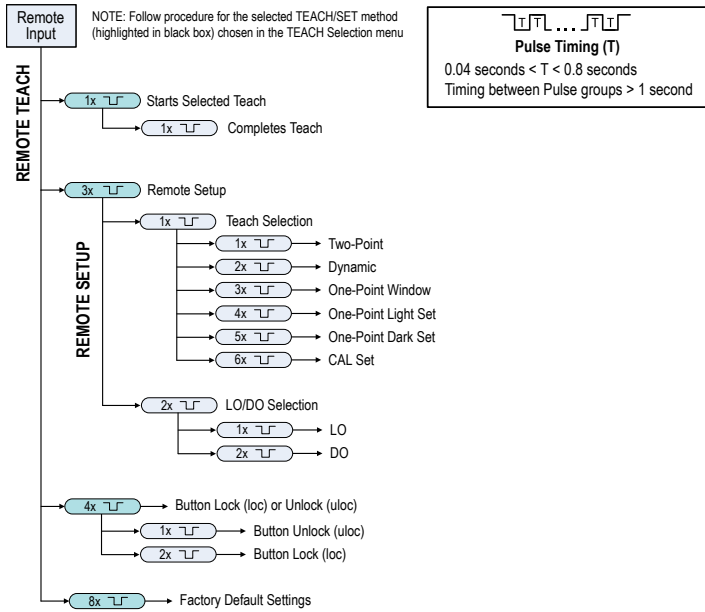

Figure 7. Single Output – Remote Input Flowchart

### 3.4 Sync Master/Slave

Up to seven DF-G3 sensors may be used together in a single sensing application. To eliminate crosstalk between the sensors, configure one sensor to be the master and the remaining sensors to be the slaves. In this mode, the sensors alternate taking measurements and the response speed is 2 ms.

**Note:** Note: In this mode, all sensors must either be NPN or PNP output models.

1. Configure the first sensor as the Master (inPt SEL = MAST).
2. In the Master sensor set-up, enter the total number of Slave sensors you will be using (toTL SLAV = 1 - 6).
3. For each Slave sensor used, configure the input as a Slave (inPt SEL = SLVE).
4. Give each Slave its own identifying address (SLAV Addr = 1 - 6).
5. Connect the Input wires of the Master and all of the Slaves together.

**Note:** Note: Giving two Slave sensors the same address will cause them to fire their emitters at the same time in the firing sequence.

### 3.5 Adjust Mode



Sliding the RUN/PRG/ADJ mode switch to the ADJ position allows the user to perform Expert TEACH/SET methods and Manual Adjustment of the threshold(s).



**Note:** For the Dual Output models, when teaching CH2, the gain setting will be the same as the gain setting made during the CH1 teach. Reteaching CH1 may invalidate the previous CH2 teach.

### 3.5.1 TEACH Procedures

The instruction manual has detailed instructions for these TEACH modes:

- Two-Point TEACH
- Dynamic TEACH
- Window SET
- Light SET
- Dark SET
- Calibration SET

#### Two-Point TEACH

- Establishes a single switching threshold
- Threshold can be adjusted by using the "+" and "-" rocker button (Manual Adjust)

Two-Point TEACH is used when two conditions can be presented statically to the sensor. The sensor locates a single sensing threshold (the switch point) midway between the two taught conditions, with the Output ON condition on one side, and the Output OFF condition on the other.

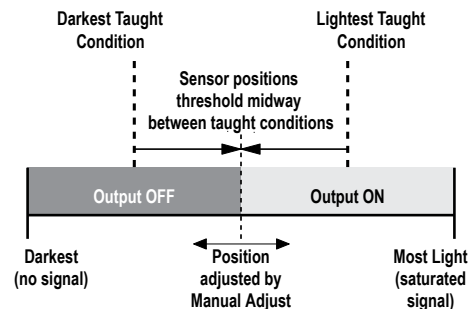

Figure 8. Two-Point TEACH (Light Operate shown)

The Output ON and OFF conditions can be reversed by using the LO/DO (Light Operate/ Dark Operate) switch.

The Output ON and OFF conditions can be reversed by using the LO/DO (Light Operate/ Dark Operate) switch or through the program interface for the dual output model.

#### Two-Point TEACH and Manual Adjust

Moves switching threshold value up or down to make adjustments

- Slide Mode switch to ADJ to enter Adjust mode
- Press "+" to increase; press "-" to decrease
  - GREEN display shows the switching threshold value
  - 2 seconds after adjustment, the GREEN display will flash 3 times to confirm
- Slide Mode switch to RUN to complete operation



**Remember:** Manual adjustments are disabled when Auto Thresholds are ON

Follow these steps to perform a Two-Point TEACH:





**Note:** TEACH Selection must be programmed to **2Pt tch**.





1. Enter Adjust mode.

Method	Action	Result
SET Button <sup>5</sup>	Set the Mode switch to ADJ. 	Display: Red - Signal Level; Green - Threshold 
Remote Input <sup>6</sup>	No action is required; sensor is ready for the Two-Point TEACH method	



2. Teach the first condition.

Method	Action	Result
SET Button	a. Present the first condition. b. Click the SET rocker button. 	Display: Flashes "2Pt tch" then holds on "1234 2nd" 
Remote Input	a. Present the first condition. b. Single-pulse the remote input. 	

3. Teach the second condition.

Method	Action	Result
SET Button	a. Present the second condition. b. Click the SET rocker button. 	<b>TEACH Accepted</b> Displays alternate "PASS" and % Minimum Difference <sup>7</sup> ; Sensor returns to Adjust mode 
Remote Input	a. Present the second condition. b. Single-pulse the remote input. 	<b>TEACH Not Accepted</b> Displays alternate "FAIL" and % Minimum Difference <sup>7</sup> ; Sensor returns to Adjust mode 

4. Return to Run mode.

Method	Action	Result
SET Button	Move the Mode switch to RUN 	Display: Red - Signal Level; Green - Threshold 
Remote Input	No action is required; sensor returns to RUN mode automatically	

### Dynamic TEACH

- Teaches on-the-fly
- Establishes a single switching threshold
- Threshold can be adjusted using "+" and "-" rocker button (Manual Adjust)

Dynamic TEACH is best used when a machine or process may not be stopped for teaching. The sensor learns during actual sensing conditions, taking multiple samples of the light and dark conditions and automatically setting the threshold at the optimum level.

<sup>5</sup> SET Button: 0.04 seconds ≤ "Click" ≤ 0.8 seconds

<sup>6</sup> Remote Input: 0.04 seconds ≤ T ≤ 0.8 seconds

<sup>7</sup> See [Troubleshooting](#) on page 22 for more explanation of the % Minimum Difference displayed after the Two-Point TEACH method.

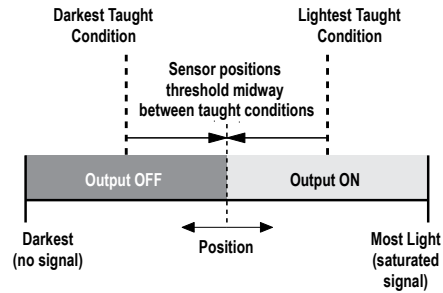

Figure 9. Dynamic TEACH (Light Operate shown)

The output ON and OFF conditions can be reversed using the LO/DO switch.

The Output ON and OFF conditions can be reversed by using the LO/DO (Light Operate/ Dark Operate) switch or through the program interface for the dual output model.

### Dynamic TEACH and Manual Adjust

Moves switching threshold value up or down to make adjustments

- Slide Mode switch to ADJ to enter Adjust mode
- Press "+" to increase; press "-" to decrease
  - GREEN display shows the switching threshold value
  - 2 seconds after adjustment, GREEN display will flash 3 times to confirm
- Slide Mode switch to RUN to complete operation



**Remember:** Manual adjustments are disabled when Auto Thresholds are ON

Follow these steps to perform **Dynamic TEACH**:



**Note:** TEACH Selection must be programmed to **dYn tch**.

1. Enter Adjust Mode.

Method	Action	Result
SET Button <sup>8</sup>	Set Mode switch to ADJ	Display: Red - Signal Level; Green - Threshold 
Remote Input <sup>9</sup>	No action required; sensor is ready for Dynamic TEACH method	

2. Enter Dynamic TEACH.

Method	Action	Result
SET Button	Click the SET rocker button	Display: Flashes "dYn tch" then holds on "1234 dYn" 
Remote Input	Single-pulse remote input	



3. Present ON and OFF Conditions.

<sup>8</sup> SET Button: 0.04 seconds ≤ "Click" ≤ 0.8 seconds

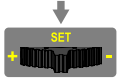

<sup>9</sup> Remote Input: 0.04 seconds ≤ T ≤ 0.8 seconds

Method	Action	Result
SET Button	Present ON and OFF conditions	Display: Red - Signal Level; Green - Threshold 
Remote Input	Present ON and OFF conditions	

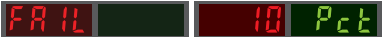
4. Exit Dynamic TEACH.

Method	Action	Result
SET Button	Click the SET rocker button 	<b>TEACH Accepted</b> Displays alternate "PASS" with % Minimum Difference <sup>10</sup> , Sensor returns to Adjust mode
Remote Input	Single-pulse remote input 	 <b>TEACH Not Accepted</b> Displays alternate "FAIL" with % Minimum Difference <sup>10</sup> , Sensor returns to Adjust mode 

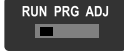
5. Return to RUN Mode.

Method	Action	Result
SET Button	Move Mode switch to RUN 	Display: Red - Signal Level; Green - Threshold 
Remote Input	No action required; sensor returns to RUN mode automatically	

## Window SET

- Sets window thresholds that extend a programmable % offset above and below the presented condition
- All other conditions (lighter or darker) cause the output to change state
- Sensing window center can be adjusted using "+" and "-" rocker button (Manual Adjust)
- Recommended for applications where a product may not always appear in the same place, or when other signals may appear
- See Program Mode for programming the Offset Percent setting

A single sensing condition is presented, and the sensor positions window thresholds a programmable % offset above and below the presented condition. In LO mode, Window SET designates a sensing window with the Output ON condition inside the window, and the Output OFF conditions outside the window.

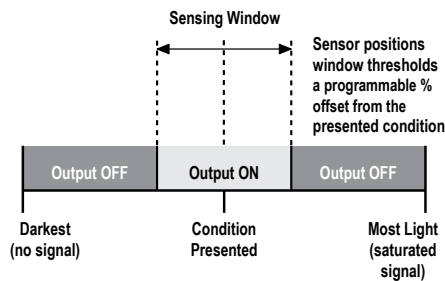

Figure 10. Window SET (Light Operate shown)

<sup>10</sup> See [Troubleshooting](#) on page 22 for more explanation of the % Minimum Difference displayed after the Dynamic TEACH method.



Output ON and OFF conditions can be reversed using the LO/DO switch.

The Output ON and OFF conditions can be reversed by using the LO/DO (Light Operate/ Dark Operate) switch or through the program interface for the dual output model.

### Window SET and Manual Adjust

Moves sensing window center value up or down to make adjustments

- Slide Mode switch to ADJ to enter Adjust mode
- Press "+" to increase; press "-" to decrease
  - GREEN display shows the sensing window center value
  - 2 seconds after adjustment, the GREEN display will flash 3 times to confirm
- Slide Mode switch to RUN to complete operation





**Remember:** Manual adjustments are disabled when Auto Thresholds are ON

Follow these steps to perform a Window SET:







**Note:** TEACH Selection must be programmed to **wind SET**.

#### 1. Enter Adjust Mode

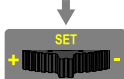
Method	Action	Result
SET Button <sup>11</sup>	Set Mode switch to ADJ 	Display: Red - Signal Level; Green - Threshold 
Remote Input <sup>12</sup>	No action required; sensor is ready for Window SET method	

#### 2. SET Sensing Condition



Method	Action	Result
SET Button	<ul style="list-style-type: none"> <li>• Present sensing condition</li> <li>• Click the SET rocker button </li> </ul>	<p><b>Threshold Condition Accepted</b> Displays read "wind SET" then alternate "PASS" with % Offset<sup>13</sup>; Sensor returns to Adjust mode</p>  <p><b>Threshold Condition Not Accepted</b> Displays read "wind SET" then alternate "FAIL" with minimum % Offset<sup>13</sup> for sensing condition; Sensor returns to Adjust mode</p> 
Remote Input	<ul style="list-style-type: none"> <li>• Present sensing condition</li> <li>• Single-pulse the remote input </li> </ul>	

#### 3. Return to RUN Mode

<sup>11</sup> SET Button: 0.04 seconds ≤ "Click" ≤ 0.8 seconds

<sup>12</sup> Remote Input: 0.04 seconds ≤ T ≤ 0.8 seconds

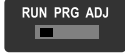
<sup>13</sup> See [Troubleshooting](#) on page 22 for more explanation of the % Offset displayed after the Window SET method

Method	Action	Result
SET Button	Move Mode switch to Run 	Display: Red - Signal Level; Green - Window Center (see <a href="#">Figure 11</a> on page 18 for instructions on how to display upper and lower thresholds)
Remote Input	No action required; sensor returns to Run mode automatically	

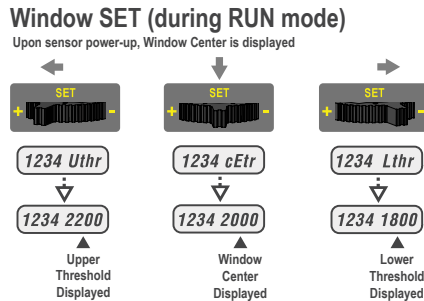

Figure 11. Upper and Lower Thresholds

### Light SET

- Sets a threshold a programmable % offset below the presented condition
- Changes output state on any condition darker than the threshold condition
- Threshold can be adjusted using "+" and "-" rocker button (Manual Adjust)
- Recommended for applications where only one condition is known, for example a stable light background with varying darker targets
- See Program Mode for programming the Offset Percent setting

A single sensing condition is presented, and the sensor positions a threshold a programmable % offset below the presented condition. When a condition darker than the threshold is sensed, the output either turns ON or OFF, depending on the LO/DO setting.

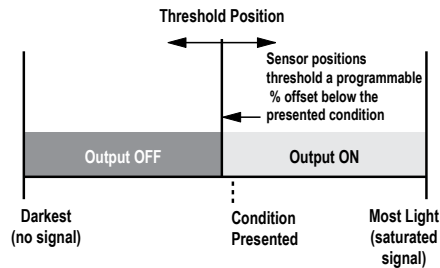

Figure 12. Light SET (Light Operate shown)

### Light SET and Manual Adjust

Moves switching threshold value up or down to make adjustments

- Slide Mode switch to ADJ to enter Adjust mode
- Press "+" to increase; press "-" to decrease
  - GREEN display shows the switching threshold value
  - 2 seconds after adjustment, the GREEN display will flash 3 times to confirm
- Slide Mode switch to RUN to complete operation



**Remember:** Manual adjustments are disabled when Auto Thresholds are ON

Follow these steps to perform a Light SET:







**Note:** TEACH Selection must be programmed to **Lt SET**.



1. Enter Adjust Mode

Method	Action	Result
SET Button <sup>14</sup>	Set Mode switch to ADJ 	Display: Red - Signal Level; Green - Threshold 
Remote Input <sup>15</sup>	No action is required; sensor is ready for Light SET method	

2. SET Sensing Condition

Method	Action	Result
SET Button	<ul style="list-style-type: none"> <li>Present sensing condition</li> <li>Click the SET rocker button</li> </ul> 	<p><b>Threshold Condition Accepted</b> Displays read "Lt SET" then alternate "PASS" with % Offset<sup>16</sup>; Sensor returns to Adjust mode</p> 
Remote Input	<ul style="list-style-type: none"> <li>Present sensing condition</li> <li>Single-pulse the remote input</li> </ul> 	<p><b>Threshold Condition Not Accepted</b> Displays read "Lt SET" then alternate "FAIL" with minimum % Offset<sup>16</sup> for sensing condition; Sensor returns to Adjust mode</p> 

3. Return to RUN Mode

Method	Action	Result
SET Button	Move Mode switch to RUN 	Display: Red - Signal Level; Green - Threshold 
Remote Input	No action required; sensor returns to RUN mode automatically	

## Dark SET

- Sets a threshold a programmable % offset above the presented condition
- Any condition lighter than the threshold condition causes the output to change state
- Threshold can be adjusted using "+" and "-" rocker button (Manual Adjust)
- Recommended for applications where only one condition is known, for example a stable dark background with varying lighter targets
- See Program Mode for programming the Offset Percent setting



**Note:** Offset Percent MUST be programmed to **Minimum Offset** to accept conditions of no signal (0 counts).

A single sensing condition is presented, and the sensor positions a threshold a programmable % offset above the presented condition. When a condition lighter than the threshold is sensed, the output either turns ON or OFF, depending on the LO/DO setting.

<sup>14</sup> SET Button: 0.04 seconds ≤ "Click" ≤ 0.8 seconds

<sup>15</sup> Remote Input: 0.04 seconds ≤ T ≤ 0.8 seconds

<sup>16</sup> See [Troubleshooting](#) on page 22 for more explanation of the % Offset displayed after the Light SET method

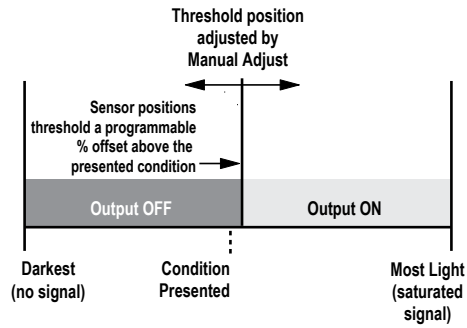

Figure 13. Dark SET (Light Operate shown)

### Dark SET and Manual Adjust

Moves switching threshold value up or down to make adjustments

- Slide Mode switch to ADJ to enter Adjust mode
- Press "+" to increase; press "-" to decrease
  - GREEN display shows the switching threshold value
  - 2 seconds after adjustment, the GREEN display will flash 3 times to confirm
- Slide Mode switch to RUN to complete operation





**Remember:** Manual adjustments are disabled when Auto Thresholds are ON

Follow these steps to perform a Dark SET:







**Note:** TEACH Selection must be programmed to **dr SET**.

1. Enter Adjust Mode.

Method	Action	Result
SET Button <sup>17</sup>	Set Mode switch to ADJ 	Display: Red - Signal Level; Green - Threshold 
Remote Input <sup>18</sup>	No action required; sensor is ready for Dark SET method	

2. SET Sensing Condition.

Method	Action	Result
SET Button	<ul style="list-style-type: none"> <li>• Present sensing condition</li> <li>• Click the SET rocker button</li> </ul> 	<p><b>Threshold Condition Accepted</b> Displays read "dr SET" then alternate "PASS" with % Offset<sup>19</sup>; Sensor returns to Adjust mode</p> 
Remote Input	<ul style="list-style-type: none"> <li>• Present sensing condition</li> <li>• Single-pulse the remote input</li> </ul> 	<p><b>Threshold Condition Not Accepted</b> Displays read "dr SET" then alternate "FAIL" with minimum % Offset<sup>19</sup> for sensing condition; Sensor returns to Adjust mode</p> 

<sup>17</sup> SET Button: 0.04 seconds ≤ "Click" ≤ 0.8 seconds

<sup>18</sup> Remote Input: 0.04 seconds ≤ T ≤ 0.8 seconds

<sup>19</sup> See [Troubleshooting](#) on page 22 for more explanation of the % Offset displayed after the Dark SET method

3. Return to RUN Mode.

Method	Action	Result
SET Button	Move Mode switch to RUN 	Display: Red - Signal Level; Green - Threshold 
Remote Input	No action required; sensor returns to RUN mode automatically	

## Calibration SET

- Sets a threshold exactly at the presented condition
- Threshold can be adjusted using "+" and "-" rocker button (Manual Adjust)

A single sensing condition is presented, and the sensor positions a threshold exactly at the presented condition. When a condition lighter than the threshold is sensed, the output either turns ON or OFF, depending on the LO/DO setting.

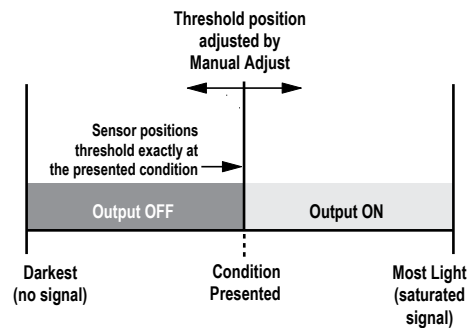

Figure 14. Calibration SET (Light Operate shown)

### Calibration SET and Manual Adjust

Moves switching threshold value up or down to make adjustments

- Slide Mode switch to ADJ to enter Adjust mode
- Press "+" to increase; press "-" to decrease
  - GREEN display shows the switching threshold value
  - 2 seconds after adjustment, the GREEN display will flash 3 times to confirm
- Slide Mode switch to RUN to complete operation





**Remember:** Auto Thresholding is automatically disabled in Calibration SET

Follow these steps to perform a Calibration SET:



**Note:** TEACH Selection must be programmed to **CAL SET**.



1. Enter Adjust Mode

Method	Action	Result
SET Button <sup>20</sup>	• Set Mode switch to ADJ 	Display: Red - Signal Level; Green - Threshold 
Remote Input <sup>21</sup>	No action required; sensor is ready for Calibration SET method	

2. SET Sensing Condition

<sup>20</sup> SET Button: 0.04 seconds ≤ "Click" ≤ 0.8 seconds

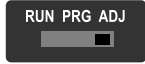
<sup>21</sup> Remote Input: 0.04 seconds ≤ T ≤ 0.8 seconds

Method	Action	Result
SET Button	<ul style="list-style-type: none"> <li>Present sensing condition</li> <li>Click the SET rocker button</li> </ul> 	<p><b>Threshold Condition Accepted</b> Displays read "cAL SET" then flashes "PASS"; Sensor returns to Adjust mode</p>
Remote Input	<ul style="list-style-type: none"> <li>Present sensing condition</li> <li>Single-pulse the remote input</li> </ul> 	<p><b>Threshold Condition Unacceptable</b> Displays read "cAL SET" then flashes "FAIL"; Sensor returns to Adjust mode</p>

3. Return to RUN Mode

Method	Action	Result
SET Button	Move Mode switch to RUN	 Display: Red - Signal Level; Green - Threshold 
Remote Input	No action required; sensor returns to RUN mode automatically	

### 3.5.2 Troubleshooting

#### Manual Adjustments Disabled

Manual adjustments are disabled when Auto Thresholds are ON. If a manual adjustment is attempted while Auto Thresholds are ON, the Green display will flash .

#### Percent Minimum Difference after TEACH

The Two-Point and Dynamic TEACH methods will flash a % minimum difference on the displays after a PASS or FAIL.

Value	PASS/FAIL	Description
0 to 99%	FAIL	The difference of the taught conditions does not meet the required minimum
100 to 300%	PASS	The difference of the taught conditions just meets/exceeds the required minimum, minor sensing variables may affect sensing reliability
300 to 600%	PASS	The difference of the taught conditions sufficiently exceeds the required minimum, minor sensing variables will not affect sensing reliability
600% +	PASS	The difference of the taught conditions greatly exceeds the required minimum, very stable operation



#### Percent Offset after SET

The Window, Dark, and Light SET methods will flash a % offset on the displays after a PASS or FAIL.

SET Result	% Offset Meaning
PASS (with % Offset)	Displays the % offset used for the SET method
FAIL (with % Offset)	Displays the minimum required % offset necessary to PASS the SET method
FAIL (without % Offset)	Presented condition cannot be used for the SET method

## Threshold Alert or Threshold Error

Severe contamination/changes in the taught condition can prevent the Auto Thresholds algorithm from optimizing the threshold(s).

State	Display	Description	Corrective Action
Threshold Alert	Alternates  and 	The threshold(s) cannot be optimized, but the sensor's output will still continue to function	Cleaning/correcting the sensing environment and/or a re-teach of the sensor is highly recommended
Threshold Error		The threshold(s) cannot be optimized, and the sensor's output will stop functioning	Cleaning/correcting the sensing environment and/or a re-teach of the sensor is required

## 4 IO-Link Interface

IO-Link is a point-to-point communication link between a master device and sensor. Use IO-Link to parameterize sensors and transmit process data automatically.

For the latest IO-Link protocol and specifications, see [www.io-link.com](http://www.io-link.com).

Each IO-Link device has an IODD (IO Device Description) file that contains information about the manufacturer, article number, functionality etc. This information can be easily read and processed by the user. Each device can be unambiguously identified via the IODD as well as via an internal device ID. Download the DF-G3 Long Range Expert with IO Link's IO-Link IODD package (p/n 18491) from Banner Engineering's website at [www.bannerengineering.com](http://www.bannerengineering.com).

Banner has also developed Add On Instruction (AOI) files to simplify ease-of-use between the DF-G3 Long Range Expert with IO Link, multiple third-party vendors' IO-Link masters, and the Logix Designer software package for Rockwell Automation PLCs. Three types of AOI files for Rockwell Allen-Bradley PLCs are listed below. These files and more information can be found at [www.bannerengineering.com](http://www.bannerengineering.com).

**Process Data AOIs**—These files can be used alone, without the need for any other IO-Link AOIs. The job of a Process Data AOI is to intelligently parse out the Process Data word(s) in separate pieces of information. All that is required to make use of this AOI is an EtherNet/IP connection to the IO-Link Master and knowledge of where the Process Data registers are located for each port.

**Parameter Data AOIs**—These files require the use of an associated IO-Link Master AOI. The job of a Parameter Data AOI, when working in conjunction with the IO-Link Master AOI, is to provide quasi-realtime read/write access to all IO-Link parameter data in the sensor. Each Parameter Data AOI is specific to a given sensor or device.

**IO-Link Master AOIs**—These files require the use of one or more associated Parameter Data AOIs. The job of an IO-Link Master AOI is to translate the desired IO-Link read/write requests, made by the Parameter Data AOI, into the format a specific IO-Link Master requires. Each IO-Link Master AOI is customized for a given brand of IO-Link Master.

Add and configure the relevant Banner IO-Link Master AOI in your ladder logic program first; then add and configure Banner IO-Link Device AOIs as desired, linking them to the Master AOI as shown in the relevant AOI documentation.



# 5 Specifications

## Sensing Beam

DF-G3: Visible red, 635 nm  
DF-G3IR: Infrared, 850 nm

## Supply Voltage

10 V to 30 V dc Class 2 (10% maximum ripple)

## Power and Current Consumption (exclusive of load)

**Standard display mode:** 960 mW, Current consumption < 40 mA at 24 V dc

**ECO display mode:** 720 mW, Current consumption < 30 mA at 24 V dc

## Supply Protection Circuitry

Protected against reverse polarity and transient overvoltages

## Delay at Power-Up

500 milliseconds maximum; outputs do not conduct during this time

## Output Configuration

CH1 = IO-Link, Push/pull  
CH2 = PNP only output or input

## Output Rating

100 mA maximum load each output (derate 1 mA per °C above 30° C)

100 mA max total load current for sensor

**OFF-state leakage current:** < 5 µA PNP at 30 V dc (N.A. push/pull);

**ON-state saturation voltage:** < 2 V

## Required Overcurrent Protection



**WARNING:** Electrical connections must be made by qualified personnel in accordance with local and national electrical codes and regulations.

Overcurrent protection is required to be provided by end product application per the supplied table.

Overcurrent protection may be provided with external fusing or via Current Limiting, Class 2 Power Supply.

Supply wiring leads < 24 AWG shall not be spliced.

For additional product support, go to [www.bannerengineering.com](http://www.bannerengineering.com).

Supply Wiring (AWG)	Required Overcurrent Protection (Amps)
20	5.0
22	3.0
24	2.0
26	1.0
28	0.8
30	0.5

## IO-Link Interface

**Supports smart sensor profile:** Yes

**Baud rate:** 38400 bps

**Process data widths:** 16 bits

**IODD files:** Provides all programming options of the display, plus additional functionality

## Output Protection

Protected against output short-circuit, continuous overload, transient overvoltages, and false pulse on power-up

## Construction

Black ABS/polycarbonate alloy (UL94 V-0 rated) housing, clear polycarbonate cover

## Connections

PVC jacketed 2 m (6.5 ft) 4-wire integral cable; or integral 4-pin M8/Pico-style quick disconnect; or 150 mm (6 inch) cable with a 4-pin M12/Euro-style quick disconnect; or 150 mm (6 inch) cable with a 4-pin M8/Pico-style quick disconnect

## Adjustments

3-way RUN/PRG/ADJ Mode Switch

2-way CH1/CH2 Switch

3-way +/-SET/- Rocker Button

- Expert-style teaching (Two-Point and Dynamic TEACH, Light/Dark/Window/Calibration SET)
- Manually adjust sensitivity (from "+" and "-" rocker button only)
- Response Speed, TEACH Selection, Offset Percent, Auto Thresholds, Delays/Timers, Display Readout, Gain Selection, Factory Defaults (from top panel or remote input)
- Top panel interface lockout (from remote input only)

## Indicators

**Red 4-digit Display:** Signal Level

**Green 4-digit Display:** Threshold

(In Program Mode, Red and Green displays are used for programming menus)

**Amber LED:** Output conducting

## Environmental Rating

IEC IP50, NEMA 1

## Operating Conditions

**Temperature:** -10 °C to +55 °C (+14 °F to +131 °F)

**Storage Temperature:** -20 °C to +85 °C (-4 °F to +185 °F)

**Humidity:** 90% at +60 °C maximum relative humidity (non-condensing)

## Certifications

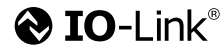

## Response Speed

Description	Response Speed	Repetition Period	Repeatability	Cross-Talk Avoidance	Energy Efficient Light Resistance	Maximum Range, Red <sup>22</sup>	Maximum Range, IR850 <sup>23</sup>
High Speed	500 µs	100 µs	100 µs	No	No	1200 mm	2400 mm
Fast	1000 µs	100 µs	150 µs	Yes	No	1500 mm	3000 mm
Standard	2 ms	100 µs	180 µs	Yes	Yes	1500 mm	3000 mm
Long Range	8 ms	100 µs	180 µs	Yes	Yes	1950 mm	3900 mm
Extra Long Range	24 ms	100 µs	180 µs	Yes	Yes	3000 mm	6000 mm

<sup>22</sup> Excess gain = 1 (high sensitivity), opposed mode sensing. PIT46U plastic fiber used for visible LED models.

<sup>23</sup> Excess gain = 1 (high sensitivity), opposed mode sensing. IT.83.3ST5M6 glass fiber used for IR models.

## 5.1 Excess Gain Curves

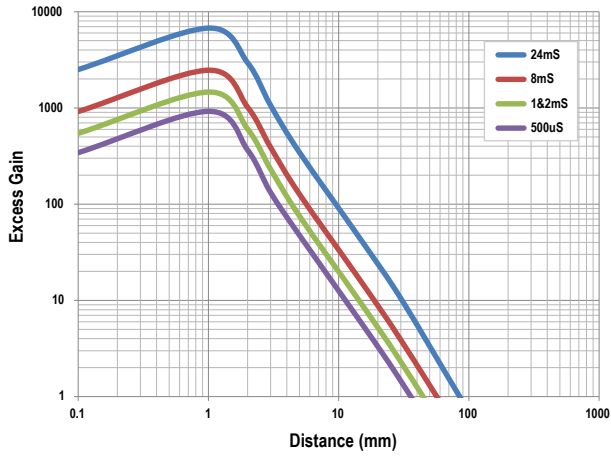

Figure 15. Diffuse-PBT16U

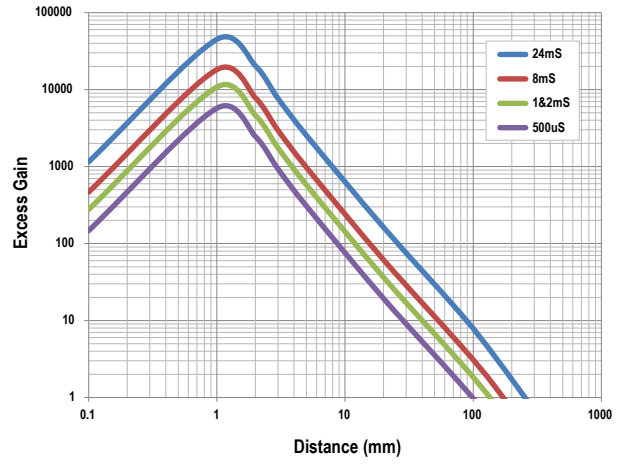

Figure 16. Diffuse-PBT26U

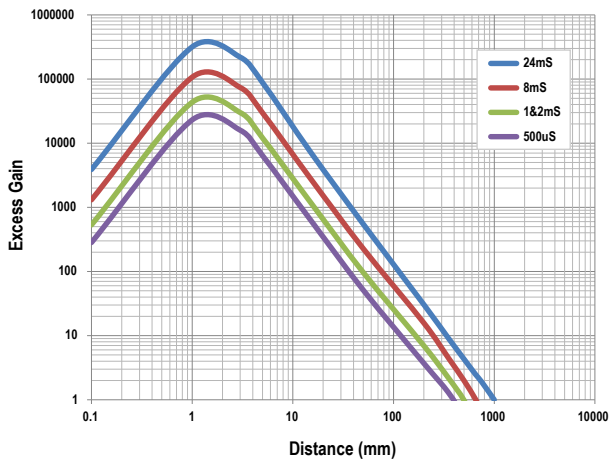

Figure 17. Diffuse-PBT46U

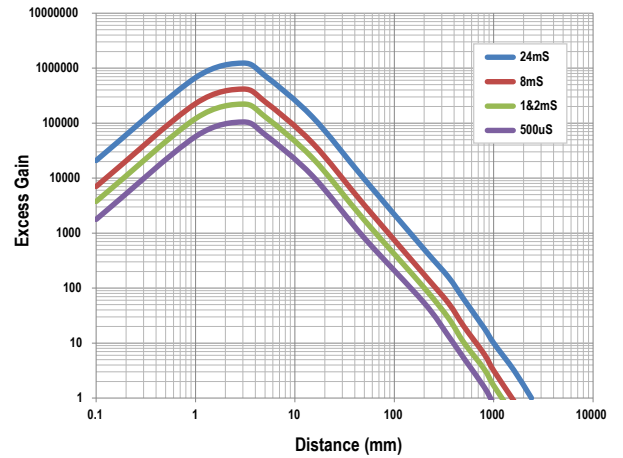

Figure 18. Diffuse-PBT66U

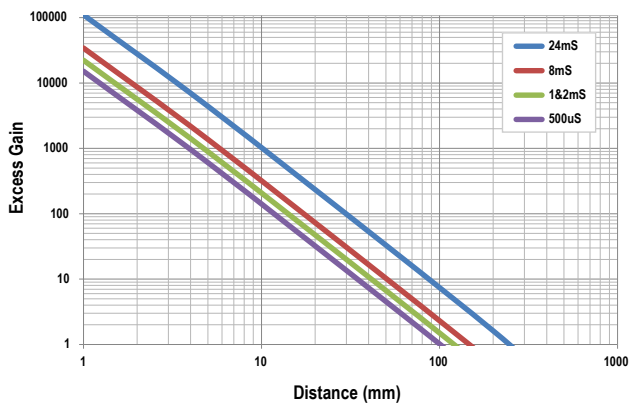

Figure 19. Opposed Mode-PIT16U

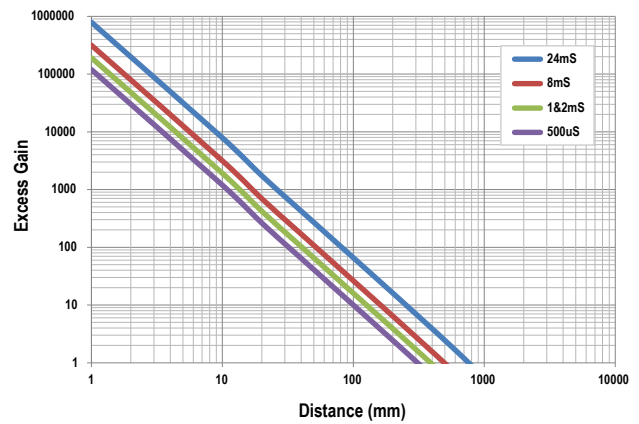

Figure 20. Opposed Mode-PIT26U

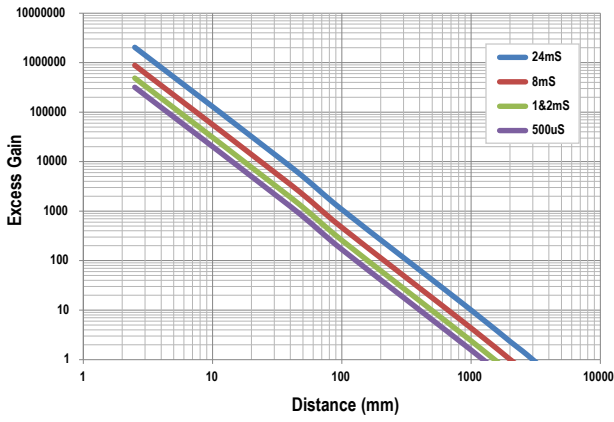
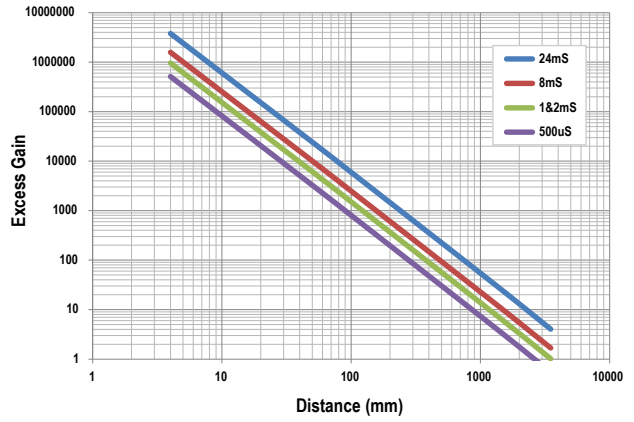
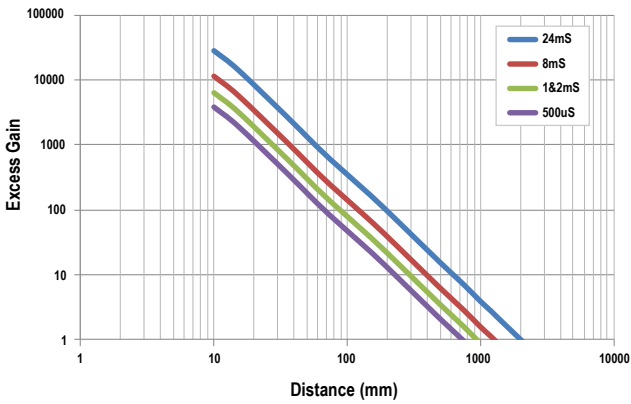

Figure 21. Opposed Mode—PIT46U



**Note:** The length of the fiber optics limits the range for the 8 and 24 ms response speeds.

Figure 22. Opposed Mode—PIT66U



**Note:** BTC1.13.4ST5M6 glass fiber used for diffuse mode

Figure 23. Diffuse—IR850

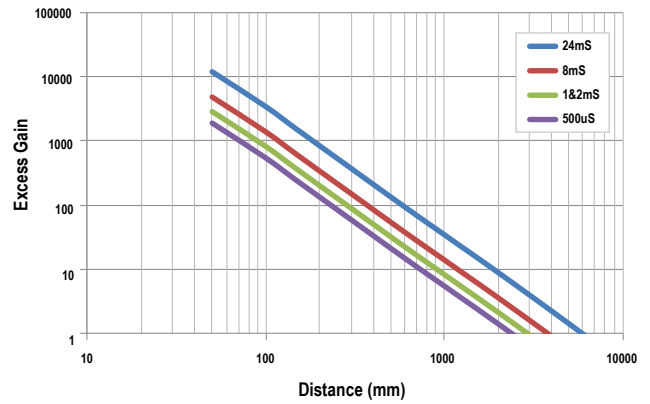

**Note:** IT.83.3ST5M6 glass fiber used for opposed mode

Figure 24. Opposed Mode—IR850

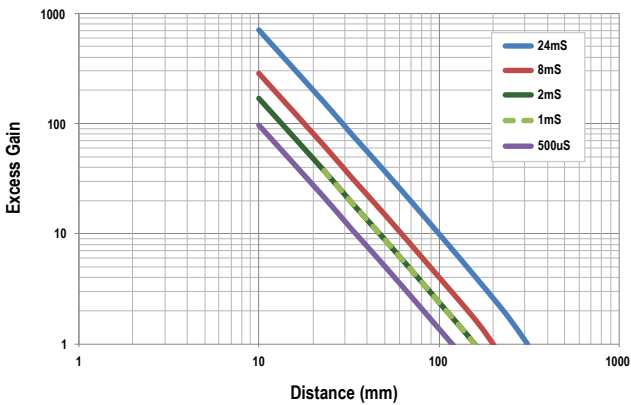

Figure 25. Diffuse—LIR1450

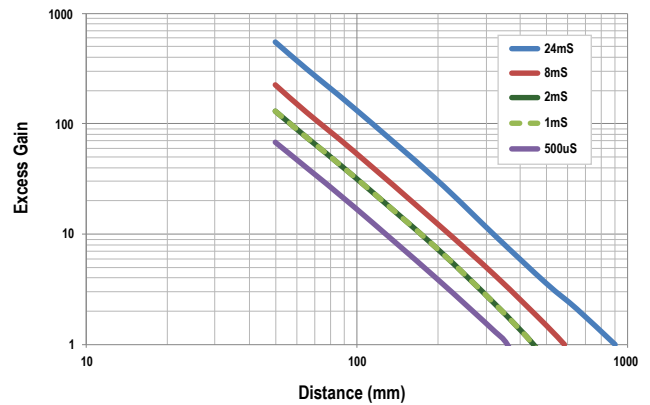

Figure 26. Opposed Mode—LIR1450

## 5.2 Beam Patterns

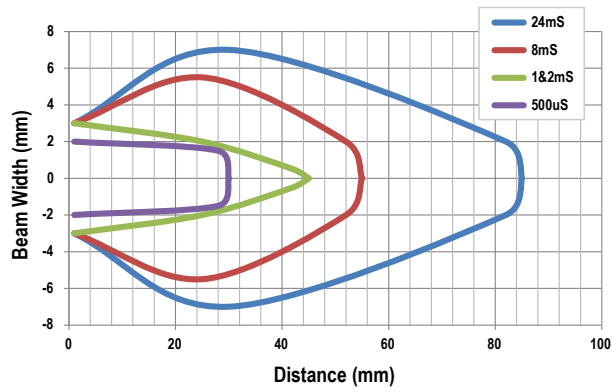

Figure 27. Diffuse—PBT16U

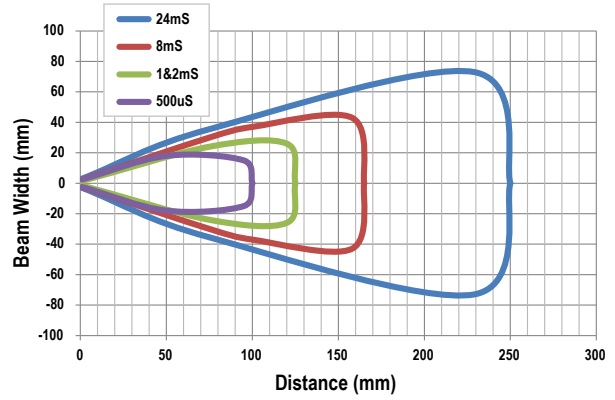

Figure 28. Diffuse—PBT26U

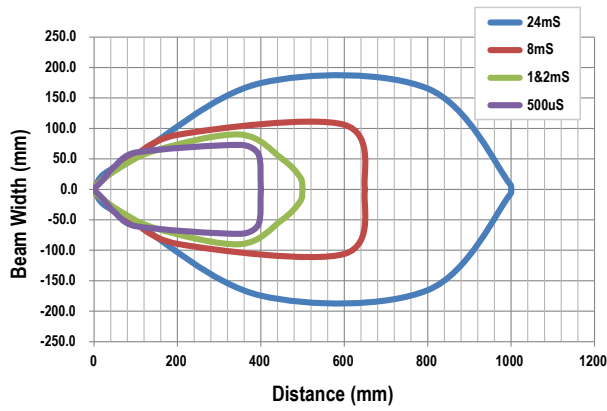

Figure 29. Diffuse—PBT46U

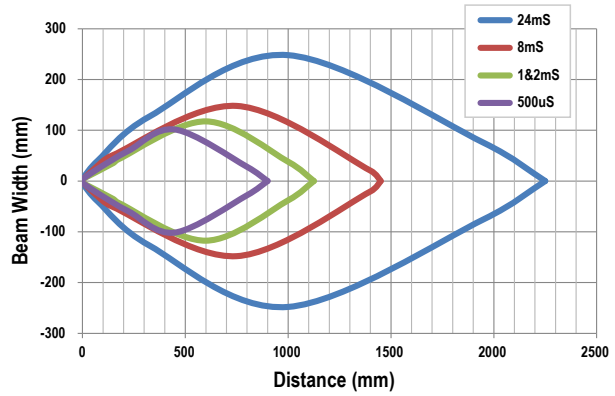

Figure 30. Diffuse—PBT66U

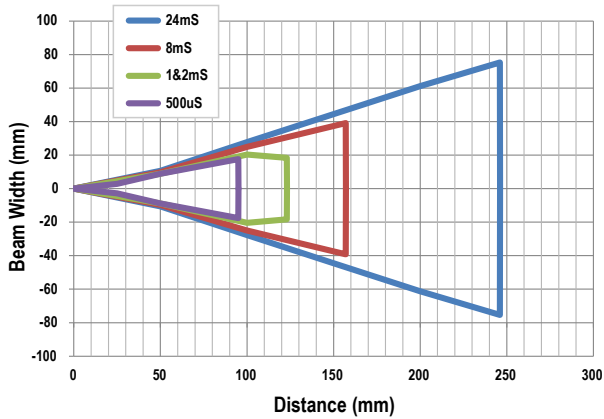

Figure 31. Opposed Mode—PIT16U

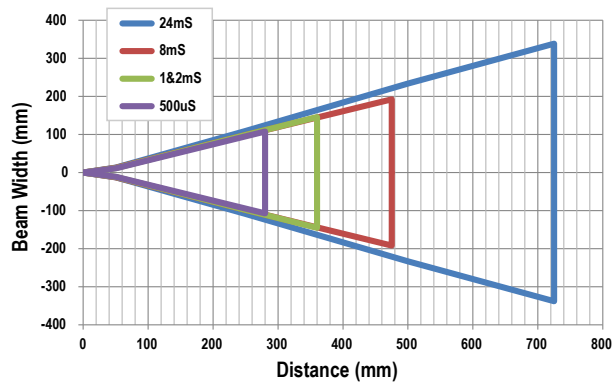

Figure 32. Opposed Mode—PIT26U

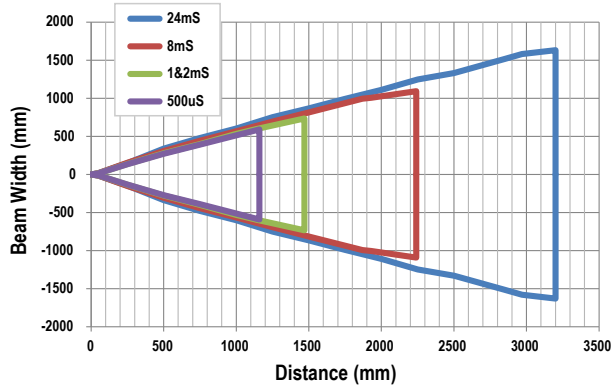

Figure 33. Opposed Mode—PIT46U

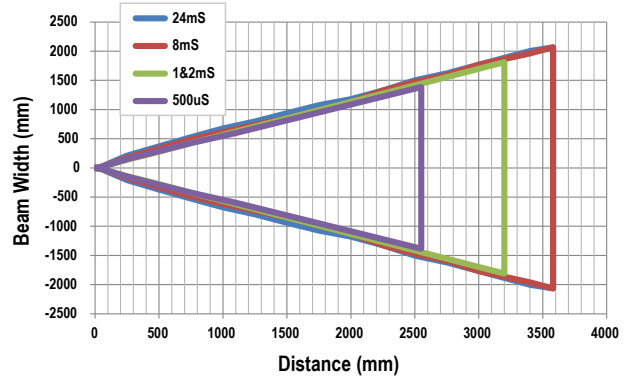

Figure 34. Opposed Mode—PIT66U

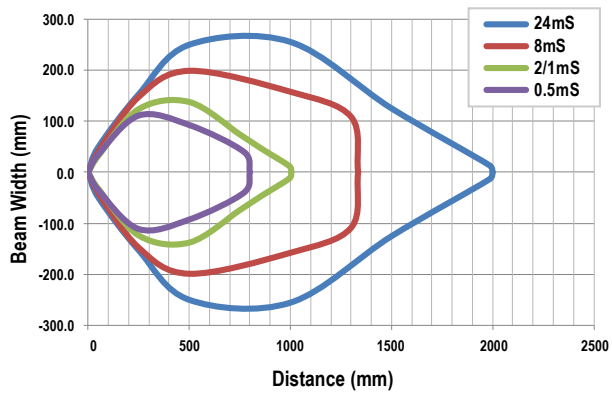

Figure 35. Diffuse—IR850

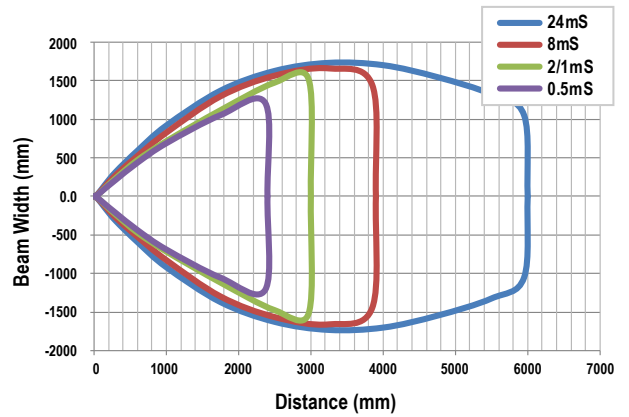



Figure 36. Opposed Mode—IR850

 **Note:** BTC1.13.4ST5M6 glass fiber used for diffuse mode

 **Note:** IT.83.3ST5M6 glass fiber used for opposed mode

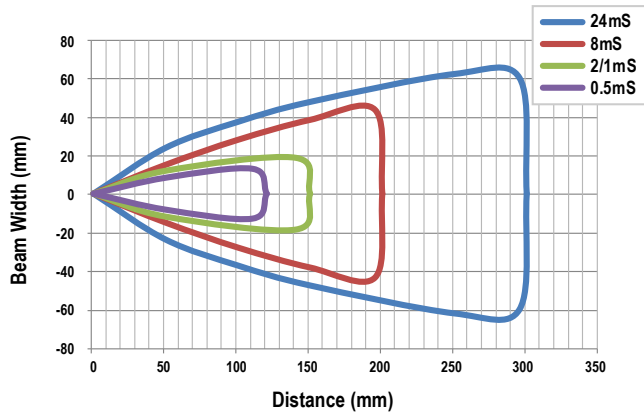

Figure 37. Diffuse—LIR1450

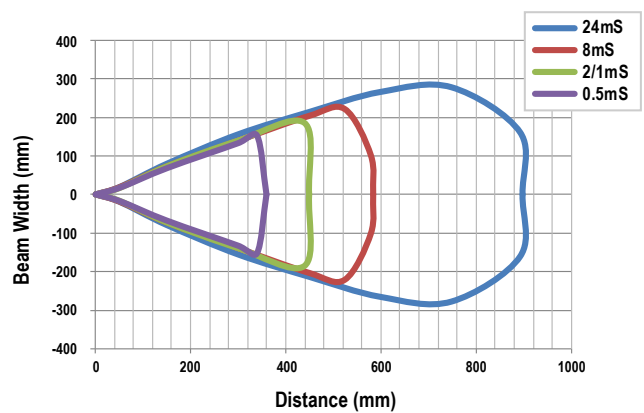
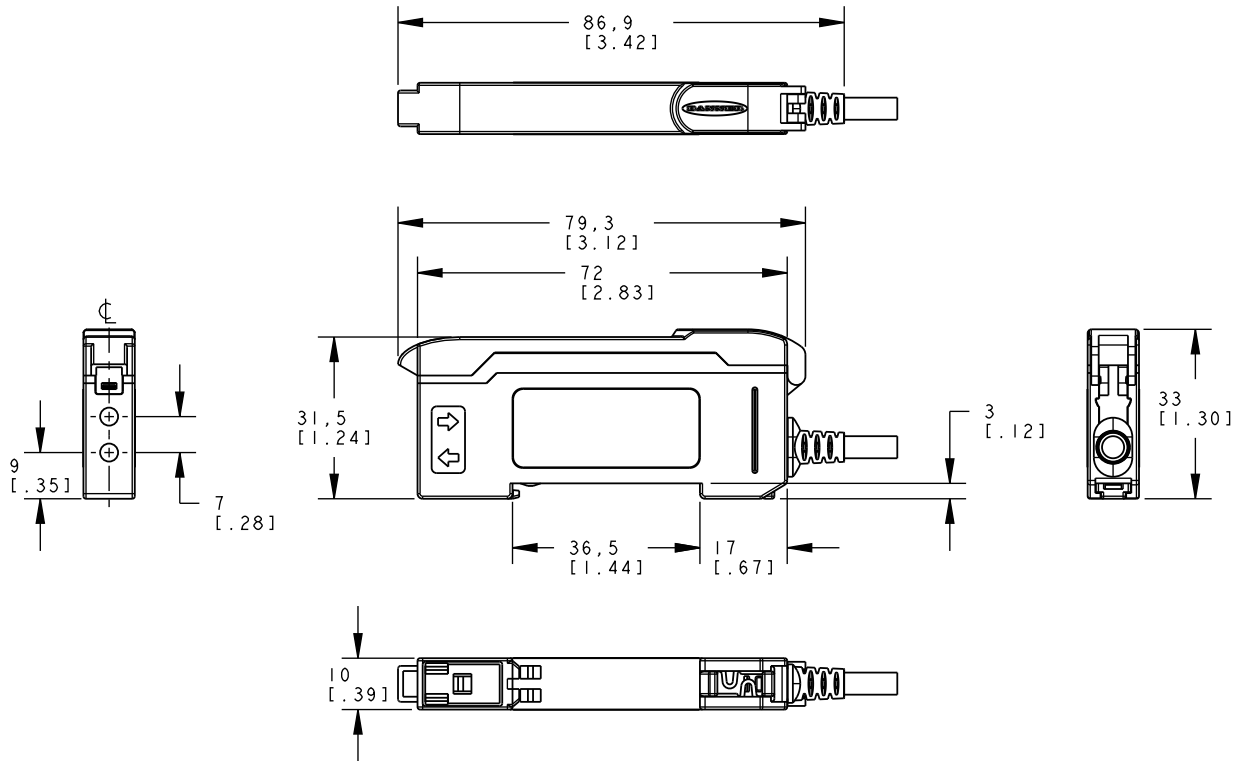

Figure 38. Opposed Mode—LIR1450

## 5.3 Dimensions



# 6 Accessories

## DIN-35-..

35 mm DIN Rail

Model	Length
DIN-35-70	70
DIN-35-105	105
DIN-35-140	140

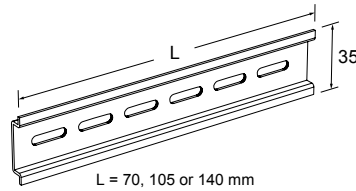

Hole center spacing: 35.1

Hole size: 25.4 x 5.3

## SA-DIN-CLAMP

- Pair of metal DIN rail end stops; slide onto DIN rail at either side of the sensor stack
- Combination (#2 Phillips, #8 standard slotted) set screw

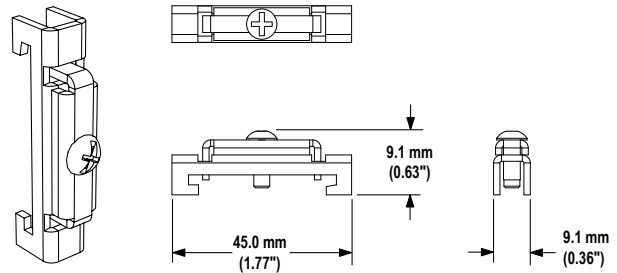

## SA-DIN-BRACKET

- Plastic bracket with mounting screws

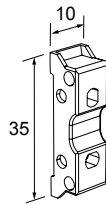

Hole center spacing: A = 16, B = 25.4, C = 15.2

Hole size: A =  $\varnothing$  3.2, B =  $\varnothing$  3.3, C =  $\varnothing$  4.4

## SA-DIN-BRACKET-10

- Package of 10 plastic brackets with mounting screws

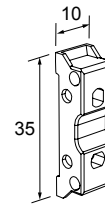



Hole center spacing: A = 16, B = 25.4, C = 15.2



Hole size: A =  $\varnothing$  3.2, B =  $\varnothing$  3.3, C =  $\varnothing$  4.4

# 6.1 Quick-Disconnect Cordsets—Single Output Models

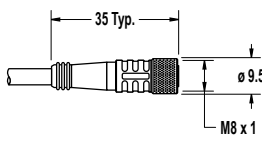
All measurements are listed in millimeters, unless noted otherwise.

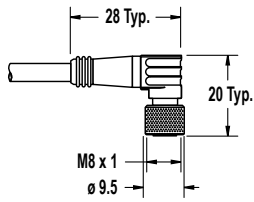
4-Pin Threaded M12/Euro-Style Cordsets—Single Ended				
Model	Length	Style	Dimensions	Pinout (Female)
MQDC-406	1.83 m (6 ft)	Straight		<p>1 = Brown 2 = White 3 = Blue 4 = Black</p>
MQDC-415	4.57 m (15 ft)			
MQDC-430	9.14 m (30 ft)			
MQDC-450	15.2 m (50 ft)	Right-Angle		
MQDC-406RA	1.83 m (6 ft)			
MQDC-415RA	4.57 m (15 ft)			
MQDC-430RA	9.14 m (30 ft)			
MQDC-450RA	15.2 m (50 ft)			

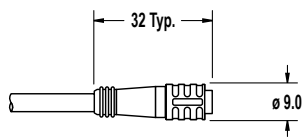
4-Pin Threaded M8/Pico-Style Cordsets—Single Ended				
Model	Length	Style	Dimensions	Pinout (Female)
PKG4M-2	2 m (6.56 ft)	Straight		 <p>1 = Brown 2 = White 3 = Blue 4 = Black</p>
PKG4M-5	5 m (16.4 ft)			
PKG4M-9	9 m (29.5 ft)			
PKW4M-2	2 m (6.56 ft)	Right Angle		
PKW4M-5	5 m (16.4 ft)			
PKW4M-9	9 m (29.5 ft)			

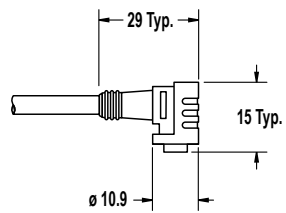
4-Pin Snap-on M8/Pico-Style Cordsets—Single Ended				
Model	Length	Style	Dimensions	Pinout (Female)
PKG4-2	2 m (6.6 ft)	Straight		 <p>1 = Brown 2 = White 3 = Blue 4 = Black</p>
PKG4-5	5 m (16.4 ft)			
PKG4-10	10 m (32.8 ft)			
PKW4Z-2	2 m (6.6 ft)	Right-Angle		
PKW4Z-5	5 m (16.4 ft)			



# 7 Banner Engineering Corp. Limited Warranty

Banner Engineering Corp. warrants its products to be free from defects in material and workmanship for one year following the date of shipment. Banner Engineering Corp. will repair or replace, free of charge, any product of its manufacture which, at the time it is returned to the factory, is found to have been defective during the warranty period. This warranty does not cover damage or liability for misuse, abuse, or the improper application or installation of the Banner product.

**THIS LIMITED WARRANTY IS EXCLUSIVE AND IN LIEU OF ALL OTHER WARRANTIES WHETHER EXPRESS OR IMPLIED (INCLUDING, WITHOUT LIMITATION, ANY WARRANTY OF MERCHANTABILITY OR FITNESS FOR A PARTICULAR PURPOSE), AND WHETHER ARISING UNDER COURSE OF PERFORMANCE, COURSE OF DEALING OR TRADE USAGE.**

This Warranty is exclusive and limited to repair or, at the discretion of Banner Engineering Corp., replacement. **IN NO EVENT SHALL BANNER ENGINEERING CORP. BE LIABLE TO BUYER OR ANY OTHER PERSON OR ENTITY FOR ANY EXTRA COSTS, EXPENSES, LOSSES, LOSS OF PROFITS, OR ANY INCIDENTAL, CONSEQUENTIAL OR SPECIAL DAMAGES RESULTING FROM ANY PRODUCT DEFECT OR FROM THE USE OR INABILITY TO USE THE PRODUCT, WHETHER ARISING IN CONTRACT OR WARRANTY, STATUTE, TORT, STRICT LIABILITY, NEGLIGENCE, OR OTHERWISE.**

Banner Engineering Corp. reserves the right to change, modify or improve the design of the product without assuming any obligations or liabilities relating to any product previously manufactured by Banner Engineering Corp. Any misuse, abuse, or improper application or installation of this product or use of the product for personal protection applications when the product is identified as not intended for such purposes will void the product warranty. Any modifications to this product without prior express approval by Banner Engineering Corp will void the product warranties. All specifications published in this document are subject to change; Banner reserves the right to modify product specifications or update documentation at any time. Specifications and product information in English supersede that which is provided in any other language. For the most recent version of any documentation, refer to: [www.bannerengineering.com](http://www.bannerengineering.com).

For patent information, see [www.bannerengineering.com/patents](http://www.bannerengineering.com/patents).