

# Automotive Industry Solutions

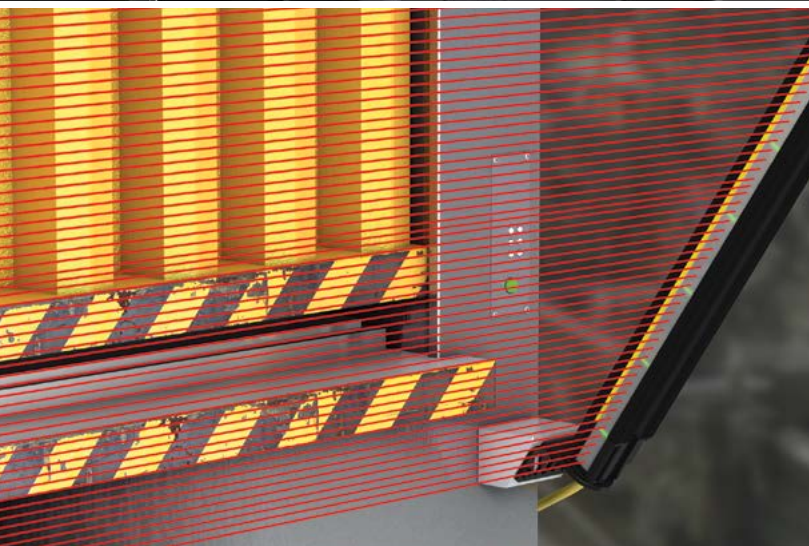

# Intelligent Solutions for Complex Processes

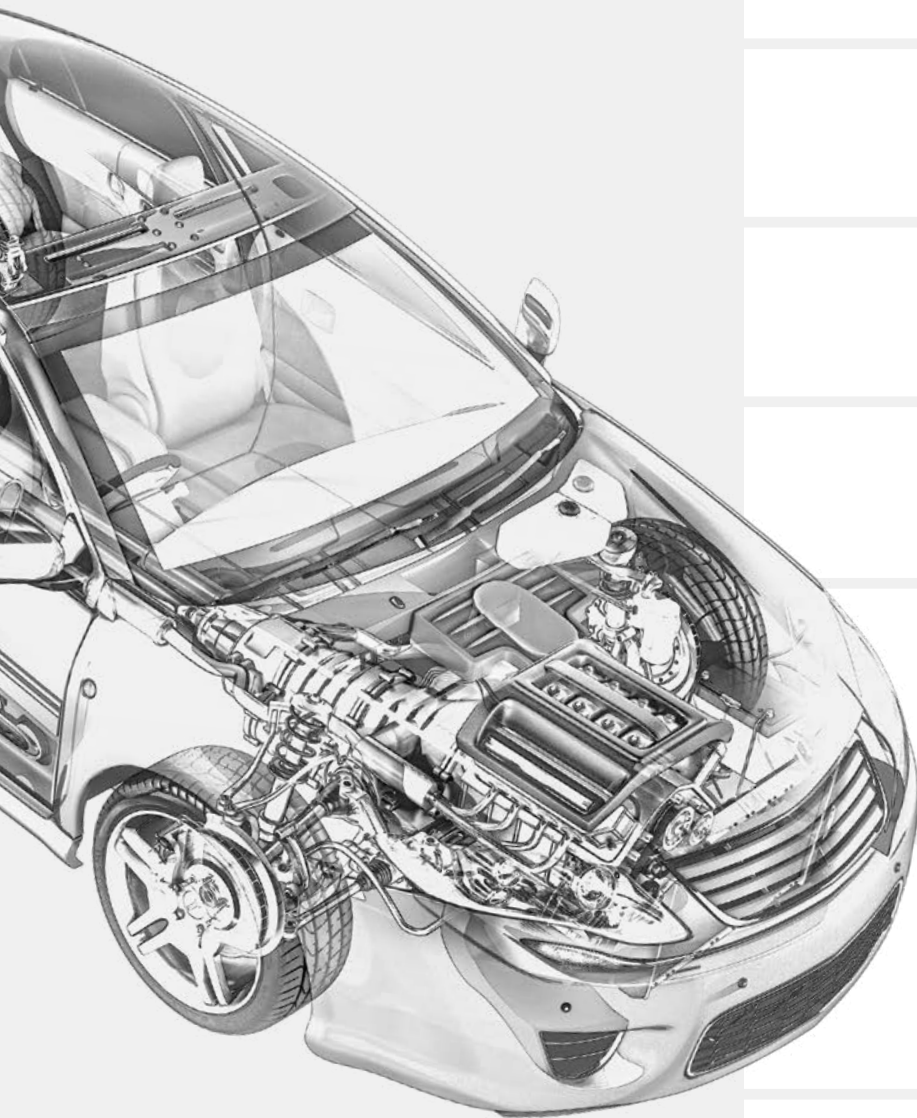

## Facility Management/Energy Saving

- Energy savings
- Cost savings
- Increase efficiency

## Tier Automotive

- Improve production processes
- Reduce downtime
- Verify product quality

## Press Shop

- Material handling
- Stamping and metal fabrication
- Sub-assembly

## Body Shop

- Automated welding
- Application of adhesives, beads, and sealants
- Robot-intensive assembly

## Paint Shop

- Cleaning of finished body
- Sealing and adding primer
- Painting and top coating
- Cure and drying
- Material handling and robotics

## Powertrain

- Casting of engines and transmissions
- Machining
- Heat treatment
- Assembly and test
- Material handling

## EV Battery Production

- Producing lithium batteries
- Electric motors
- Charging systems
- Machine safeguarding

## General Assembly

- Chassis assembly
- Trim, fit, and finish
- Final assembly

## Table of Contents

Facility Management/Energy Saving .....	4
Tier Automotive .....	6
Press Shop .....	8
Body Shop .....	10
Paint Shop .....	12
Powertrain.....	14
EV Battery Production .....	16
General Assembly.....	18

## Product Solutions

Sensors.....	21
Lighting and Indication .....	24
Machine Safety .....	28
Industrial Wireless.....	30
Barcode and Vision .....	33
Connectivity Technology .....	33
Snap Signal Overview .....	34



# Facility Management/Energy Saving

Facility management entails a wide variety of responsibilities to keep the production floor humming. Energy management, logistics, and environmental control to name a few. Banner offers simple and effective solutions for the diverse needs of facilities.

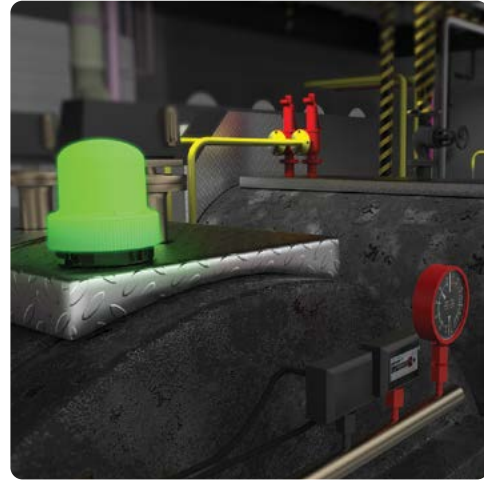

## Indicating Operational Status of Boiler Room

### Challenge

The boiler room can experience malfunctions that cause costly downtime, especially when there is no clear indication of potential problems prior to failure.

### Solution

- K100 Pro Indicator beacons were used to communicate the operational status of each individual boiler.
- Workers were able to program the K100s to appear magenta when maintenance would be needed soon and red when the boiler was powered down or when a critical error was detected.



**K100 Pro Beacons**  
(p. 25)



## Energy Consumption in Panel

### Challenge

A method is needed to monitor energy usage for consumption reduction efforts and OEE tracking. Because production machinery control panels contain the switch gear to power devices on the factory floor, they offer a suitable location for current monitoring.

### Solution

- Adding a Banner in-line current sensor and an S15C IO-Link converter makes it possible to monitor current draw in real time with connection to a DXM IO-Link master controller.
- Current monitoring helps identify any devices that waste energy by running when not needed and can track equipment uptime. Identifying such problems can lead to significant monetary savings.



**DXMR90 Industrial Controllers**  
(p. 30)



**S15C In-Line Converters with Current Transformer**  
(p. 33)

Learn more about Snap Signal on page 34



## Backing a Truck into a Loading Dock

### Challenge

Even for experienced drivers, visually estimating the distance to a loading dock while backing up a truck or semi-trailer can prove to be difficult. Weather conditions can often make this process even more challenging, particularly if precipitation obscures the truck's sideview mirrors.

### Solution

- Real-time radar measurements of the truck's proximity can be received, and this data can be displayed to drivers using a bright visual indicator.
- Radar sensors are used to reliably detect objects even in challenging outdoor conditions.
- Truck drivers can safely and smoothly back up and park their vehicle at the perfect distance from the dock, enabling highly efficient loading or unloading.



**T30R Radar Sensors**  
(p. 23)



**WLS27 Pro LED Strip Lights**  
(p. 24)

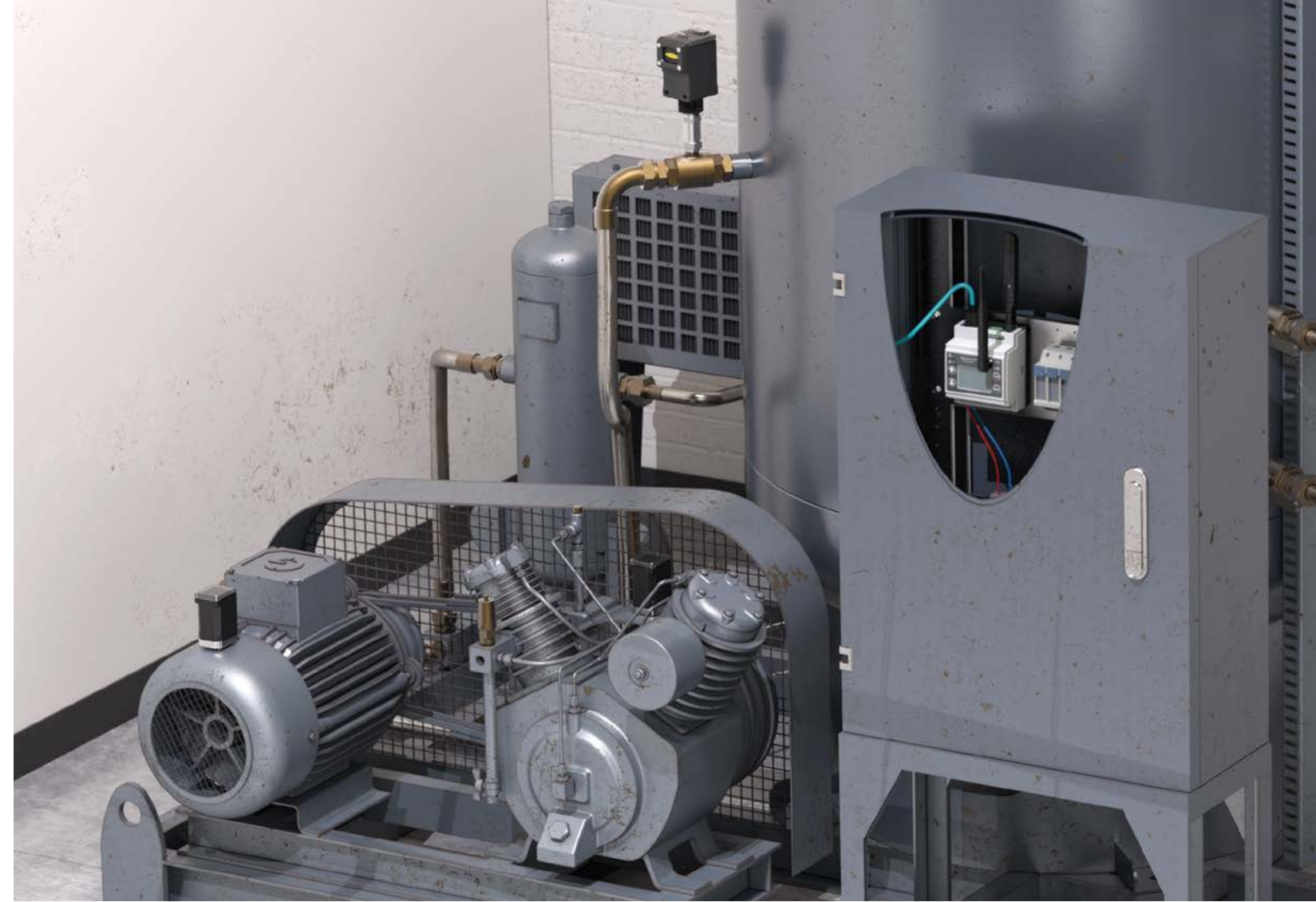

## Air Compressor Monitoring

### Challenge

The loss of compressed air due to a motor or pump failure can disrupt production, resulting in lost revenue, measured in thousands of dollars per minute for critical operations.

### Solution

- The wireless Q45 Vibration and Temperature sensors and DXM Controller allow a move to predictive maintenance by continuously monitoring rotating assets, baselining performance, and sending alerts when the vibration or temperature rises above acceptable thresholds.
- One DXM Controller can monitor many vibration, temperature, or pressure sensors on multiple compressors. The critical data from all sensors is aggregated by the controller and pushed to Banner Cloud Data Services, the resident SCADA, or PLC system.



**DXM700 Industrial Wireless Controllers**  
(p. 30)



**Q45 All-in-One Series Integrated Vibration and Temperature Sensors**  
(p. 31)



**Q45PS All-in-One Pressure Sensors**  
(p. 31)





# Tier Automotive

Working in close partnership with Tier Automotive components suppliers around the world, Banner Engineering offers automation products that help improve production processes, implement lean strategies, reduce downtime, and verify product quality.



## Automotive Seat Inspection

### Challenge

In automotive quality inspections, verifying the presence and position of dark parts against an equally dark background is extremely common. For example, many car seats consist of black fabric or leather material with black plastic components, such as levers and buttons to adjust seat height and tilt.

### Solution

- The Q5X problem-solving triangulation-based laser sensor has no difficulty detecting dark targets on dark backgrounds when there is a height difference.
- Having measurement capabilities down to 1 mm resolution, the Q5X sensor is suitable for many position-critical applications such as seat range-of-motion testing.



**Q5X Photoelectric Sensors**  
(p. 21)



## High-Quality LED Lighting

### Challenge

Finding a high-intensity, ultra-bright lighting solution for manufacturing can be challenging. Since multiple lights are required to properly illuminate areas on a conveyor, a simple mounting option to connect lights together is needed.

### Solution

- Banner's WLB32 is a LED industrial light bar with easy mounting options, such as snap clips and a choice of magnetic or angle brackets.
- LED lights can easily be cascaded to properly illuminate the manufacturing line. Banner's LED lighting is an ideal replacement for conventional fluorescent lighting.



**WLB32 Industrial LED Light Bars**  
(p. 24)



## Detecting Poor Contrast Applications

### Challenge

Verifying that components are present on automotive door panels is extremely important because if any part is missing, the quality of the final door assembly is adversely affected. It can be difficult for standard sensors to differentiate between presence and absence due to poor contrast.

### Solution

- Banner's Q4X problem-solving laser sensor has no difficulty detecting dark targets on dark backgrounds when there is a height difference.
- The Q4X provides a reliable sensing solution and makes pass/fail judgments based on distance rather than color or reflectivity.



**Q4X Laser Distance Measurement Sensors**  
(p. 21)



## Automotive Call-for-Service Workstation

### Challenge

Ensure efficient delivery of parts to assembly areas to keep production moving smoothly.

### Solution

- Direct Select Wireless Operator Interface (paired with K70 illuminated touch button and DXM controller) efficiently guides the driver so he or she knows where parts need to be replenished next.
- High visibility LED indication and dynamic queue with visual display, at the forklift, of which stations are calling, results in fast, efficient delivery of parts when they're needed, allowing production to operate uninterrupted.



**Direct Select Operator Interfaces**  
(p. 30)



**DXM1200 Industrial Wireless Controllers**  
(p. 30)



**K70 Illuminated Touch Buttons**  
(p. 26)

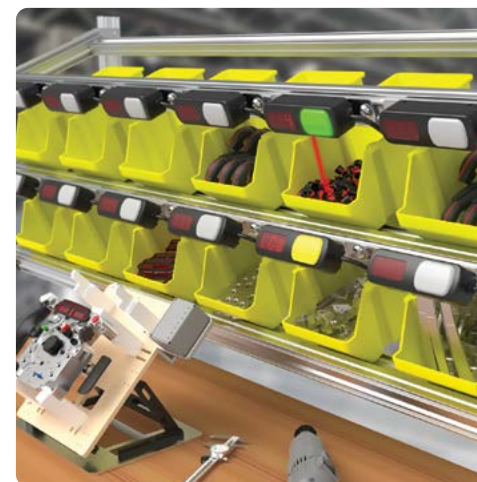

## Multiproduct Light-Guided Assembly Station

### Challenge

Errors can be very common when parts are manually assembled and there is a demand for a variety of different parts. Similar components and hard-to-follow instructions may lead to human error during production, which then slows down the entire process and introduces defects.

### Solution

- The bright and easy-to-see digital displays on the PTL110 devices, combined with an optical sensor that detects hands as they pick pieces, simplifies the build of parts and ensures a high level of quality assurance at multiproduct assembly work stations.
- Minimizing errors during assembly procedures is crucial for companies to keep production levels high and reduce the amount of downtime.



**PTL110 Pick-to-Light Devices**  
(p. 27)



# Press Shop

Banner sensors are used in nearly all areas of the press shop. They ensure stable processes, optimum load, quality inspection, and safeguard operators from injury in this high risk environment.

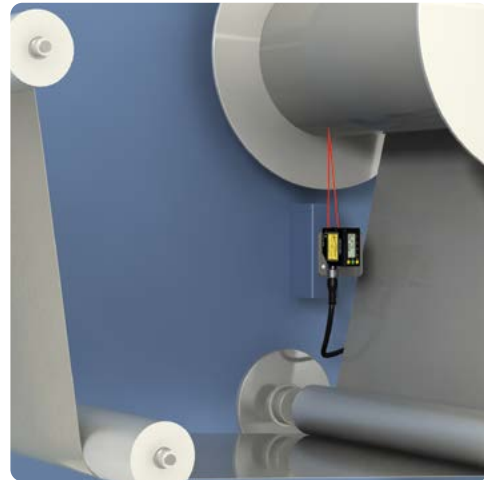

## Metal Roll Diameter and Unwind Speed

### Challenge

During metal stamping, it is important to accurately determine the diameter of a roll of sheet metal to prevent the material from running out.

### Solution

- The LE550 laser measurement sensor accurately measures challenging targets like shiny and reflective surfaces.
- The laser sensor's intuitive user interface makes it easy to adjust settings and set up a roll diameter application, without needing to unwind the roll.



**LE Laser Measurement Sensors**  
(p. 21)

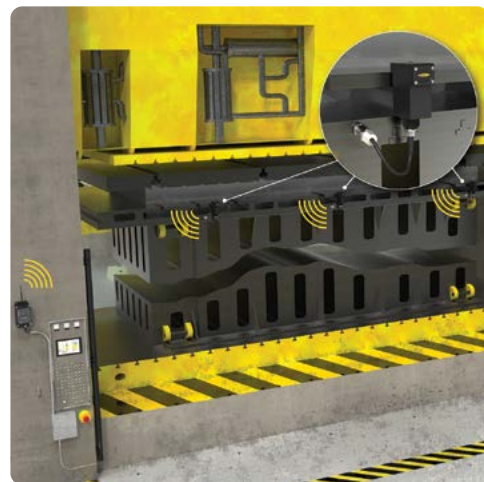

## Monitoring the Nitrogen Cylinder on a Press

### Challenge

Via a consistent wireless signal, monitor nitrogen pressure level on a stamping press to ensure a correct nitrogen level so part quality is consistently maintained.

### Solution

- Pressure Sensors (paired with Q45 Wireless Nodes and DXM Controller) monitors pressure levels and conveys the data via EtherNet communications to the press controls or plant SCADA system.
- The node battery's life span is greater than one year and dependent on sample frequency, ensuring a long time between battery replacement.



**Q45 Nodes and Gauge Pressure Sensor**  
(p. 31)



## Error Proofing

### Challenge

Many stamped metal parts have punch holes to accommodate other parts in the assembly process. Occasionally, the hole-punch does not go all the way through, leading to inconsistencies in the stamped parts.

### Solution

- To verify the number of holes on a small metal part, the iVu Plus TG Image Sensor with Multipoint Inspections can be configured for multiple regions of interest (ROIs).
- Inspection ensures holes exist and were punched in the correct place. If not, the sensor sends a fail output so the part is rejected.



**iVu Vision Sensors**  
(p. 33)

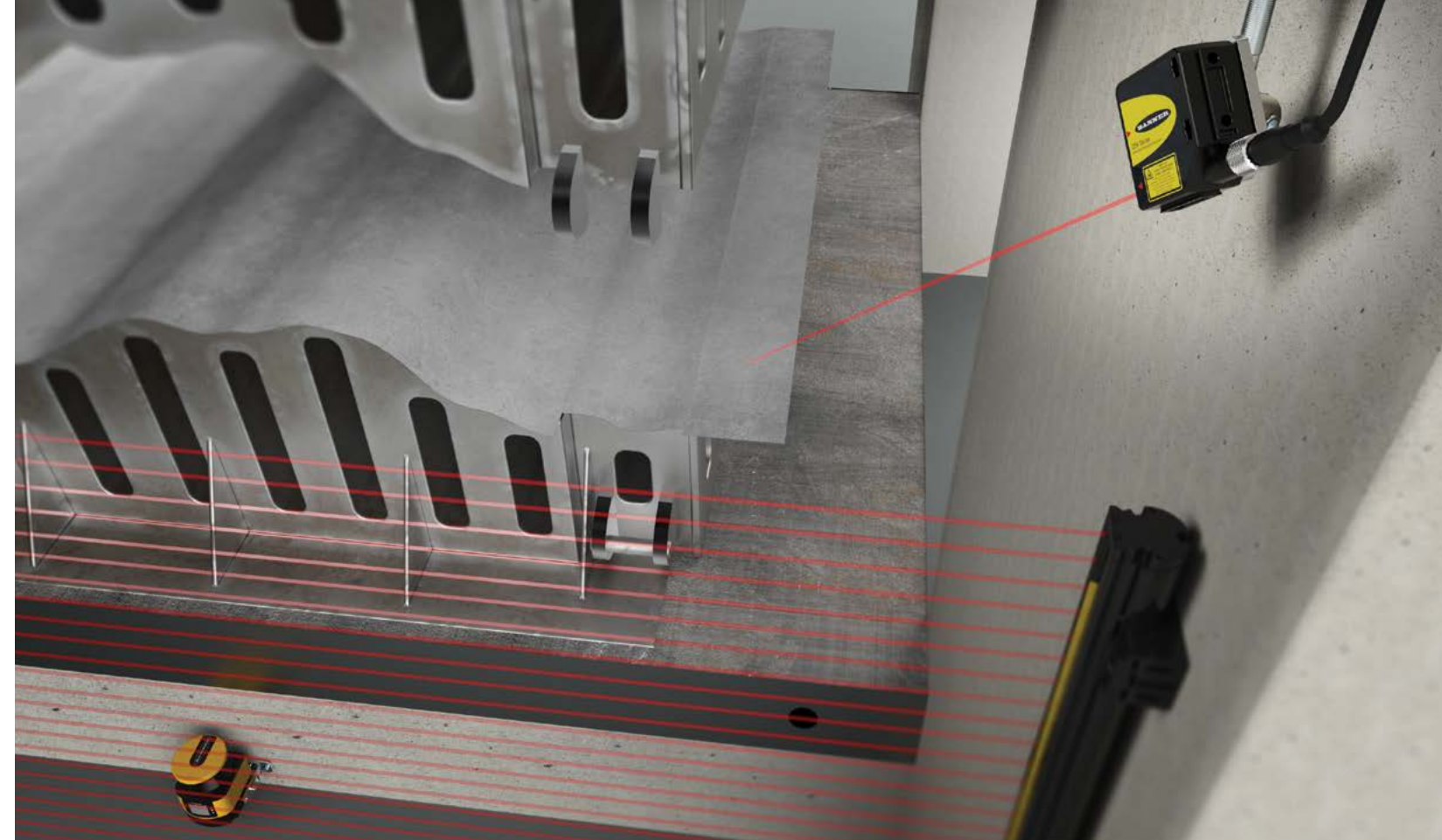

## Metal Stamping

### Challenge

The press shop is known to be one of the more hostile production environments for equipment and people in an automotive manufacturing plant. Both personnel and tooling must be protected from hazards related to press operation and material feed.

### Solution

- Q5X laser distance sensors with up to 10-meter range can be positioned outside the press envelope to confirm sheet placement and removal before and after each stroke.
- Banner safety products, including S4B light curtains and SX5 safety laser scanners, ensure that personnel are protected from injury in this high-risk environment.



**Q5X Photoelectric Sensors**  
(p. 21)



**S4B Heavy-Duty Type 4 Safety Light Curtains**  
(p. 28)



**SX5 Safety Laser Scanners**  
(p. 28)



## Stamped Part Detection

### Challenge

Reliable detection of stamped metal parts is important as they are conveyed out of the final press. The parts might be of various shapes and sizes, and they can have punched holes, depending on the production run. This makes a single-point sensor solution unreliable for continuous detection.

### Solution

- Banner's LX Series sensing array generates a cross-hatch beam pattern for extraordinary sensitivity to small objects and continuous detection of parts as they travel down a conveyor.
- LX sensors feature robust metal construction, so they are well suited for the harsh environment of stamping stations, which may incorporate cutting fluids and feature high levels of vibration.



**LX Part Sensing Light Curtains**  
(p. 23)



# Body Shop

Various components are combined to form a strong vehicle base: the body. The body shop is one of the vital production steps in automotive production. Banner offers sensors for reliable detection and error-proofing, as well as safety solutions that protect personnel and equipment.



## Adhesive Bead Detection

### Challenge

During the assembly of car doors, adhesive is applied along the perimeter of the outer panel. The outer and inner panels are joined together by a press. If too little adhesive is applied, the panels will not adhere correctly. If too much adhesive is applied, it may burst through the seams, requiring cleanup.

### Solution

- A VE Series Smart Camera inspects each door panel for the presence and consistency of adhesive.
- The camera has a wide field of view and a 5 MP imager capable of detecting even slight inconsistencies in the amount of adhesive applied.



VE Smart Cameras  
(p. 33)

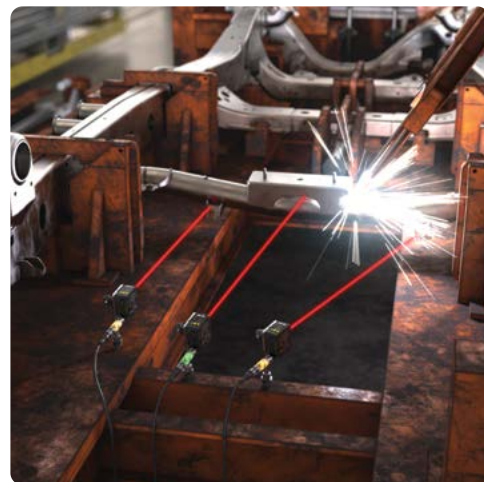

## Part Presence and Position Verification

### Challenge

As the frame of a vehicle is manufactured, components are welded together specific to the model planned for production. Confirming the absence and presence of components is needed for quality and model verification in this harsh environment.

### Solution

- The Banner Q5X sensor excels in error-proofing applications where long-distance detection is needed for challenging surfaces and environments.
- The Q5X laser measurement sensor has excellent optical performance to reliably detect dark and angled surfaces. Because of its long range (up to 10 meters) it can be placed outside hostile environments such as welding operations.



Q5X Photoelectric Sensors  
(p. 21)



## Feeder Bowl Fill Level

### Challenge

Feeder bowls serve an important role in automated assembly, vibrating to sort screws and other small parts into proper orientation. But if a feeder bowl runs empty, the assembly process comes to a halt until the bowl is refilled.

### Solution

- A Q4X Series sensor can be positioned above a feeder bowl, pointing downward, to detect the fill level. This can be used to automate refilling, so that the bowl never runs empty during production.
- Q4X sensors are particularly well suited to this task because they can easily detect black targets, including black screws, caps, or other challenging components.



Q4X Laser Distance Measurement Sensors  
(p. 21)

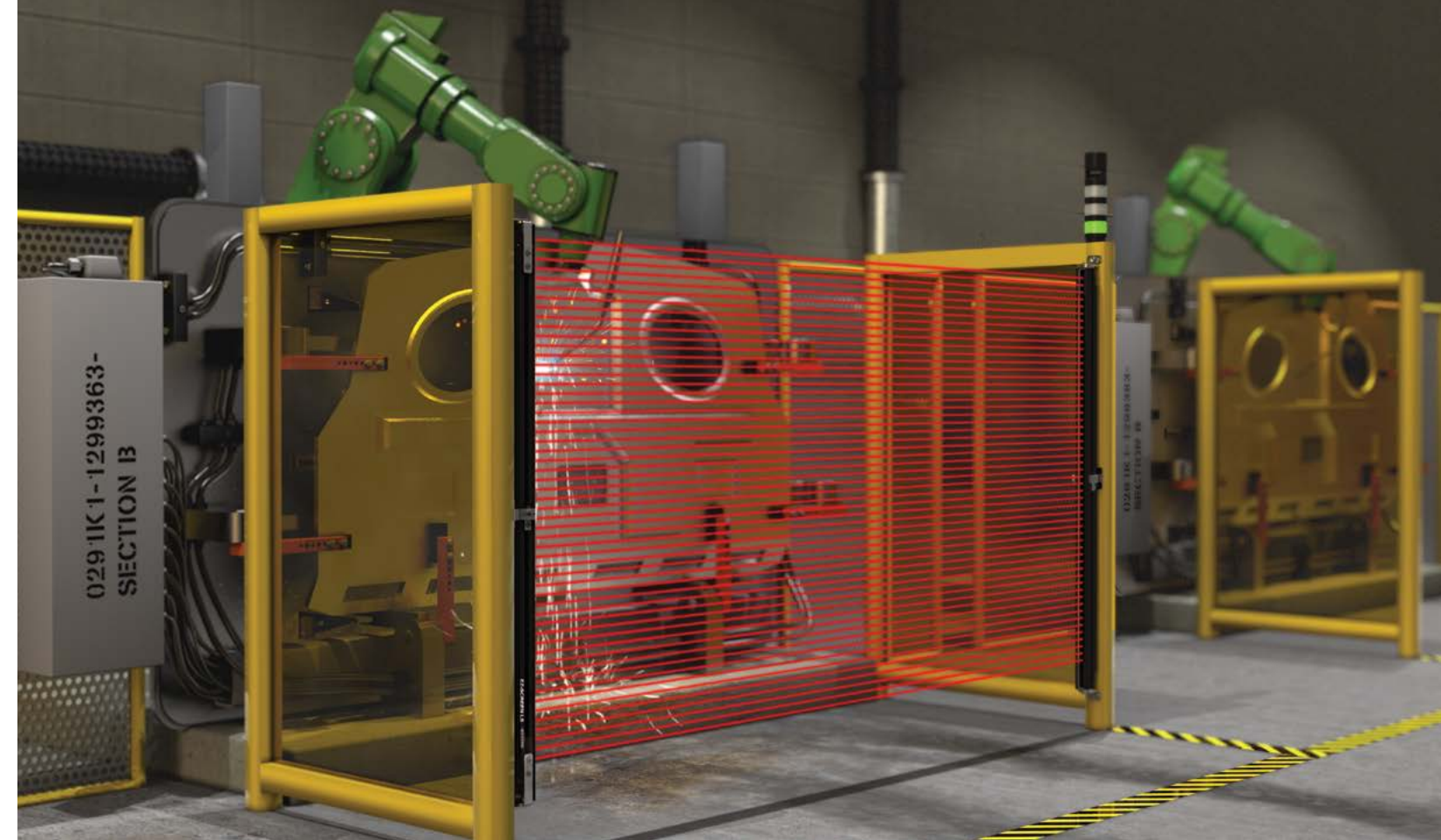

## Safeguarding a Manual-Load Welding Station

### Challenge

A variety of semi-automated operations that involve the manual feeding and/or removal of parts exist within the automotive manufacturing process. In this robotic weld cell, operators must be protected from hazards that are created by the automation such as pinch points from clamps and feed-table movement.

### Solution

- The EZ-SCREEN® LS is a well-established solution for the harsh requirements of welding equipment, with the ability to cascade (series connect) multiple segments together. Configurations such as this vertical pair are easily implemented with standard hardware (no master/slave models).
- The TL70 tower light provides highly visible operator guidance and equipment indication.



EZ-SCREEN® LS Safety Light Curtains  
(p. 28)



TL70 Audible Tower Lights  
(p. 27)



## Body Shop Operator Station

### Challenge

Equipment operators in work cells need ways to start cycles, initiate emergency stops, and receive indications for machine status. Operator stations with dedicated controls are needed, but their designs must be robust and easy to deploy and maintain.

### Solution

- Self-contained actuators and LED indicators designed for harsh duty.
- With quick disconnect (QD), these products are simple to assemble and replace.
- There is no need to build custom enclosures with discrete components.



Emergency Stop Buttons  
(p. 29)



K50 Indicators  
(p. 26)



STB Safety Touch Buttons  
(p. 29)



# Paint Shop

The automotive paint shop is a zero-fault-tolerance environment, and it requires solutions to have high availability, energy efficiency, and reliability even in harsh conditions. Banner sensors and systems are designed to perform reliably in this demanding environment.



## Light Tunnel for Paint Inspection

### Challenge

In a recent automotive application, operators were complaining of eye strain when inspecting vehicles in the paint tunnel. Scratches and marks on the raw materials were missed during final inspection, causing delays in production. The warehouse manager wanted a light to reduce worker fatigue, eliminate defects, and allow proper inspection.

### Solution

- The WLB72 Inspection reduces shadows, improves visibility, and gives workers the light they need to work efficiently and without making mistakes. The focused beam of the WLB72 enables workers to see contrast.
- The black edges shielded workers from direct contact with the light when looking down the length of the tunnel.



**WLB72i LED Strip Lights**  
(p. 25)



## Predictive Maintenance Monitoring

### Challenge

In the paint shop are a lot of critical devices like pumps and drives, which need to be checked frequently for proper operation.

### Solution

- Banner's vibration and temperature sensor measures RMS velocity, in inches per second or millimeters per second, and temperature.
- By monitoring motors, pumps, compressors, fans, blowers, and gearboxes for increases in vibration, problems can be detected before they become too severe and cause damage or unplanned downtime.



**QM30VT1 Vibration and Temperature Sensors**  
(p. 32)



## Paint Booth Lighting

### Challenge

The paint booth in an automotive manufacturing plant is a challenging environment due to its hazardous location requirements. Explosion-proof lighting is prohibitively expensive to place inside, so it is often preferred for LED lighting to go outside of the booth.

### Solution

- The WLB72 Basic LED light bar provides high quality 5000K daylight white illumination with dimming control to meet the needs of general booth task lighting applications
- The energy efficient WLB72 design and flexible mounting options dramatically reduces installation time when compared to traditional florescent fixtures while bringing long life to minimize maintenance costs



**WLB72 LED Strip Lights**  
(p. 25)



## In-Panel Temperature and Humidity Monitoring

### Challenge

Excessive heat and humidity inside a control panel can damage sensitive electronic equipment. Shorter equipment lifespans, corrosion, and sudden failure all can create unplanned downtime.

### Solution

- A compact S15S Temperature and Humidity Sensor can be installed in a control panel to monitor environment conditions.
- Data from the S15S can be sent to a connected DXMR90 Industrial Controller for processing at the source, then sent wirelessly via an R70 Data Radio for remote monitoring.



**R70 Data Radios**  
(p. 32)



**DXMR90 Industrial Controllers**  
(p. 30)



**S15S Temperature and Humidity Sensors**  
(p. 32)

Learn more about Snap Signal on page 34



## Car Detection in a Paint Booth

### Challenge

Different vehicle models and colors run through the paint shop. Tracking each body along the line requires a robust sensing technology.

### Solution

- Banner's T30R series of radar sensors can identify objects with uneven surfaces; or parts that are glossy, reflective, matte black, or any other color.
- Radar has distance measurement capability allowing sensing windows to be established for varying vehicle body dimensions.



**T30R Radar Sensors**  
(p. 23)



# Powertrain

Today, the automotive powertrain requires a high variety of models, in combination with shorter life cycles, cost-efficient manufacturing and optimized logistic processes. Banner sensors and solutions enable process optimization, save costs, and improve quality.

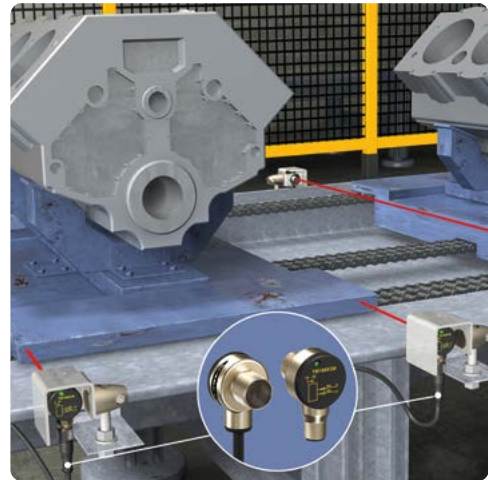

## Heavy-Duty Part Positioning

### Challenge

In heavy-duty applications, sensors can be easily damaged during machine assembly, transport, maintenance, and operation.

### Solution

- The right choice in harsh environmental conditions is the TM18 sensor. The nickel-plated, die-cast zinc, IP69K-rated design is the perfect solution for washdown applications and industrial environments where a compact and heavy-duty design is vital to prevent damage to the sensor.
- With a right angle shape, and an 18 mm threaded barrel mount, the TM18 readily fits into tight spaces.



**TM18**  
Heavy-Duty Metal  
Right Angle  
Sensors  
(p. 22)



## Visual Management for Assembly

### Challenge

Visual management in assembly applications helps workers identify next steps in the process, improve efficiency, and reduce errors.

### Solution

- The large 50 mm translucent domes have highly visible LEDs for clear indication.
- The ergonomic design of the touch buttons requires no physical pressure to operate, preventing stress on hands and wrists.



**K50**  
Touch Buttons  
(p. 26)

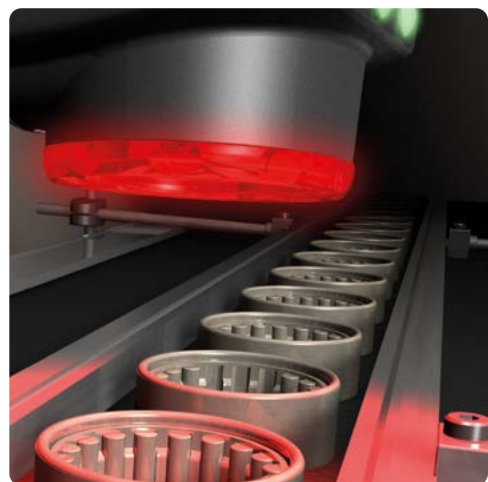

## Bearing Inspection

### Challenge

Roller bearings are used extensively in automobile manufacturing. If one or more of the rollers are missing, it increases the chance that a part will wear out prematurely.

### Solution

- An iVu Series sensor configured for a Match inspection ensures that all the bearings are present for each component.
- If the sensor detects one or more missing bearings, it sends a fail output to the line, and the component is rejected.



**iVu Vision Sensors**  
(p. 33)

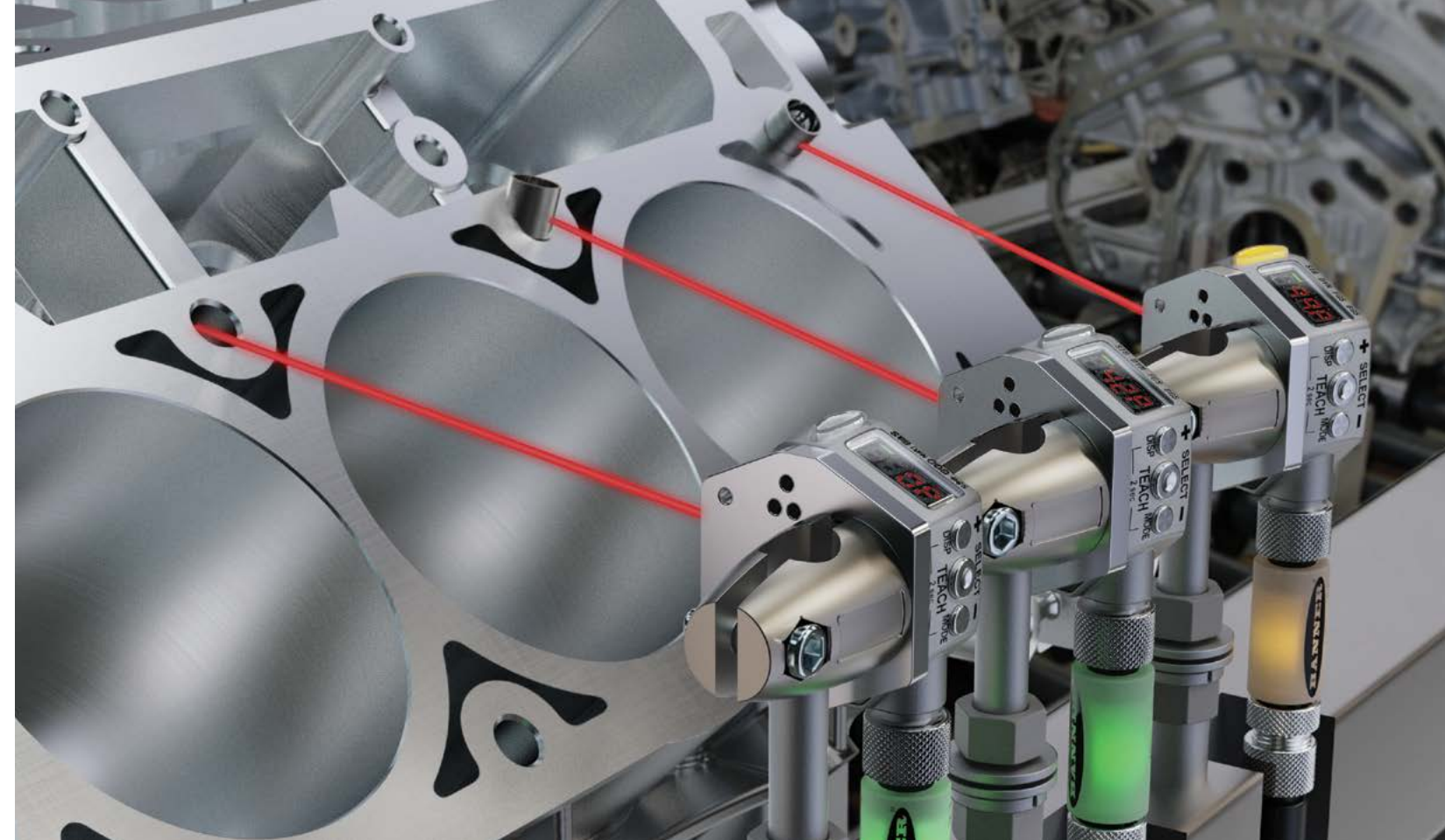

## Engine Block Error-Proofing

### Challenge

With complex assemblies, it is critical to ensure each step in the process is completed correctly prior to moving onto the next work station. For engine assembly, verifying inserts and alignment pins are present and correctly placed is essential for quality and reliable operation.

### Solution

- Banner's Q4X precision laser distance sensor can reliably detect shiny and angular surfaces with repeatability down to .2 mm.
- An S15L indicator accessory can be connected for clear local status of pass/fail.
- Discrete, analog, or IO-Link models adapt to any control platform requirements.



**Q4X Laser Distance  
Measurement Sensors**  
(p. 21)



**S15L In-Line Sensor  
Status Indicators**  
(p. 25)



## Crankshaft Runout Measurement

### Challenge

A crankshaft can be a challenging target for optical sensors, because the shiny metal generates specular reflections while oil residue can present a much darker target. Crankshafts tend to be rotated quickly during production.

### Solution

- The LM150 laser displacement sensor features dynamic power adjustment for precision measurement across shiny and dark targets, providing less measurement variation and more reliable inspections.
- High measurement speeds (up to 4 kHz) allow the LM150 to better identify a problem on fast-moving parts while reducing the time required for inspections.



**LM Laser  
Measurement Sensors**  
(p. 22)



# EV Battery Production

Electric vehicle manufacturing has unique challenges in QC and safety. The industry demands precision control of processes for producing lithium batteries, electric motors and charging systems. Banner offers trusted solutions, like battery-electrode-film thickness measurement and machine safeguarding for battery-pack assembly.



## Reliably Detect Adhesive Tape on Pouch Batteries

### Challenge

Adhesive tape material is used to complete the outer film packaging, and the tape can be various colors depending on the production run. A standard contrast sensor can't reliably detect various colors on undulating surfaces, so they are impractical.

### Solution

- The QCM50 color sensor can store up to 12 colors, which can be confirmed through as many as 5 discrete outputs or IO-Link communication.
- Models are available with ranges up to 150 mm and are tolerant to variations in target distance changes due to irregular pouch surfaces.
- Glare suppression models can be deployed for more problematic, shiny surfaces.



**QCM50  
Color Sensors**  
(p. 22)

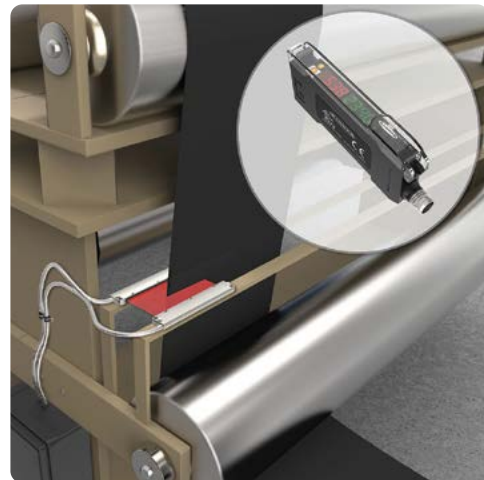

## Electrode Film Edge Guiding for Battery Manufacturing

### Challenge

Lithium-ion battery assembly combines rolls of anode, cathode, and separator film into a larger roll of electrode film. Poor edge guiding creates waste and compromises quality throughout the process.

### Solution

- A high-power fiber optic amplifier like the DF-G3 Series paired with a plastic fiber array reliably identifies the edge of the material based on the light intensity resulting from fully or partially blocked beams.
- If the material shifts to the left or right—the machine uses the real-time sensor data to automatically adjust the roll and realign the material.



**DF-G3  
Long Range Fiber  
Optic Amplifiers**  
(p. 22)

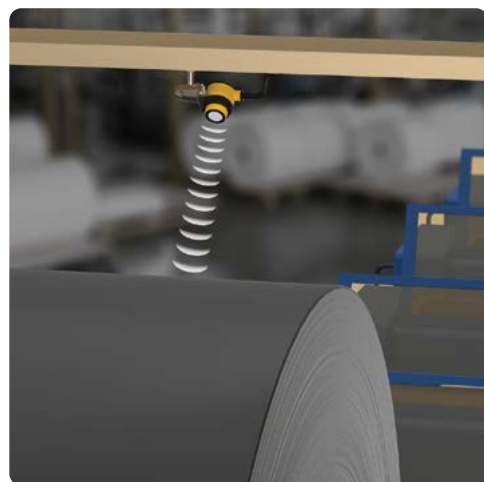

## Lithium-Ion Battery Electrode Film: Roll-Diameter Measurement

### Challenge

Large rolls of anode and cathode material feed the front-end battery coating and drying process. Monitoring the roll diameter in the unwind and wind stations are needed to track production and prepare for the next roll.

### Solution

- The T30UX is unaffected by the target's color and irregular surface qualities.
- Easily configure output types, response speeds, sensing ranges, and more.



**T30UX Ultrasonic  
Sensors**  
(p. 23)



## EV Lithium Battery Electrode-Film-Thickness Quality Control

### Challenge

Quality control is critical to reduce downtime and scrap, and maintain high quality standards so the finished product functions as intended for its useful life. Electrode thickness measurements are made after the coating and roll press processes. At these points, it's critical to measure the electrode film thickness to determine if it was applied correctly, evenly, and whether any is missing.

### Solution

- The LM's precise resolution of 0.002 mm and small spot size can identify subtle changes in distance that could indicate missing or uneven electrode application.
- As the battery-electrode film moves, the sensor tracks the measurements instantly and accurately with a 0.5 millisecond response speed.



**LM Laser  
Measurement  
Sensors**  
(p. 22)



## Tank Level Monitoring

### Challenge

Various raw materials and slurry used in battery electrode coating is contained in tanks need to be monitored for proper level to keep the process flowing.

### Solution

- The T30R radar distance sensor is a proven technology to measure the level of liquid and dry bulk materials having models out to 25 meter range and repeatability down to 1 mm.
- Using high-frequency radar and its near-range dead zone, the T30R brings the added benefit of scanning through enclosed plastic tanks if need be.



**T30R Radar Sensors**  
(p. 23)



# General Assembly

Automotive assembly lines require a flexible JIT/JIS flow of material mixed with continuous quality checking and tracking. Proper station lighting, light guided assembly, and other error proofing is critical for success. Banner solutions enable customers to optimize processes and save costs.



## Control Cabinet Lighting

### Challenge

Cabinets and enclosures require proper illumination for tasks such as component installation, maintenance, and monitoring. A maintenance technician needs a bright, ergonomic light source to wire relays and perform other tasks.

### Solution

- The WLS15 provides brilliant, bright LED illumination and features a compact, low-profile design, ideal for use in tight and confined areas.
- The WLS15 draws less current than other lights for a low power device and high energy savings.
- Rugged construction and a polycarbonate shell resists shock and vibration while remaining lightweight.



**WLS15  
LED Strip Lights**  
(p. 24)

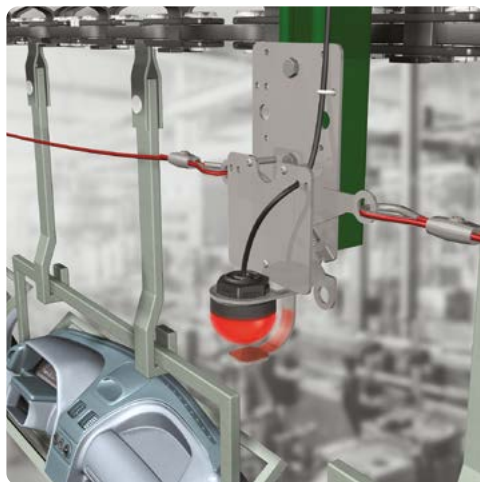

## Quality or Process Problem Detection

### Challenge

Andon is part of a quality management system. The task is to provide a reliable, highly visible, and cost-effective solution for an Andon rope-pull application.

### Solution

- The Banner rope pull bracket used with a K50 indicator offers flexible rope mounting and provides significant cost savings by eliminating old-fashion junction boxes.
- Optional hosting of a wireless node gives additional installation flexibility.



**K50 Optical Sensors**  
(p. 26)

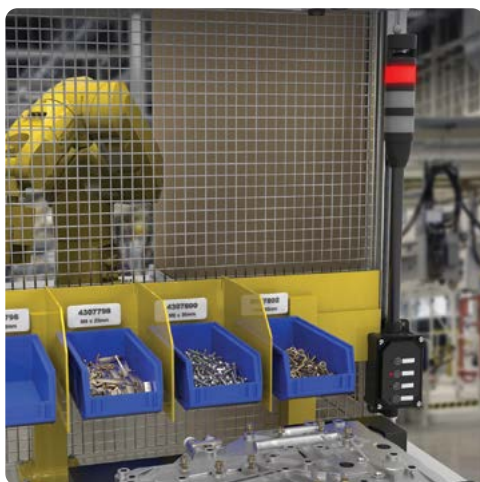

## Improved Efficiency at Assembly Workstations

### Challenge

Facility manager wanted to upgrade their existing assembly workstation process to reduce downtime. To improve efficiency, the assemblers needed a reliable way to call for parts without leaving their workstations.

### Solution

- A TL50 Andon Tower Light was mounted at the top of each workstation for clear status indication.
- The control box allows operators to communicate various station need requirements such as parts shortage, maintenance support, etc.



**TL50 Andon Lights**  
(p. 27)

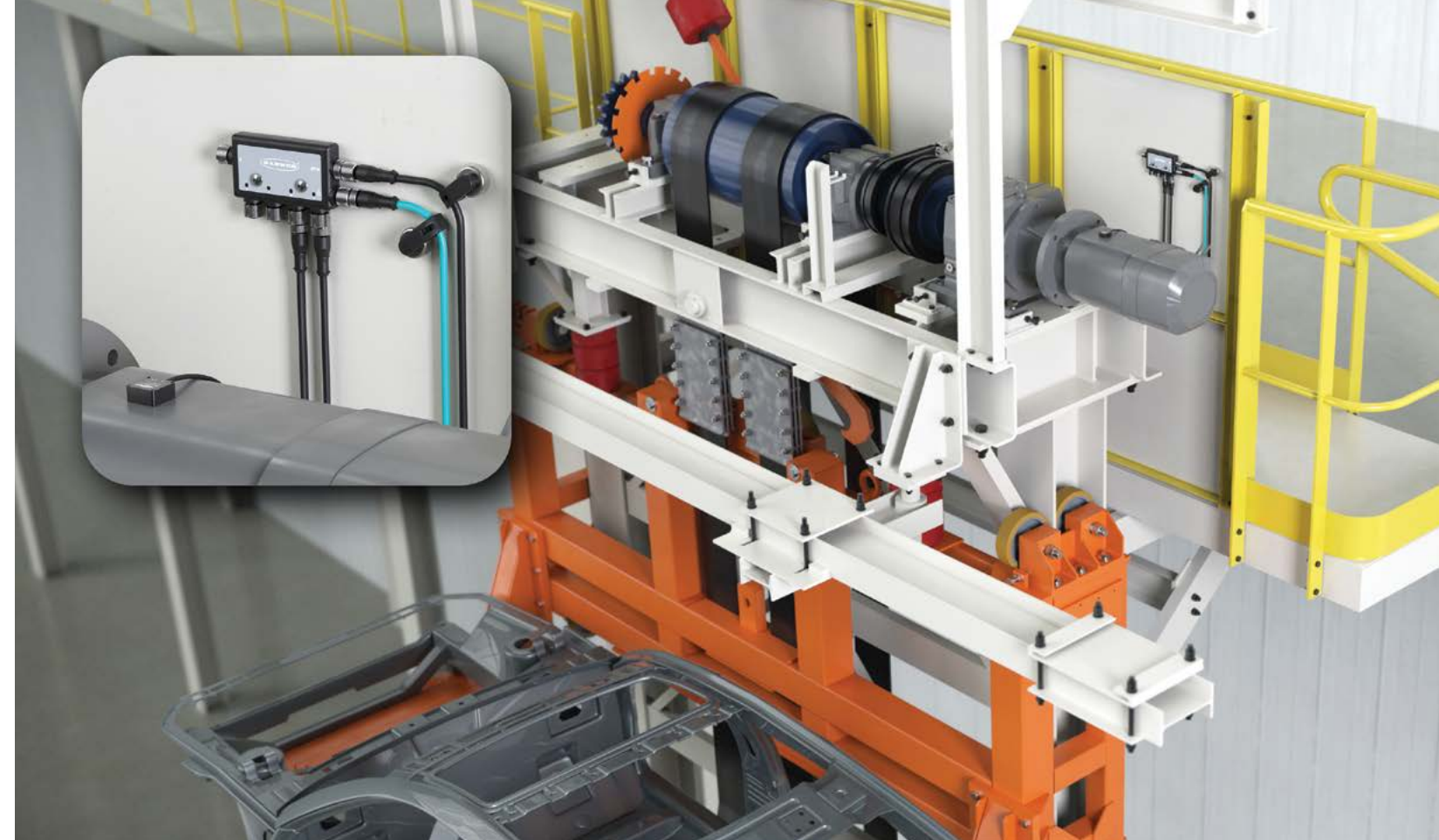

## Temperature and Vibration Monitoring on Lift Motors

### Challenge

Ensure lift motors perform reliably to facilitate smooth production and eliminate unplanned shutdowns.

### Solution

- QM30VT Vibration and Temperature Sensor (paired with DXM90 Industrial Controller) helps keep motors healthy, reducing or eliminating unplanned production shutdowns.
- Monitors motor health by tracking key performance indicators, temperature, and vibration, allowing maintenance team to keep motors in optimal condition.
- The solution allows plants to see gradual performance declines long before they become a problem, so motors can be serviced during scheduled shutdowns.



**DXM90 Industrial  
Controllers**  
(p. 30)

Learn more about Snap Signal  
on page 34



**QM30VT1  
Vibration and  
Temperature Sensors**  
(p. 32)



## Operator Guidance for Assembly

### Challenge

Today's assembly processes are based on continuous error proofing to achieve a target of zero defect. The Banner PTL (pick-to-light) sensors help operators pick parts accurately and efficiently.

### Solution

- Visual indication helps ensure operators pick the correct parts and easily handle diverse part combinations.
- More reliable and efficient part picking saves time and increases the quality of assemblies.



**PTL110  
Pick-to-Light Devices**  
(p. 27)



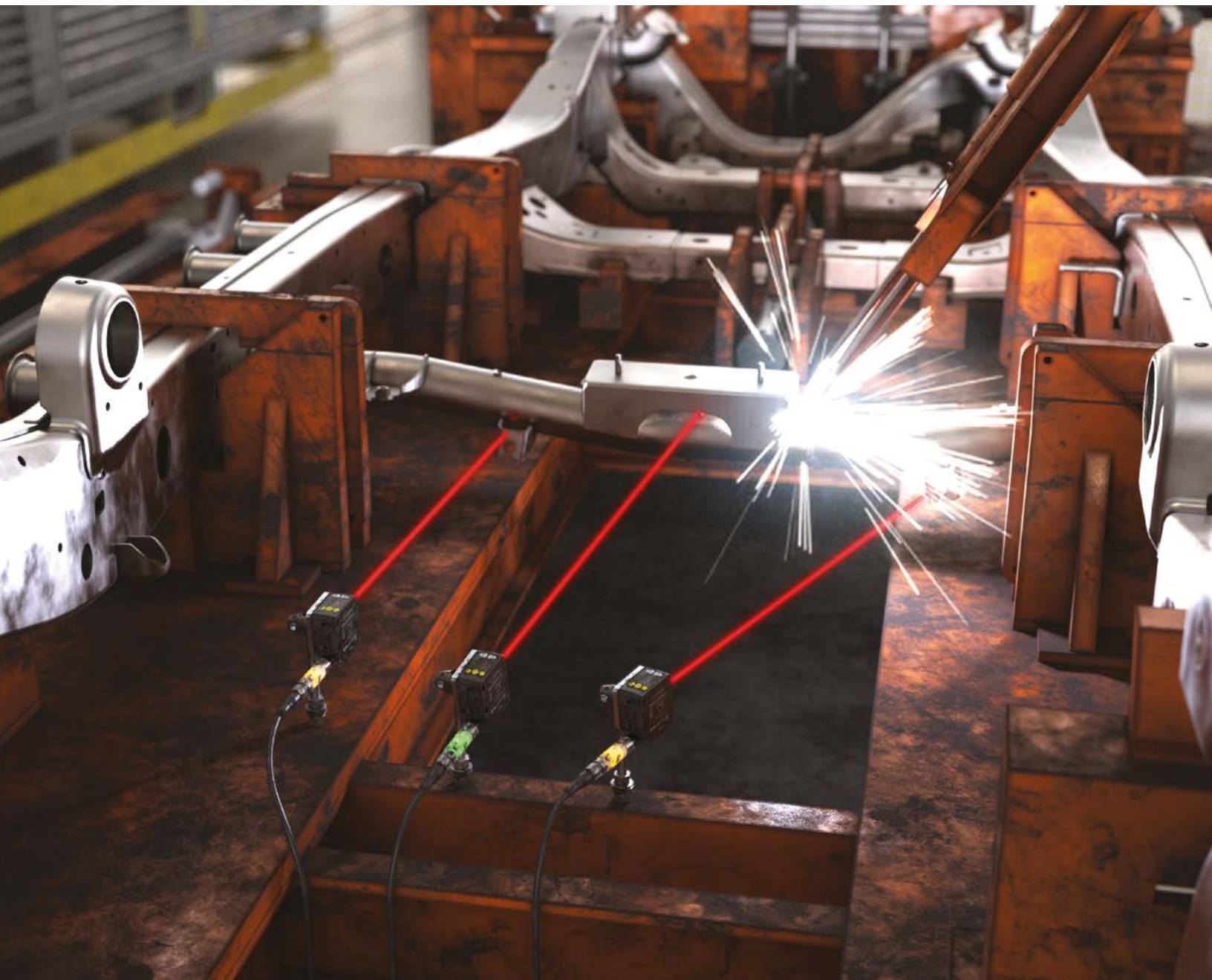
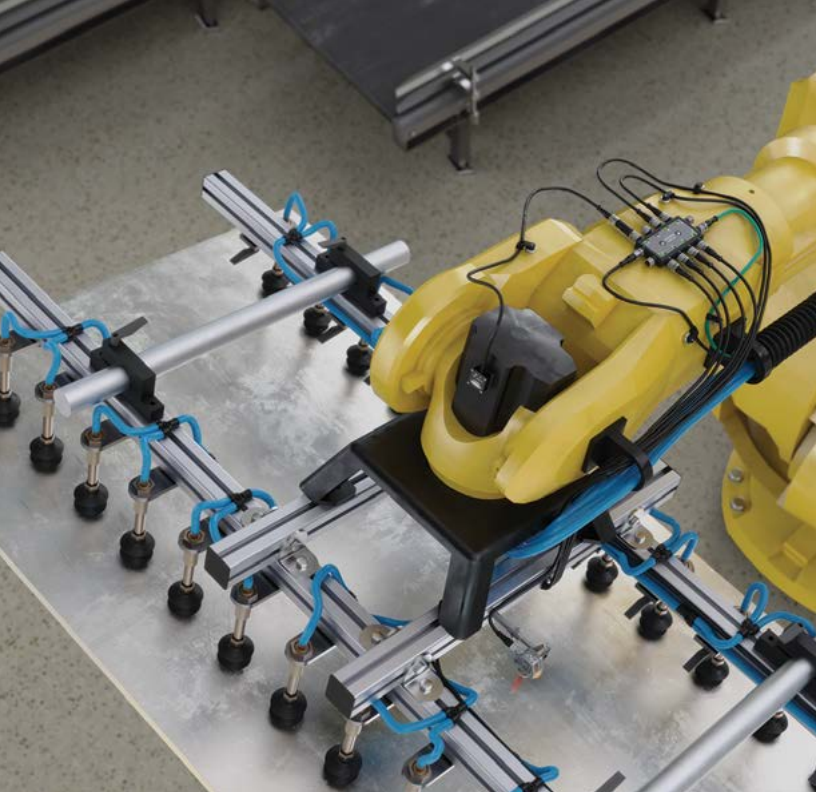

# Sensor Solutions

## Q4X Laser Distance Measurement Sensors



Family	Housing Style	Output	Mode	Range	Connector
<b>Q4X</b>	<b>T</b>	<b>B</b>	<b>LAF</b>	<b>100</b>	<b>Q8</b>
	T = 18 mm Threaded Barrel	B = Bipolar discrete NPN & PNP K = Dual discrete with IO-Link U = 0–10 V analog I = 4–20 mA analog	LAF = Laser adjustable-field	100 = 25–100 mm 300 = 25–300 mm 500 = 25–500 mm* 600 = 25–600 mm	Q8 = Integral QD <small>QD models require mating cordset</small>
	<small>*Not available with dual discrete with IO-Link output models</small>				
Family	Housing Style	Output	Mode	Range	Connector
<b>Q4X</b>	<b>F</b>	<b>N</b>	<b>LAF</b>	<b>110</b>	<b>Q8</b>
	F = Flush mount	N = NPN P = PNP K = Dual discrete with IO-Link U = 0–10 V analog I = 4–20 mA analog	LAF = Laser adjustable-field	110 = 35–110 mm 310 = 35–310 mm 610 = 35–610 mm	Q8 = Integral QD <small>QD models require mating cordset</small>

## Q5X Laser Measurement Sensors



Series	Output	Emitter	Mode	Range (mm)	Connector	Options
<b>Q5X</b>	<b>K</b>	<b>L</b>	<b>AF</b>	<b>2000</b>	<b>Q8</b>	<input type="checkbox"/>
	K = Configurable dual discrete with IO-Link on all models KU = 0–10 V with push/pull discrete output or IO-Link KI = 4–20 mA with push/pull discrete output or IO-Link	L = Laser	AF = Adjustable-field background suppression	2000 = 2000* 3000 = 3000** 5000 = 5000* 10000 = 10000*	Q8 = Integral swivel M12 connector	-Jam = Jam model* Blank = Standard model
	<small>*K models available in 2000 or 5000 mm range only **KU and KI models available in 3000 mm range only †Jam model available in 2000 mm range only</small>					

## LE Laser Measurement Sensors



Family	Range	Output	Laser Class	Connector
<b>LE</b>	<b>550</b>	<b>I</b>	<input type="checkbox"/>	<b>Q</b>
	550 = 100–1000 mm 250 = 100–400 mm	I = 4–20 mA analog and (1) NPN/PNP discrete U = 0–10 V analog and (1) NPN/PNP discrete D = (2) NPN/PNP discrete K = IO-Link and (1) PNP discrete	Blank = Class 2 C1 = Class 1	Blank = 2 m integral cable Q = Rotatable M12 QD QP = PVC M12 pigtail QD W/30 = 9 m integral cable <small>QD models require mating cordset</small>
	<small>NOTE: Discrete NPN/PNP is user configurable</small>			

Note: Not all models are shown. Visit [bannerengineering.com](http://bannerengineering.com) for other available models.



# Sensor Solutions

## LM Laser Measurement Sensors

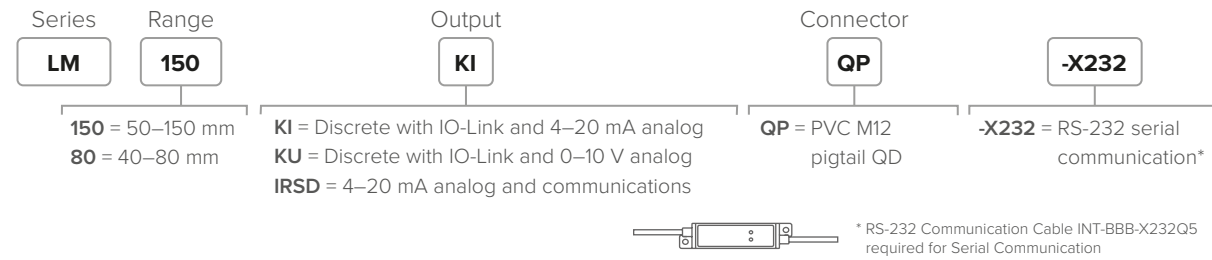

## TM18 Heavy-Duty Metal Right Angle Sensors

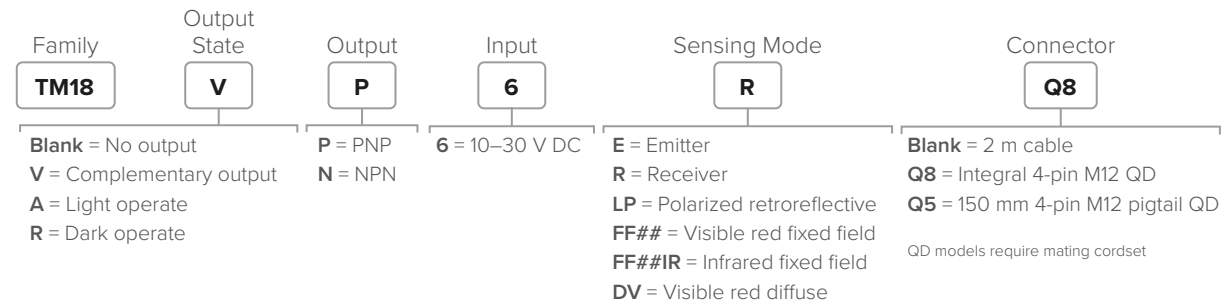

## QCM50 Color Sensors

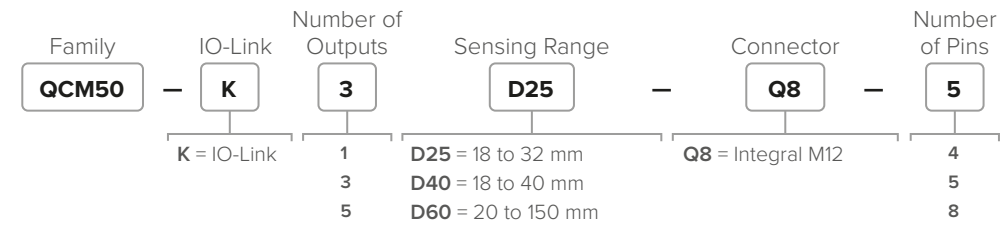

## DF-G3 Fiber Optic Amplifiers

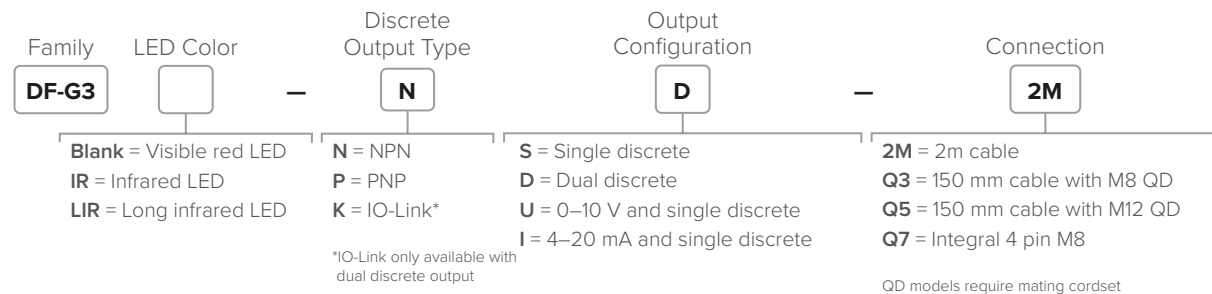

## T30R Radar Sensors

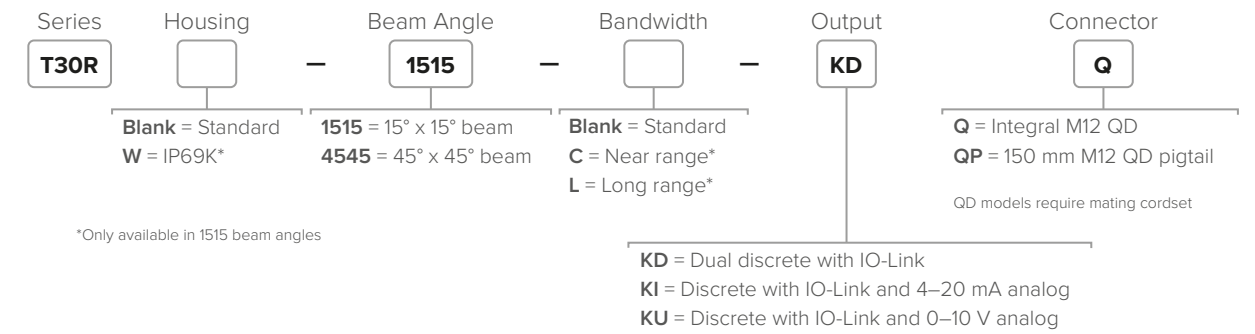

## T30UX Radar Sensors

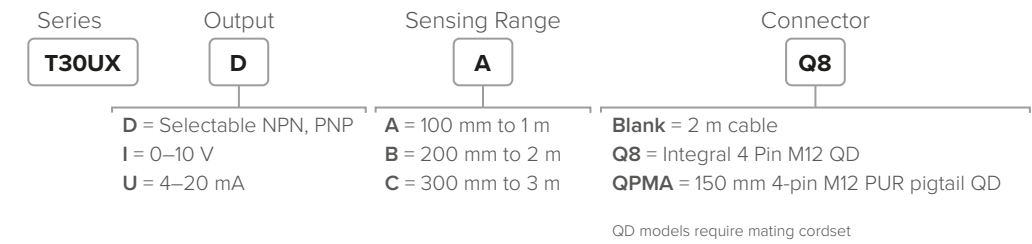

## LX Small and Flat Object Detection Sensors

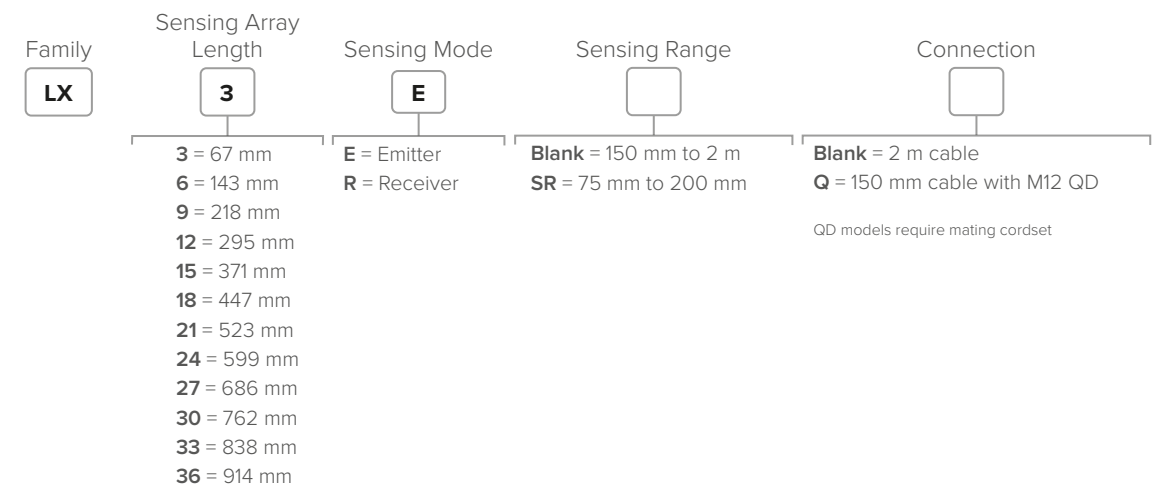



# Lighting and Indication Solutions

## WLS15 LED Strip Lights

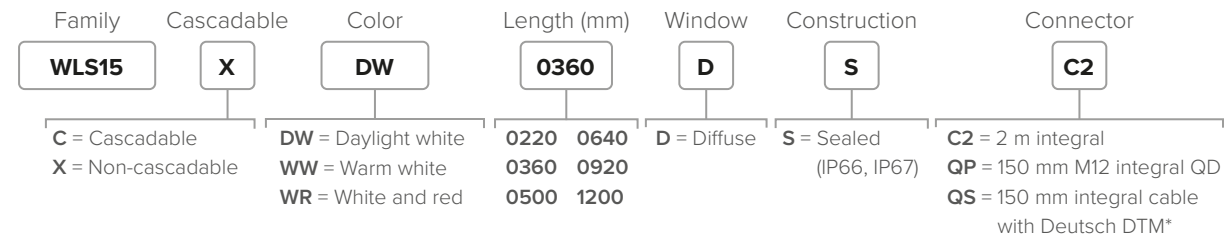

### High Intensity Models

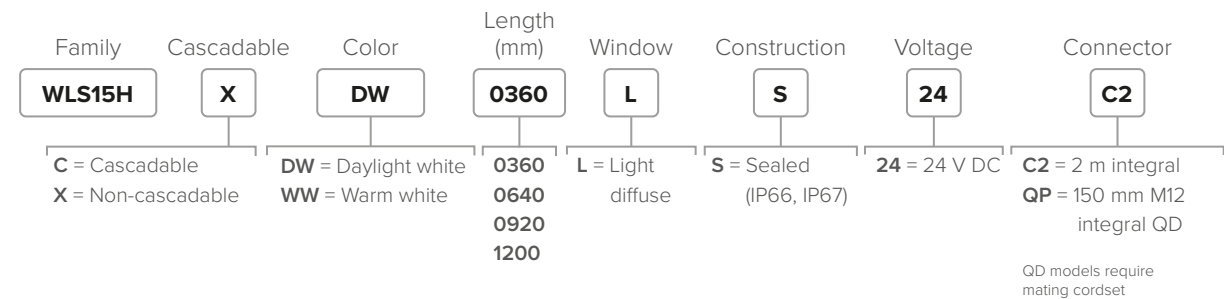

## WLB32 LED Strip Lights

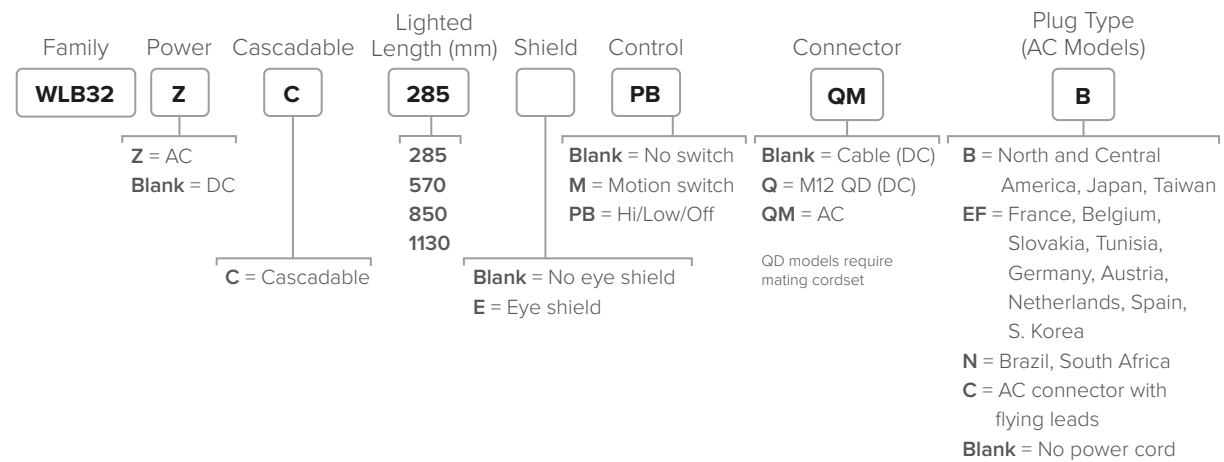

## WLS27 LED Strip Lights

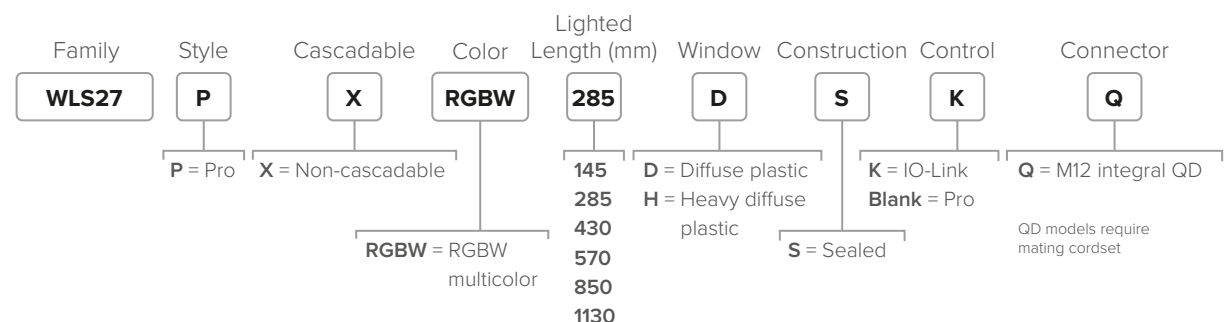

## WLB72 LED Light Bars

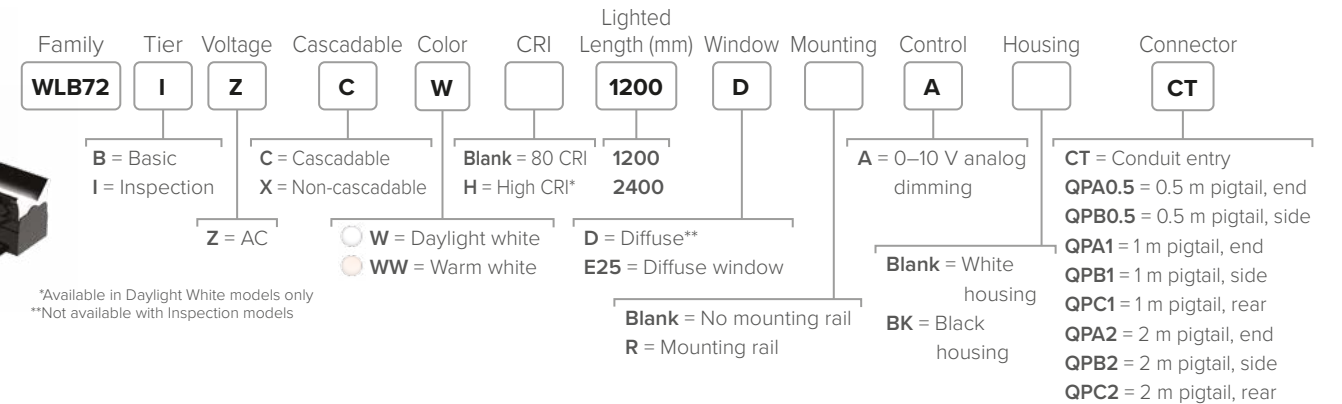

## S15L In-Line Status Indicators



Power ON (Color 1)	Input Active (Color 2)	Input Type	Connection	Models
Green	Yellow	PNP	4-pin male/female M12 quick disconnect	<b>S15LGYPQ</b>
	Red	NPN		<b>S15LGYNQ</b>
Red	Green	PNP		<b>S15LGRPQ</b>
	Yellow	NPN		<b>S15LGRNQ</b>
				<b>S15LRGPQ</b>
				<b>S15LYGPQ</b>

## K100 Pro Indicator Beacons

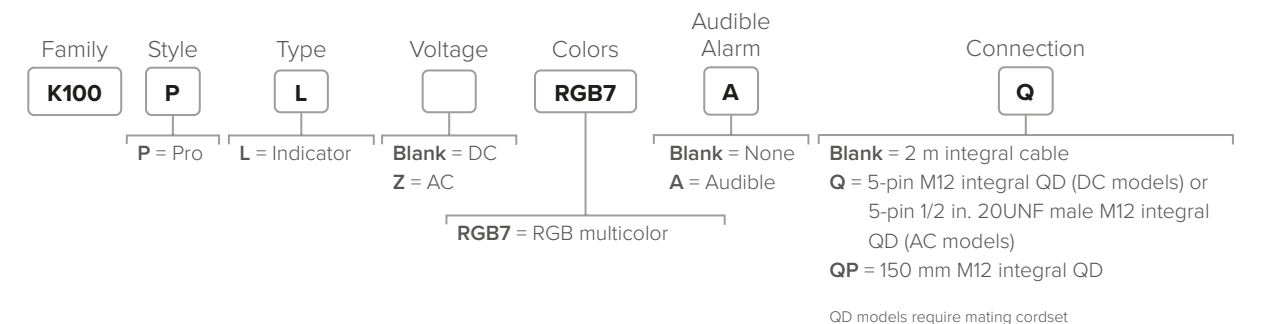



# Lighting and Indication Solutions

## K70 Touch Buttons



Colors	Function	Output	Connection	Models
Green, red	Job light is green while job input is active. Touch activates output.	PNP	4-pin M12 integral QD	K70APT2GRCQ
				K70APT2GREQ
Green, red, yellow	Multipurpose Job light always on with job input until touched. Touch activates output and overrides job light with sense light. Touch with inactive job input activates mispick light and activates output.			K70APT2GRYF2Q K70APT2GRYC3Q

## K50 Multicolor Indicators



## K50 Touch Button Indicators

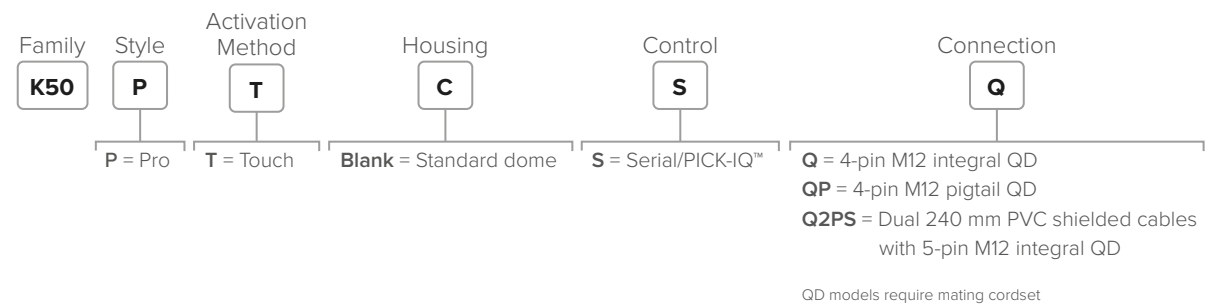

## K50 Optical Indicators

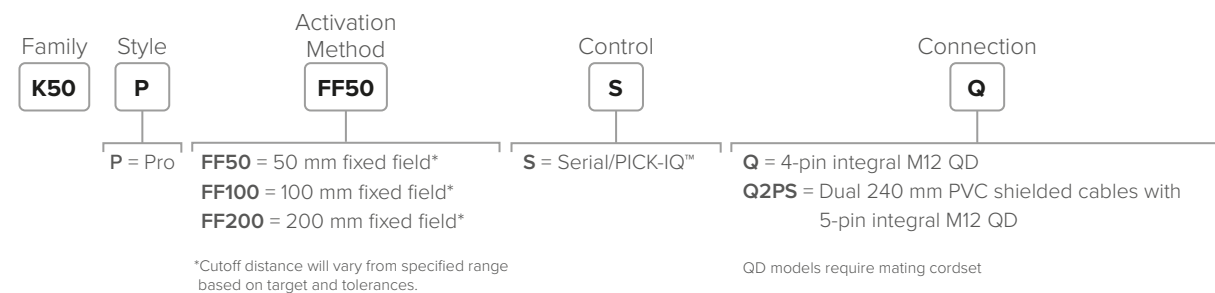

## TL70 Tower Lights

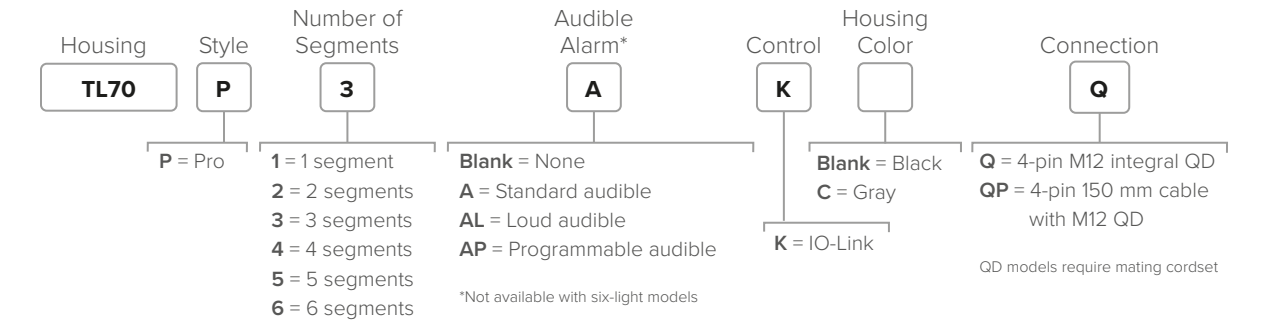

## TL50 Andon Tower Lights

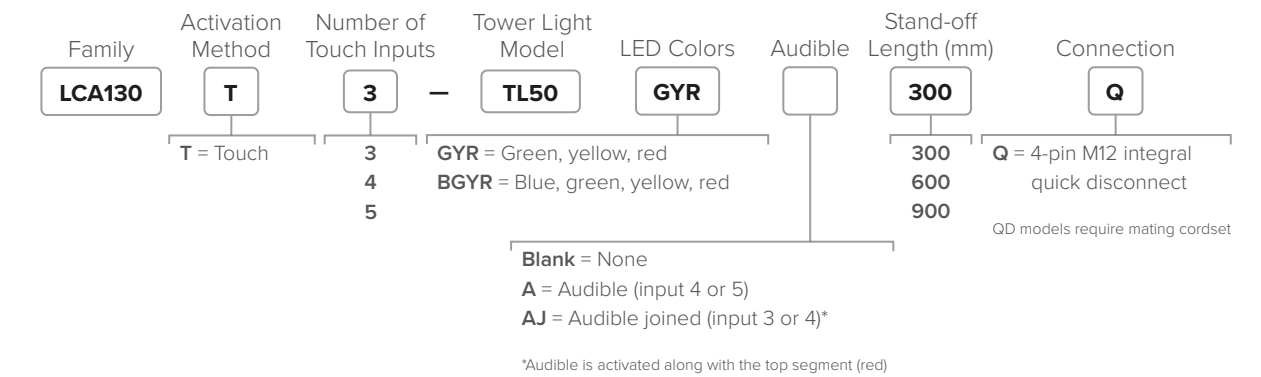

## PTL110 Pick-To-Light Devices

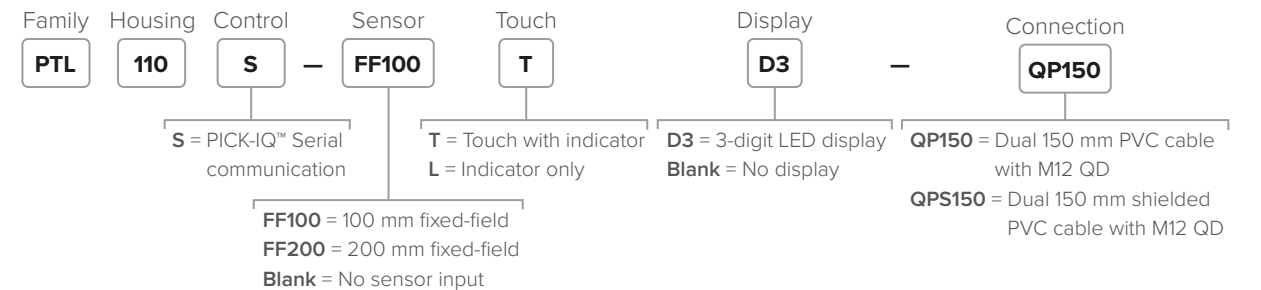



# Machine Safety Solutions

## S4B Safety Light Curtains

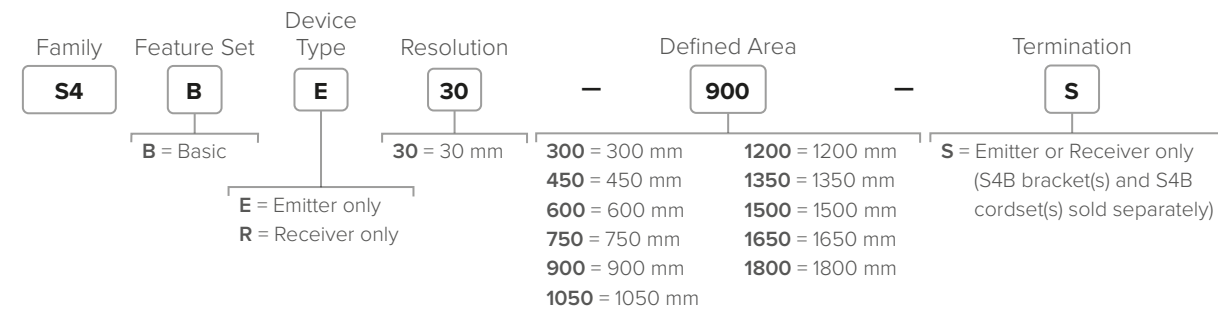

## EZ-Screen LS Safety Light Curtains

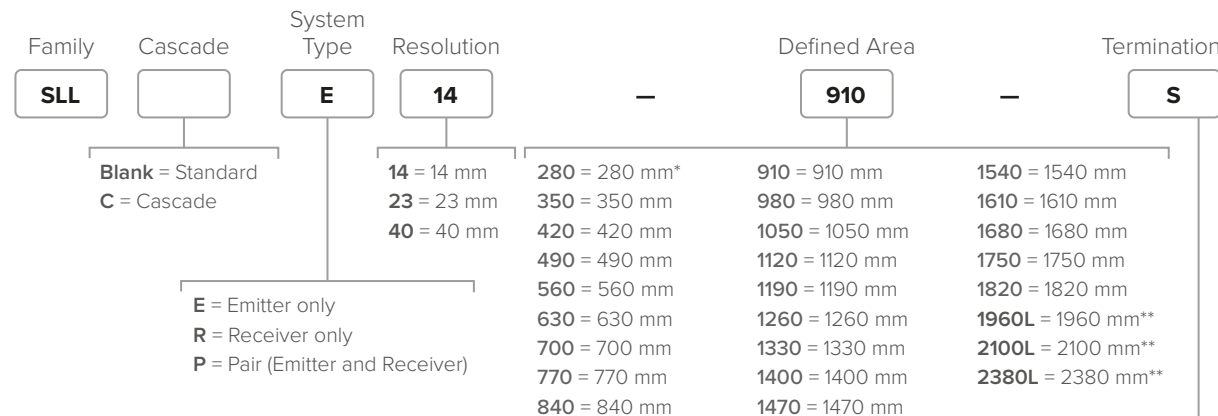

S = Emitter or receiver only (LS bracket(s) and LS cordset(s) ordered separately)  
 P5 = Emitter or receiver includes one LS M12 double-ended cordset (5-pin) and LS brackets (-11 and -12)  
 P55 = Pair includes two LS M12 double-ended cordsets (5-pin) and LS brackets (-11 and -12)  
 P8 = Emitter or receiver includes one LS M12 double-ended cordset (8-pin) and LS brackets (-11 and -12)  
 P88 = Pair includes two LS M12 double-ended cordsets (8-pin) and LS brackets (-11 and -12)  
 Blank = Emitter, receiver, or pair includes LS brackets (-11 and -12), LS cordset ordered separately

\*Not available in cascade models  
 \*\*23 mm resolution, IP65, 10 m range

## Emergency Stop Buttons

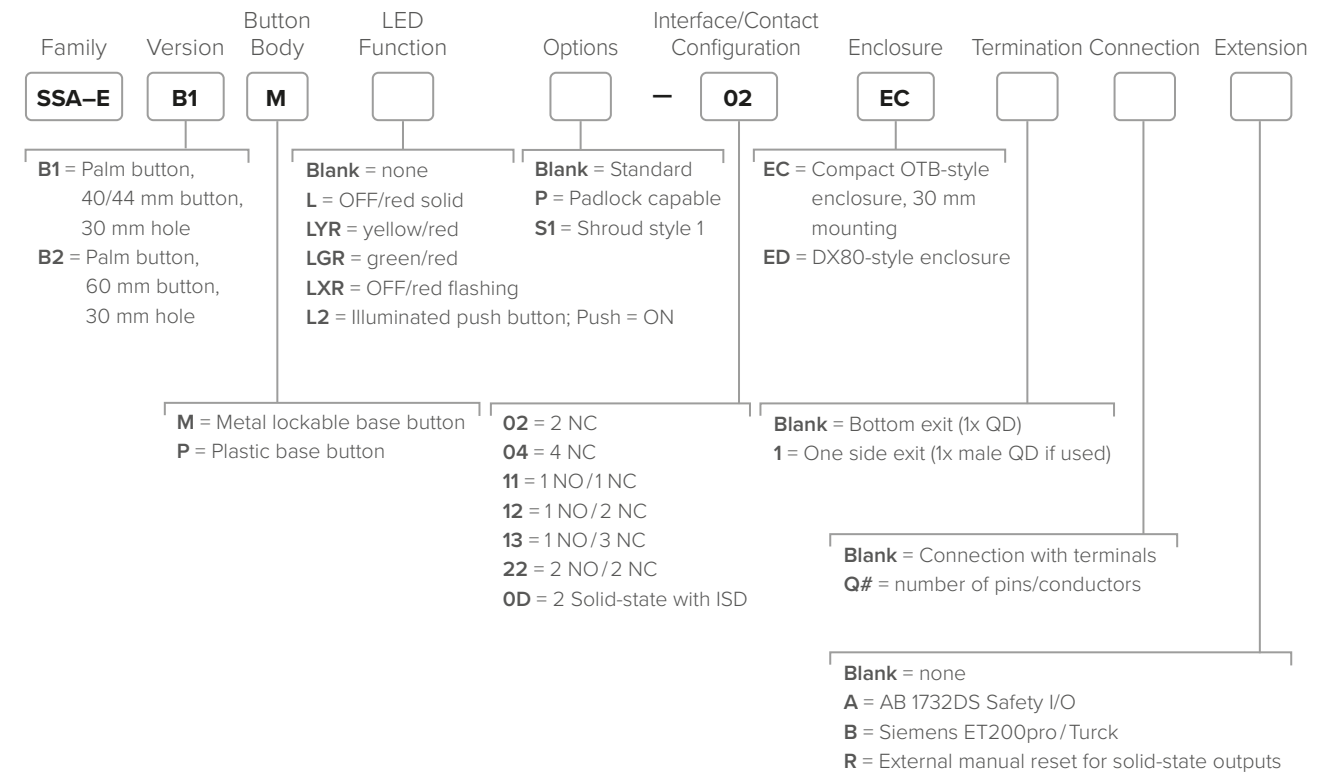

## STB Self-Checking Touch Buttons



Touch Surface Material	Output	Power Supply	Connection	Models
Polyetherimide (PEI)	Solid-state 2 Complementary PNP (1 ON, 1 OFF)	10-30 V DC	2 m cable	<b>STBVP6</b>
			4-pin M12 QD	<b>STBVP6Q5</b>
	E/M Relay 2 Complementary SPST (1 NC, 1 NO)	20-30 V AC/DC	2 m cable	<b>STBVR81</b>
			5-pin M12 QD	<b>STBVR81Q6</b>

STB buttons include yellow field cover to prevent unintended switching. To comply to safety standards, STB buttons must be used with appropriate two-hand control modules, SC26, XS26 or SC10 safety controller or comparable Type III C two-hand system.

## SX5 Safety Laser Scanners



Description	Max Safety Range	Connections (pins)	Models
Updated stand-alone model	5.5 m	8	<b>SX5-B6*</b>
Master model with encoder inputs		17 + 8	<b>SX5-ME70</b>
Master model		17 + 8	<b>SX5-M70</b>
		12 or 8	<b>SX5-M10</b>
Remote model		8	<b>SX5-R</b>

\*The SX5-B6 is an updated stand-alone model with more features than the SX5-B. Use the SX5-B6 model in new installations of stand-alone systems.



# Industrial Wireless Solutions

## DXMR90 Industrial Controllers



Ethernet Connection	Master Connections	Other Connections	Models
One female M12 D-Code Ethernet connector	Four female M12 connections for Modbus	One male M12 (Port 0) for incoming power and Modbus RS-485, one female M12 for daisy chaining Port 0 signals	<b>DXMR90-X1</b>

## DXM700 Industrial Controllers



Family	Base	Radio Configuration
<b>DXM700</b>	<b>B1</b>	<b>R1</b>

**B1** = Modbus controller for data aggregation of sensors and wireless networks  
 Power: 12–30 V DC  
 Comms: RS-485, secondary RS-485  
 Outputs: Four PNP  
**B2** = Modbus controller for data aggregation of sensors and wireless networks  
 Power: 12–30 V DC  
 Comms: RS-485, secondary RS-485  
 Outputs: Four PNP  
 Connection: Barrel jack power connector

**Blank** = None  
**PTL** = Pre-programmed DXM700 for Pick-to-Light integration (no radio)  
**R1** = 900 MHz, 1 W PE5 performance radio (North America)  
**R2** = 900 MHz, 1 W HE5 MultiHop data radio (North America)  
**R3** = 2.4 GHz, 65 mW PE5 performance radio (Worldwide)  
**R4** = 2.4 GHz, 65 mW HE5 MultiHop data radio (Worldwide)  
**R5** = 900 MHz, 65 mW HE5L MultiHop data radio (used for M-GAGE networks)

## DXM1200 Industrial Controllers



Family	Base	Radio Configuration
<b>DXM1200</b>	<b>B1</b>	<b>R1</b>

**Blank** = Low-profile housing, one 4-pin M8 Ethernet connector, one 5-pin M12 power and RS-485 connector  
**E** = Extended housing, one 4-pin M12 D Code Ethernet connector, one 5-pin M12 power and RS-485 connector, two 5-pin M12 RS-485 connectors

**B1** = Modbus controller for data aggregation of sensors and wireless networks  
 Power: 12–30 V DC  
 Comms: RS-485

**Blank** = None  
**R1** = 900 MHz, 1 W PE5 Performance Radio (North America)  
**R2** = 900 MHz, 1 W HE5 MultiHop Data Radio (North America)  
**R3** = 2.4 GHz, 65 mW PE5 Performance Radio (Worldwide)  
**R4** = 2.4 GHz, 65 mW HE5 MultiHop Data Radio (Worldwide)

## Direct Select Operator Interfaces



Inputs and Outputs	Supply Voltage	Frequency	Models
Multicolor capacitive touch/indicator with four buttons and a three-digit numerical LCD	3.6 V DC C cell internal battery	900 MHz ISM Band	<b>DX80N9DSTS</b>
		2.4 GHz ISM Band	<b>DX80N2DSTS</b>
	10 V DC to 30 V DC	900 MHz ISM Band	<b>DX80N9DSTS-QD</b>
		2.4 GHz ISM Band	<b>DX80N2DSTS-QD</b>

## Q45 All-in-One Integrated Vibration and Temperature Sensors



Description	Frequency	Models
One c-cell battery	2.4 GHz	<b>DX80N2Q45VAC</b>
	900 MHz	<b>DX80N9Q45VAC</b>

## Q45PS All-in-One Pressure Sensors



Radio Frequency	Inputs and Outputs	Models
900 MHz ISM Band	Q45 with integrated 0–15 psi gauge pressure sensor	<b>DX80N9Q45PS15G</b>
	Q45 with integrated 0–50 psi gauge pressure sensor	<b>DX80N9Q45PS50G</b>
	Q45 with integrated 0–150 psi gauge pressure sensor	<b>DX80N9Q45PS150G</b>
	Q45 with integrated 0–250 psi gauge pressure sensor	<b>DX80N9Q45PS250G</b>
	Q45 with integrated 0–500 psi sealed gauge pressure sensor	<b>DX80N9Q45PS500S</b>
	Q45 with integrated 0–1000 psi sealed gauge pressure sensor	<b>DX80N9Q45PS1000S</b>
	Q45 with integrated 0–3000 psi sealed gauge pressure sensor	<b>DX80N9Q45PS3000S</b>
2.4 GHz ISM Band	Q45 with integrated 0–500 psi sealed gauge pressure sensor	<b>DX80N2Q45PS500S</b>
	Q45 with integrated 0–3000 psi sealed gauge pressure sensor	<b>DX80N2Q45PS3000S</b>

## Q45 Nodes



Inputs and Outputs	Radio Frequency	Models
One 0–10 V analog input for use with any BWA-PRESSURE-SENSOR sensor product	900 MHz ISM Band	<b>DX80N9Q45UPSD</b>
	2.4 GHz ISM Band	<b>DX80N2Q45UPSD</b>

## Gauge Pressure Sensors



Measurement Range	Description	Connection	Models
0–50 PSI	Pressure sensor PS1G50, gauge, 1/4"-18 NPT port	1 meter cable with a 4-pin M12 male quick disconnect	<b>BWA-PRESSURE-SENSOR-50</b>
0–150 PSI	Pressure sensor PS1G150, gauge, 1/4"-18 NPT port		<b>BWA-PRESSURE-SENSOR-150</b>
0–500 PSI	Pressure sensor PS1S500, sealed gauge, 1/4"-18 NPT port		<b>BWA-PRESSURE-SENSOR-500</b>
0–3000 PSI	Pressure sensor PS1S3000, sealed gauge, 1/4"-18 NPT port		<b>BWA-PRESSURE-SENSOR-3000</b>



# Industrial Wireless Solutions

## QM30VT1 Vibration and Temperature Sensors



Housing	I/O	Connection	Models
Aluminium; IP67	Vibration and temperature using a 1-wire serial interface	2.09 m cable with 5-pin M12 male QD	<b>QM30VT1</b>
		150 mm cable with 5-pin M12 male QD	<b>QM30VT1-QP</b>

## R70 Data Radios



Communication Type	Frequency	Transmit Power	Models
Serial	900 MHz ISM Band	1 Watt	<b>R70SR9MQ</b>
	2.4 GHz ISM Band	65 mW (100 mW EIRP)	<b>R70SR2MQ</b>
Ethernet	900 MHz ISM Band	500 mW	<b>R70ER9MQ</b>
	2.4 GHz ISM Band	65 mW (100 mW EIRP)	<b>R70ER2MQ</b>

## S15S Temperature and Humidity Sensors



Female	Male	Connection	Models
Temperature and humidity	Modbus	Integral M12 quick disconnect	<b>S15S-TH-MQ</b>

# Barcode and Vision Solutions

## VE Smart Cameras

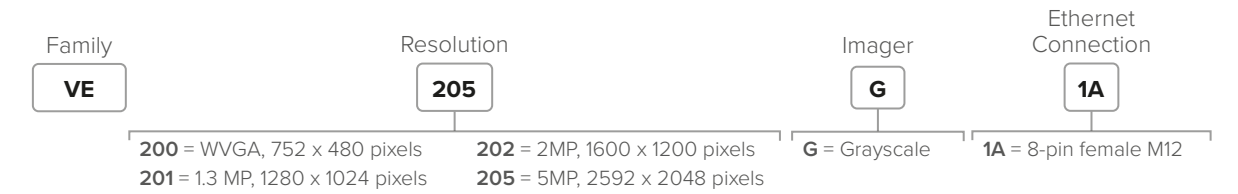

## iVu Vision Sensors

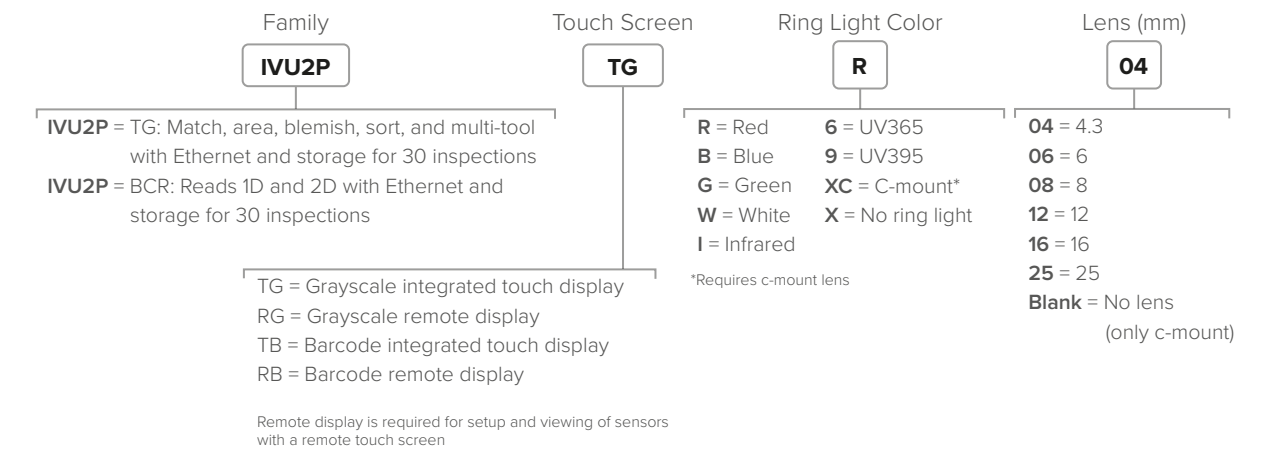

# Connectivity Technology Solutions

## S15C Converters

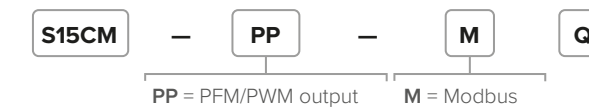
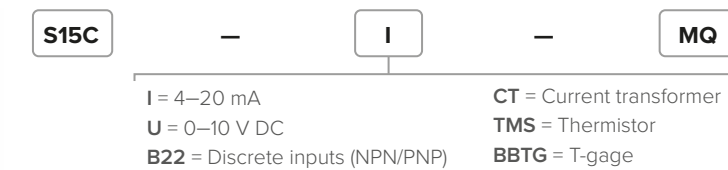
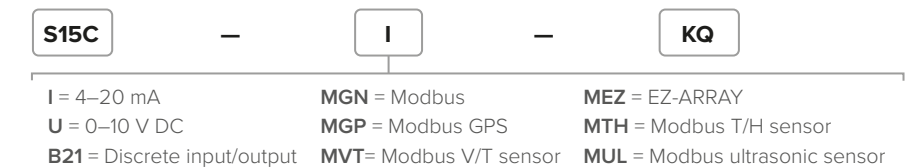



# Learn More About SNAP SIGNAL

## Monitor Your Factory Data in a Snap

Customers use Banner's Snap Signal hardware and software to instantly unlock valuable data from their equipment and increase productivity. This smart-factory portfolio forms an overlay network by capturing signals from existing and new devices, converting them to a unified protocol, and then distributing them to monitoring platforms, such as SCADA systems, the cloud, or a local PLC/HMI for consumption. The solution deploys easily by leveraging available information without disrupting your existing controls. This helps save you money, reduces downtime, and optimizes your operations.

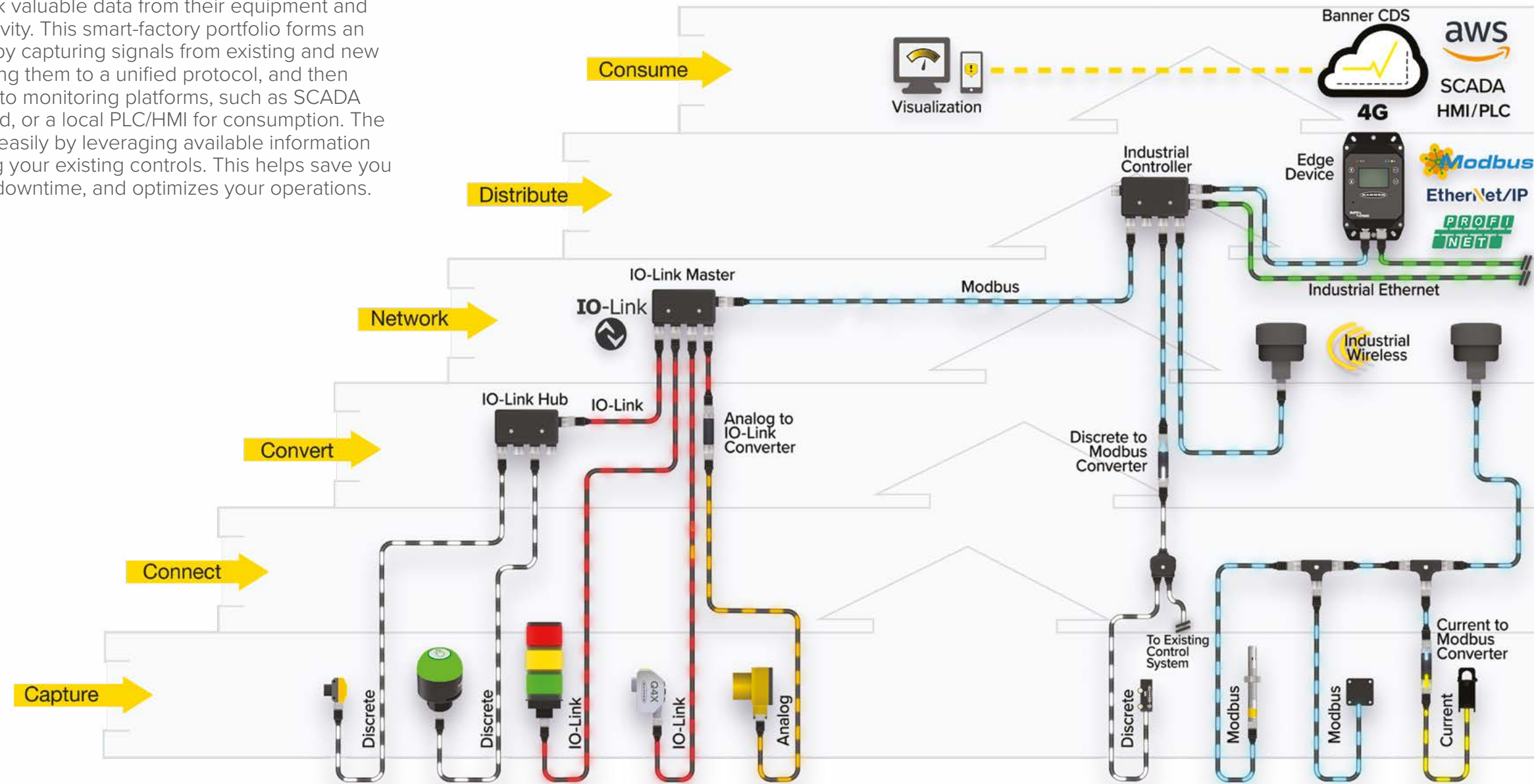



# More Sensors, More Solutions.

Banner Engineering designs and manufactures industrial automation products including sensors, smart IIoT and industrial wireless technologies, LED lights and indicators, measurement devices, machine safety equipment, as well as barcode scanners and machine vision. These solutions help make many of the things we use every day, from food and medicine to cars and electronics. A high-quality, reliable Banner product is installed somewhere around the world every two seconds. Headquartered in Minneapolis since 1966, Banner is an industry leader with more than 10,000 products, operations on five continents, and a world-wide team of more than 5,500 employees and partners. Our dedication to innovation and personable service makes Banner a trusted source of smart automation technologies to customers around the globe.

